

STOPPER

sistema guidalinee

IT nastro oppure cordone, moderno oppure classico? scegliete ciò che più preferite dal nostro ricchissimo programma di guidalinee stopper. assicuratevi inoltre ulteriori vantaggi espositivi grazie alla linea di accessori. stopper è la scelta giusta per tutti quelli che sanno dove andare.

personenleitsysteme

DE gurt oder seil, modern oder klassisch? wählen sie aus dem grossen angebot von stopper personenleitsystemen ihre ausführung. mit den stopper accessoires weitere vorteile sichern. stopper ist die richtige entscheidung für alle die wissen wo's lang geht.

crowd control

EN belt or rope, modern or classic? the large assortment of stopper will provide you with the crowd control you are looking for. gain further advantage and ensure efficiency with stopper accessories. stopper: have it your way!



							
stopper general information	technical details	stopper eco master point	stopper eco	stopper master	overall view eco & master	stopper point	print
206-209	210-211	212-213	214	215	216-217	218-219	220

							
insert inlay	stopper antipanic	stopper wall	stopper accessories	stopper tex general information	stopper tex alu	stopper tex	stopper tex double
221	222	223	224-225	226	227	228	229

					
tex cord	tex accessories	stopinfo	maginfo slim	rondo	cubo
230-231	232-233	234-235	236-237	238	239



Stopper® stand in line with italian design

 MADE IN EU design by KD



IT stopper è il sistema guida linee eliminate sviluppato e prodotto da kunst-dünger che sta ricevendo ampi consensi dalla clientela mondiale. ovunque ci siano da dirigere dei flussi di persone, stopper entra in azione: aeroporti, stazioni, centri commerciali, teatri, cinema, musei, stadi e durante manifestazioni culturali e sportive, ma anche in posta, in banca, presso le assicurazioni e in tutti gli uffici pubblici. in questi casi stopper assume due funzioni: direzione e sicurezza. strutturate e dirigitte il flusso di persone in attesa garantendone allo stesso tempo il diritto alla privacy, come per esempio succede agli sportelli. inoltre potete impedire l'accesso a luoghi interdetti al pubblico. la già vasta gamma viene ampliata continuamente. con il presente catalogo siamo in grado di fornirvi oltre 4500 possibilità di combinazioni standard, a vostra scelta, grazie ai materiali insoliti, ai nuovi colori e alla personalizzazione del nastro e della base con la stampa digitale. siamo inoltre volentieri a disposizione per ulteriori consigli e suggerimenti.

DE stopper das personenleitsystem von kunstdünger entwickelt und produziert, überzeugt kunden weltweit. wo immer menschen zusammenkommen ist stopper im einsatz: flughäfen, bahnhöfe, kaufhäuser, theater, kinos, museen, stadien, messen, kultur- oder sportveranstaltungen, sowie natürlich bei post, bank, versicherungen und behörden aller art. dabei übernimmt stopper zwei aufgaben: leiten und sichern. strukturieren und führen sie die wartenden und sichern sie zugleich privatsphäre z.b. am schalter. verhindern sie ausserdem unbefugtes betreten von nicht-öffentlichen bereichen. das sortiment wird von uns ständig weiterentwickelt. dieser katalog hat über 4500 mögliche standard-kombinationen für sie zur auswahl. ungewöhnliche materialien, neue farben oder die personalisierung von gurt und basis mit digitaldruck sind kein problem. fragen sie uns, wir beraten sie gerne.



EN customers worldwide choose stopper the crowd control system developed and produced by kunstdünger. wherever people come together, stopper is used: airports, railway stations, department stores, theaters, cinemas, museums, stadiums, fairs, cultural or sporting events as well as post offices, banks, insurers and offices of public authorities. on the job stopper serves two purposes: guiding and safeguarding. with stopper you guide and control the queue and guarantee privacy at the counter as well. furthermore stopper helps you to prevent trespassing into private areas. we continuously enhance the assortment. this catalogue offers you more than 4500 possible standard combinations to choose from. exceptional materials, new colours or customizing of webbings and bases with digital printing is no problem. we are looking forward to your particular request.



stopper



applications

MADE IN EU design by KD

Stopper®

solo vantaggi!

IT guidare le persone con stopper significa risparmio di spazio, guadagno di tempo e riduzione di stress. clientela e personale sono chiaramente più rilassati, gli spazi vengono usati in modo ottimale e le procedure si snelliscono.

nur vorteile!

DE menschen leiten mit stopper heisst platz sparen, zeit gewinnen und stress vermindern. wartende, wie personal sind deutlich relaxter, räume werden optimal genutzt und abläufe flüssiger.

only advantages!

EN guide persons with stopper means save space, win time and reduce stress. queuers and staff are definitely relaxter, premises are used better and the work flows gets smoother.

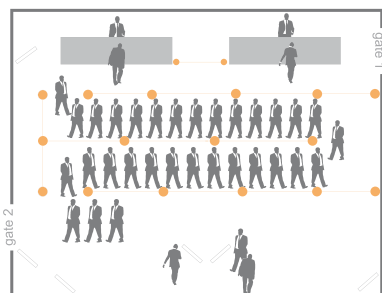
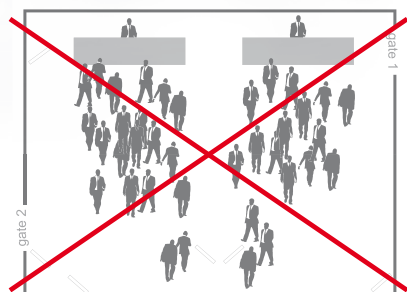



technical details

MADE IN EU design by KD

IT il meccanismo avvolginastro: in abs infrangibile, si monta senza l'utilizzo di viti o colle, mentre senza bisogno di ulteriori utensili il raccordo a 4 direzioni rende possibile l'aggiunta di altri stopper. tutte le parti visibili del raccordo e degli agganci sono senza spigoli, con forme rotondeggianti: per evitare ogni possibile ferita o danno agli abiti. il meccanismo avvolginastro in abs viene inserito nel tubo grazie alle scanalature laterali e al sistema autobloccante. per cambiare il meccanismo basta sganciare le molle grazie ai bottoncini laterali ed estrarlo.

DE die gurtkassette: aus bruchsicherem abs ohne schrauben und klebstoff montiert. an das 4-wege-gehäuse können sie weitere stopper anschliessen ohne zusätzliche adapter. alle hervorstehenden teile und sichtbaren kanten sind gerundet: keine verletzungsgefahr, kleidung kommt nicht zu schaden. das abs-gurtgehäuse wird in den pfosten eingeschoben und rastet sicher ein. zum austausch die verschlussfeder einfach per knopfdruck öffnen und gehäuse herausziehen.

EN the housing: made of breakproof abs plastics mounted unglummed and without screws. connect more stoppers to the 4-way housing without further adaptor necessary. all jutting parts and edges are rounded: no risk of injury, no damage to clothing. the housing made of abs plastics is simply inserted into the post and locks in safely. for changing just press the button to open and pull out the housing.



il cambio del meccanismo con nastro è possibile in ogni momento. a prova di manomissioni grazie al bottone di sicurezza nella parte inferiore del gancio.

austausch der gurtkassetten jederzeit ganz einfach möglich. manipulationsgeschützt dank sicherungsknopf.

quick and easy exchange of the housings at anytime. tamper-proof thanks to the security button.



estensione totale: nastro di 3 mt di lunghezza
vollauszug mit 3m gurtlänge

complete extension of webbing to 3m in length



fissaggio sicuro grazie all'inserimento del gancio nella scanalatura. il bottone inferiore rende impossibile lo sganciamento accidentale del nastro.

sichere befestigung durch einschubhaltung mit einrast-sicherung. sicherungsknopf schützt vor ungewolltem lösen der gurte.

fasten securely the webbing by inserting it to the housing. security button prevents accidental opening.

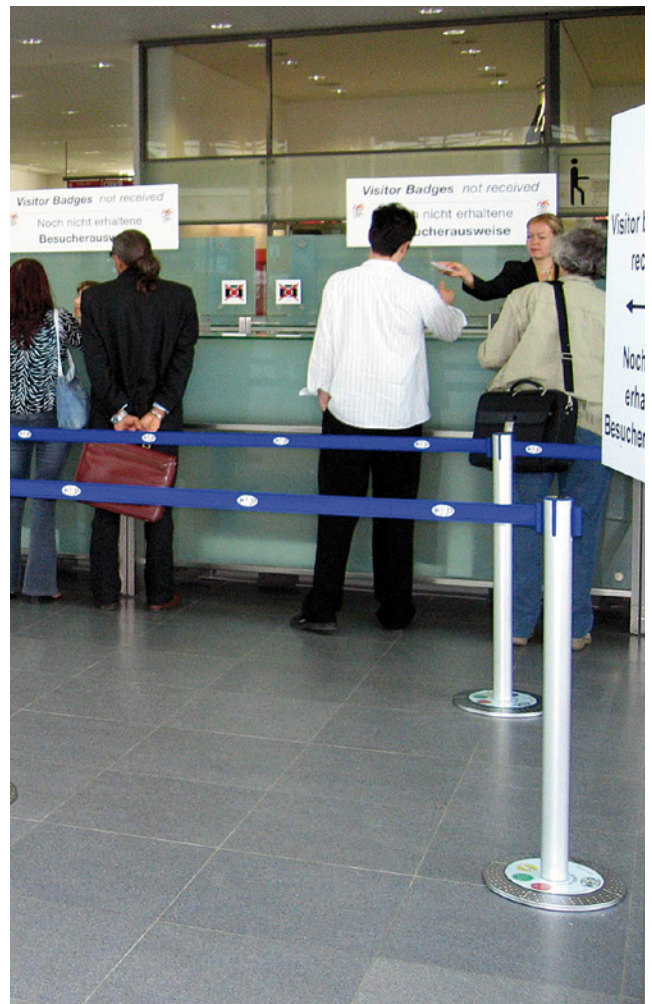

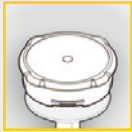

A filetto per accessori: foro filettato M8 per tutti gli accessori.
das gewinde: integriertes M8 gewinde für alle accessoires.
 thread for accessories: integrated M8 thread for all accessories.

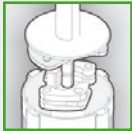

B il sistema frenante: integrato nel meccanismo, il freno regola la sua azione frenante in base alla velocità di rotazione dell'avvolginastro. il nastro viene riavvolto con la stessa velocità dall'inizio alla fine. si evitano così ferite alle mani e alle dita a causa di un riavvolgimento incontrollato e troppo veloce.

die bremse: die eingebaute fliehkraftbremse passt ihre bremsstärke an die rotationsgeschwindigkeit des mechanismus an. das gurtband wird von anfang bis ende mit gleicher geschwindigkeit eingezogen. keine hand- und fingerverletzungen durch unkontrollierte ausschläge des bandes beim einzug.

the brake: the integrated brake adjusts its force according to the rotation speed of the mechanism. the tape is pulled back with the same speed over the full length. no sudden punches of the tape and no risk to injure hand or fingers.

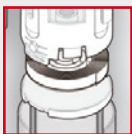

C la molla: appositamente per lo stopper abbiamo realizzato una speciale molla piatta in acciaio, con gli angoli arrotondati. il suo effetto si svolge linearmente su tutta la lunghezza del nastro. ciò significa che le colonnine rimangono stabili anche quando il nastro viene utilizzato per tutta la sua lunghezza e che il nastro stesso rimane perfettamente in tensione anche se usato solo per parte della sua lunghezza. con stopper avete la possibilità di utilizzare l'intera lunghezza di 3m in modo ottimale.

die feder: eigens für stopper haben wir eine stahl-flachfeder mit abgerundeten kanten entwickelt. ihre federwirkung verläuft linear. der zug auf den gurt wirkt immer gleichmässig. das heisst für sie: kein umfallen der pfosten durch zu starken zug bei vollauszug und ausreichende spannung auch bei geringem gurtauszug. mit stopper nutzen sie die gesamte gurtlänge von 3m optimal.

the spring: especially for stopper we designed a steel flat spring with linear resilience. the tape is under a constant tension. that means no toppling of the posts when the tape is completely moved out and enough tension even with little pullout to keep the tape straight. with stopper you use the full tape length of 3m.

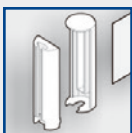

D il gancio di sicurezza: ogni nastro stopper è dotato di uno speciale gancio con una chiusura di sicurezza. il gancio si incastra sul raccordo del meccanismo ed impedisce che il nastro si stacchi inavvertitamente. per aprirlo basta premere leggermente il bottoncino. tale chiusura è standard in tutti i nastri disponibili. nelle prossime pagine troverete ulteriori vantaggi che vi offre il sistema stopper.

der verschluss: jedes gurtband hat einen verschluss mit sicherung. diese sicherung rastet ein und verhindert unbeabsichtigtes auslösen oder herausgleiten. zum öffnen genügt ein knopfdruck. diese sicherung ist standard bei allen gurtausführungen. noch mehr vorteile des stoppersystems finden sie auf den nächsten seiten.

the locking: every tape has a tamper-proof locking. this locking snaps in and prevents from unintended opening or sliding out. to open just press the button. this locking comes with all tape ends as a standard. find more stopper advantages on the following pages.

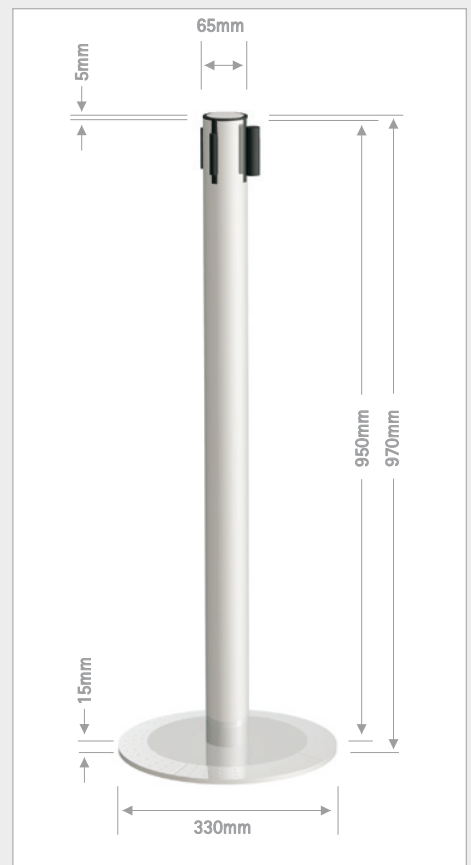
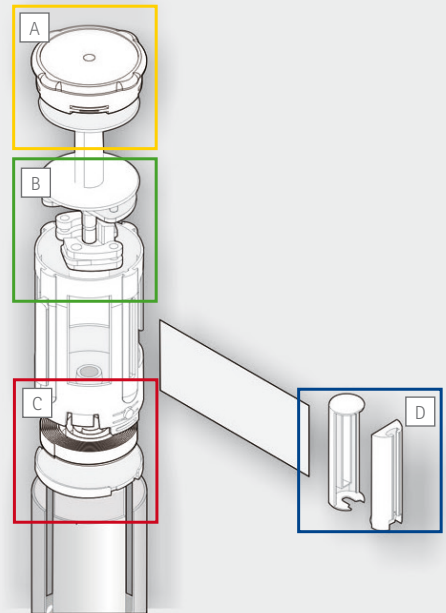



information

master

MADE IN EU design by KD

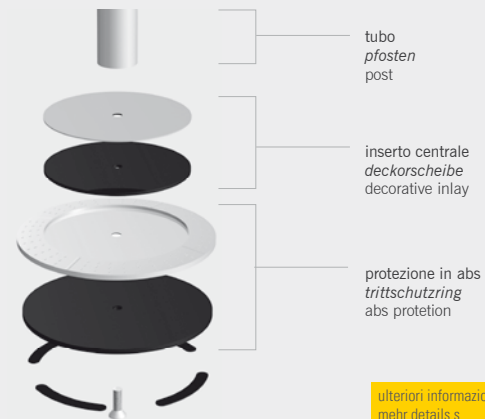
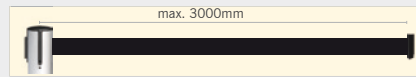

ulteriori informazioni pag.
mehr details s.
more information p.

215

eco

MADE IN EU design by KD

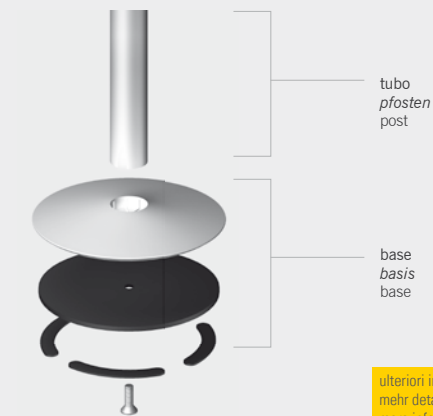
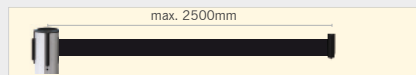

ulteriori informazioni pag.
mehr details s.
more information p.

214

point

MADE IN EU design by KD

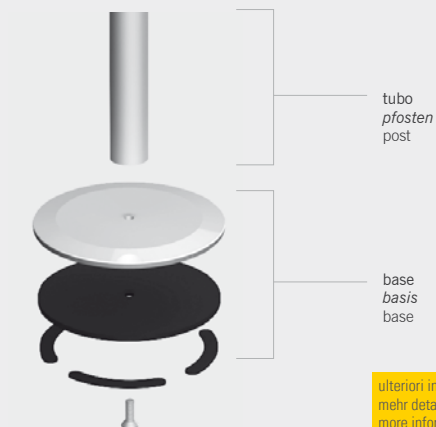
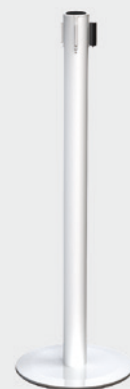

ulteriori informazioni pag.
mehr details s.
more information p.

218



Stopper® eco

 MADE IN EU design by KD

IT più leggera ed anche più economica è la variante minimalista della base stopper: disco in acciaio e copertura abs in diversi colori, combinabili con tutti i tubi e i nastri stopper. a causa della diminuzione del peso, la lunghezza del nastro è di massimo 2,5m.

DE leichter und günstiger präsentiert sich die ökonomische und schlanke variante der stopperbasis: stahlplatte und abs-abdeckung in diversen farben kombinierbar mit allen stopper pfosten und gurten. aufgrund des verringerten gewichts ist der gurtauszug auf 2,5m limitiert.

EN lighter and more economic is the leaner version of the stopper base: steel weight plate with abs cover in different colours combinable with all stopper posts and webbings. due to the reduced weight the webbing pull out is limited to 2,5m.

a scelta libera
ihre freie auswahl
your free choice

216-
217

max. 2500mm

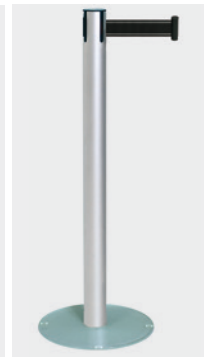



Stopper master

 MADE IN EU design by KD

IT molteplicità d'uso, flessibilità e sicurezza: tutto questo è il sistema modulare e componibile stopper. la base è composta da un rivestimento esterno e di protezione in abs, da piastre in acciaio per dare stabilità al sistema e da inserti centrali decorativi in diverse finiture. il punto forte e la novità assoluta sono gli inserti centrali in vetro: facili e veloci da personalizzare grazie alla stampa digitale!

DE vielfalt, flexibilität, sicherheit: das modulare stopper-system. die basis besteht aus einem abs-trittschutz-ring, stahlplatten für sicheren stand und dekorscheiben in diversen ausführungen. der besondere clou sind die dekorscheiben aus sicherheitsglas: mit digitaldruck schnell personalisiert!

EN variety, flexibly, security: the modular stopper-system. the base is composed by a step-on protection ring made of abs plastics, steel-plates for firm standing and decorative plates in different versions. exceptional are the decorative plates made of tempered glass: with digital printing easily customised!

a scelta libera
ihre freie auswahl
your free choice

216-
217

max. 3000mm



overall view *Stopper* eco & master

a scelta libera

IT più di 4.500 possibilità per creare il vostro stopper preferito! componete il vostro stopper: A meccanismo avvolginastro + B tubo per la base master + C inserto centrale + D protezione in abs o E per la base eco / la base in vetro.

ihre freie auswahl

DE mehr als ungläubliche 4.500 möglichkeiten für ihr ganz persönliches stoppersystem! kombinieren sie: A gurtmechanismus + B pfoften und für die master basis C dekorscheibe + D trittschutzring oder E für die eco basis bzw. die glasbasis.

your free choice

EN more than 4.500 incredible ways to create your favoured stopper guideline system! just choose your combination: A housing + B post and for the master base C insert + D abs protection or E for eco base resp. the glass base.



+

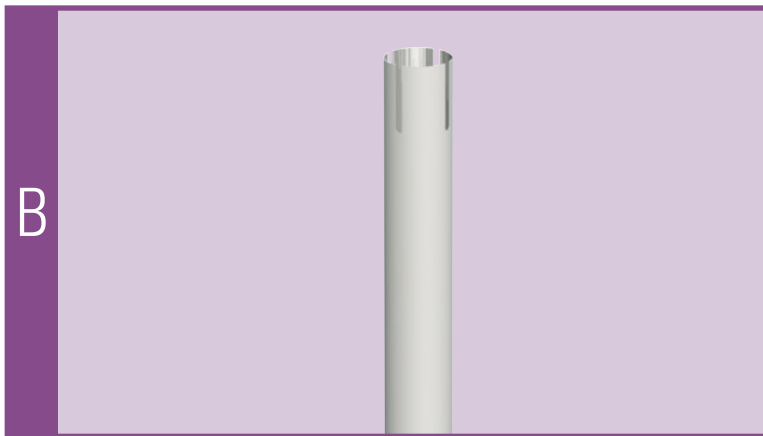

+

or

+

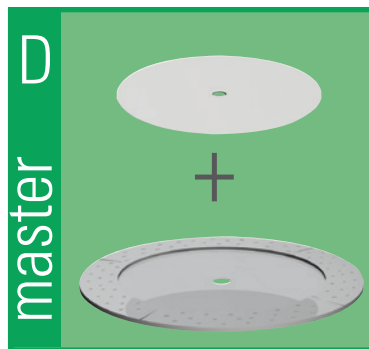
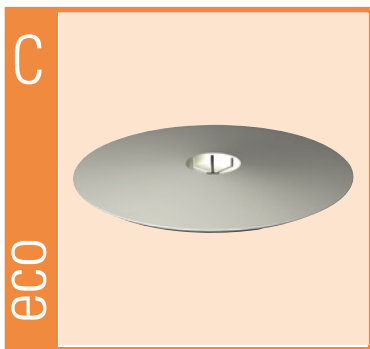

	base basis base
C	STE330SZ
	nero/schwarz/black
	eco
	grigio chiaro /lichtgrau/ light grey
	STE330VE
	vetro/glas/glass
	STE330CM
	cromo/chrom/chrome

eco base:
a causa della diminuzione del peso, lunghezza del nastro max. 2,5m
aufgrund des geringeren gewichts gurtzug max. 2,5m
due to the reduced weight webbing pullout is max. 2,5m

A

meccanismo avvolginastro vuoto | leeres gurtgehäuse | empty housing



meccanismo blu + nastro | gehäuse blau + gurt | housing blue + webbing



il prezzo comprende: meccanismo avvolginastro + nastro | die preise beinhalten gehäuse + gurt | the price comprehensive housing + webbing

meccanismo nero + nastro | gehäuse schwarz + gurt | housing black + webbing

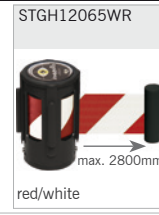

il prezzo comprende: meccanismo avvolginastro + nastro | die preise beinhalten gehäuse + gurt | the price comprehensive housing + webbing

B

tubo | pfosten | post



D

base | basis | base

inserto centrale | dekorscheibe | decorative inlay

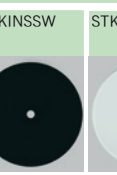
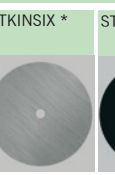

protezione in abs | trittschutzring | abs protection

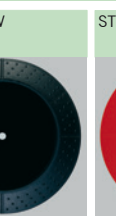

master

* fino ad esaurimento scorta | solange vorrat reicht | while stock last

** tubo nichelato, spazzolato, verniciato trasparente con effetto acciaio inox | oberflächenveredelung: nickel matt, gebürstet mit transparent-lack für edelstahl-effekt | post: nickel-plated matt brushed surface, transparent varnished finish for stainless steel look



Stopper point

 MADE IN EU design by KD

IT stopper point colpisce ed attira l'attenzione grazie alla sua forma moderna e sportiva. il design senza tempo del tubo e della base regalano a stopper point un'apparenza generale di eleganza e sobrietà. stopper point è la soluzione universale, ma comunque di bell'aspetto, per tutte le esigenze di delimitazione di flussi di persone. e proprio nelle peggiori condizioni di utilizzo, il nastro stopper resistente alle grinze mostra maggiormente i suoi vantaggi. disponibile solo in set completo nelle combinazioni alu o nero.

DE stopper point besticht durch moderne, sportive formgebung. zeitloses design von pfosten und basis zeigt ein einheitliches und elegantes gesamtbild. stopper point ist die universelle und doch optisch gefällige absperrlösung für die unterschiedlichsten ansprüche. gerade bei hoher belastung zeigt das knitter-resistente gurtband seine vorzüge. erhältlich nur als komplettset in kombination alu oder schwarz.

EN stopper point wins everyone over because of its modern and sports casual design. the timeless shape of the post and base gives stopper point a consistent yet elegant look. stopper point is the universal choice for different requirements. especially under high impact the crease resistant webbing has its advantages. available only as complete set in the combination black or alu.

information

nastro: resistente alle grinze
gurtband: anti knitter
webbing: anti-crease

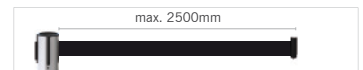

stopper point

1	SCPALARGSW	point alu with black ribbon, 1pc
2	SCPSSWSSW	point black with black ribbon 1pc



1

set stopper
point alu

meccanismo grigio chiaro, nastro nero-grigio, tubo in alluminio anodizzato e base in argento satinato.

lichtgraue kassette, schwarz-grauer gurt, eloxiertes alu und kunststoff basis in silbermatt.

light grey housing, black-grey webbing, anodized aluminium and synthetic base in matt silver



2

set stopper
point black

meccanismo nero, nastro nero-grigio, tubo e base in nero satinato.

schwarze kassette, schwarz-grauer gurt, pfosten und basis in schwarz matt.

black housing, black-grey webbing, post and synthetic base in matt black





print

MADE IN EU design by KD



IT dirigete con stopper e approfittate di un nuovo spazio pubblicitario: il nastro è personalizzabile con serigrafia o stampa digitale. raccomandiamo la serigrafia per loghi aziendali o scritte semplici; con la stampa digitale invece potremo realizzare per voi immagini in policromia e di maggiore impatto grafico. la stampa digitale, inoltre, permetterà di stampare a tutta superficie il colore della vostra azienda. per ulteriori dettagli non esitate a contattarci, saremo sempre a vostra completa disposizione.

DE zeigen sie mit stopper wo's langgeht und nutzen sie die möglichen zusätzlichen werbeflächen. der gurt kann mit siebdruck oder digital personalisiert werden. für einfache logos und schriftzüge empfehlen wir den siebdruck, während mit digitaldruck vielfarbigkeit und tolle effekte realisiert werden. sie können den gurt z.b. auch in der farbe ihres firmen corporates bedrucken lassen. dies empfiehlt sich auch bei geringen stückzahlen. fragen sie uns, wir beraten sie gerne.

EN show the way with stopper and use additional advertising space. the webbing can be customized with serigraphy or digital printing. for simple logos and words we recommend screen printing, while digital printing can make polychrome and sophisticated designs. you can also print the webbing to match your company's corporate colours. even small quantities are not a problem. ask us for more detailed information.



information



personalizzazione del nastro con stampa digitale o serigrafia.
non esiti a contattarci, saremo sempre a sua completa disposizione!

personalisierung der gurte mit sieb- oder digitaldruck.

fragen sie uns, wir beraten sie gerne!

personalisation of the webbing with silkscreen or digital print. ask us, we will gladly provide you with all necessary details!

- ✓ free layout
- ✓ photo-quality
- ✓ colour-fast



insert | inlay

MADE IN EU design by KD



stopper

IT utilizzate il vostro stopper per attirare l'attenzione: il tubo in policarbonato trasparente e antiurto diventa una superficie pubblicitaria aggiuntiva oppure un decorativo espositore per oggetti. togliete il meccanismo avvolginastro ed inserite nel tubo una stampa digitale o dei piccoli oggetti. grazie alla speciale struttura il contenuto del tubo si può cambiare a piacere ed in ogni momento. inoltre, l'effetto pubblicitario è ulteriormente accentuato grazie alla speciale base stopper, anch'essa personalizzabile a piacere e velocemente.

DE nutzen sie ihr stoppersystem als hingucker: der pfosten aus transparentem, schlagfestem polycarbonat wird zur zusätzlichen werbefläche oder einem dekorativem objektpräsentier. sie nehmen den gurtmechanismus ab und bestücken den pfosten mit einem druck oder kleinen objekten. durch die spezielle konstruktion lässt sich der inhalt schnell und einfach jederzeit austauschen. mit dem glaseinsatz der basis steigern sie diesen marketing effekt noch: auch sie lässt sich jederzeit schnell und einfach mit print personalisieren.

EN make your stopper an eye catcher: the post made of transparent, shock-resistant polycarbonate becomes an additional advertising space or a stylish item display. just unscrew the webbing mechanism and fill the post with a print or small items. thanks to the particular design the content can be exchanged easily anytime. and with the special stopper base glass inset you can boost your marketing effect even more: customize the base with a print in no time at all.

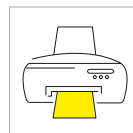
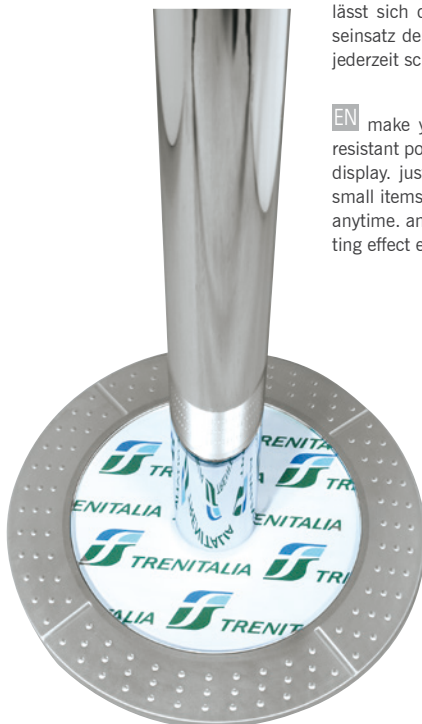
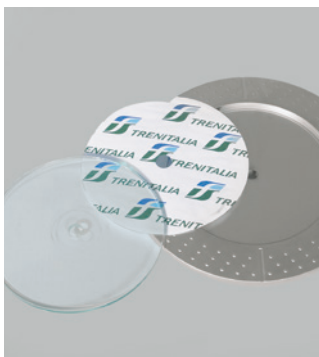

create e stampate il layout semplicemente con il tuo pc

layout am eigenen pc gestalten und ausdrucken

design and print with your own workstation

Stopper® antipanic

MADE IN EU design by KD

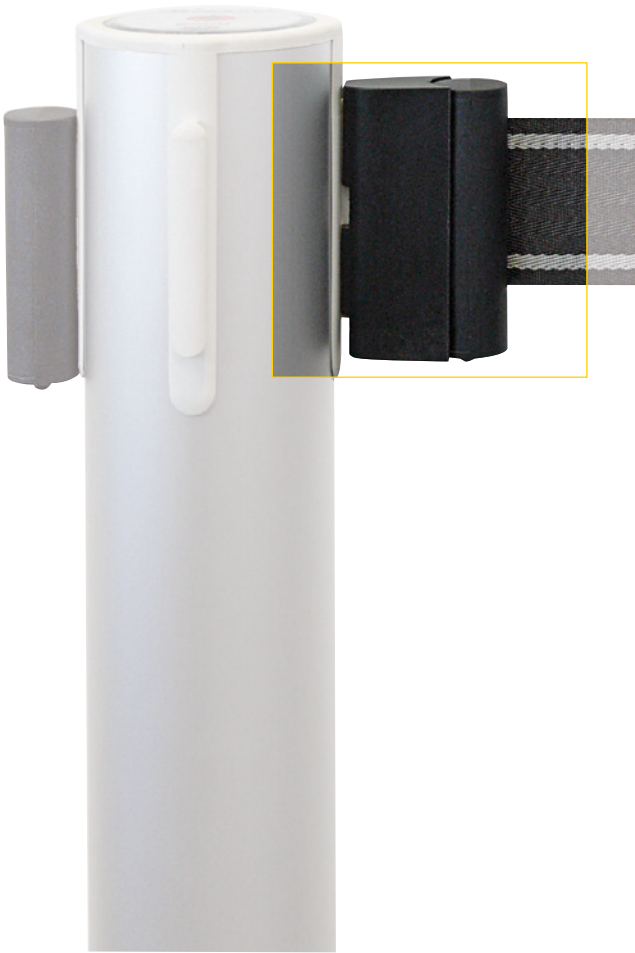

IT stopper antipanic è il completamento ideale per la gamma di colonnine eliminacode stopper. L'adattatore può essere utilizzato e aggiunto a tutti i meccanismi con nastro della linea. La chiusura magnetica è strutturata in modo tale da svolgere perfettamente le due funzioni richieste: durante il normale utilizzo il nastro resta ben tensionato, in caso di una spinta o di pressione sul nastro, il gancio si stacca immediatamente. Ideale soprattutto per stopper installati presso entrate, uscite o passaggi con grande flusso di pubblico, stopper antipanic è un must tecnologico e di sicurezza che non si può trascurare.

DE stopper antipanic ist die perfekte ergänzung für ihr stopper personenleitsystem. der adapter kann jederzeit an alle stopper gurtkassetten angebracht werden. sein magnetverschluss ist so eingestellt, dass der gurt bei normalem betrieb sicher hält, bei entsprechendem abruptem druck jedoch sofort öffnet. vor allem bei festinstallierten stoppern vor ausgängen ein sicherheitstechnisches muss.

EN stopper antipanic is the perfect supplement for your stopper crowd control. the adapter can be mounted anytime to all our stopper webbing houses. the magnetic lock will hold the webbing safely under normal conditions, but will open immediately under abrupt pressure. antipanic is ideal for permanently installed stopper systems in front of exits, the antipanic adapter is a must to ensure public safety.



abs di colore nero, con chiusura magnetica.
 schwarzer abs kunststoff mit magnet.
 black abs with magnet.

information

niente panico: la chiusura magnetica si rilascia in caso di emergenza

keine panik: magnet öffnet im notfall

no panic: the magnet opens in case of an emergency



stopper antipanic

1 STAP70SZ

adapter antipanic black, 1pc



Stopper wall

MADE IN EU design by KD

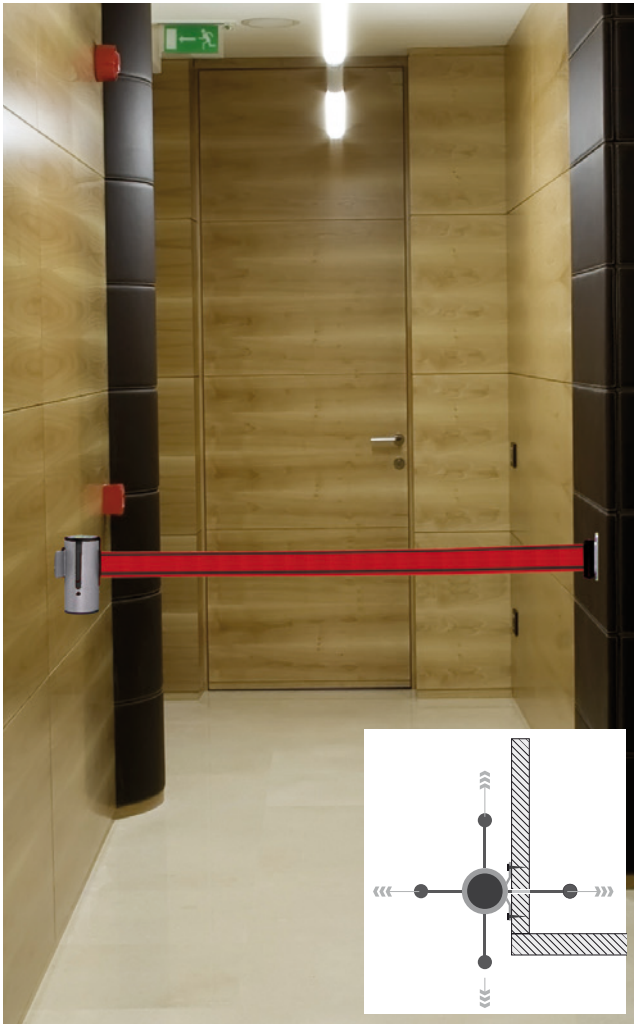

stopper

IT attacco a parete stopper: con l'attacco a parete avete a disposizione lo stesso raccordo a 4 direzioni delle colonnine a terra, ma non solo: il nastro infatti potrà fuoriuscire dall'attacco a parete sia sul fronte che di lato, ma anche dalla quarta via d'uscita, posteriore, nel caso in cui l'attacco a parete venisse montato in un luogo nascosto dietro ad un muro o ad un mobile, per esempio. l'attacco a parete insomma si fa notare solo se serve e nel caso in cui debba essere utilizzato, altrimenti rimarrà nascosto. completate il fissaggio del nastro montando alla parete l' attacco „stopper clip „ oppure agganciatelo al meccanismo di un' altra colonnina stopper.

DE ohne pfosten und basis: mit der wandhalterung steht ihnen auch das komplette 4-wege system von stopper zur verfügung. nicht nur die auszüge parallel und rechtwinklig zur montagefläche, sondern auch der 4. auszug rückseitig. den 4. auszug setzen sie dann ein, wenn sie die wandhalterung verdeckt montieren. hinter trockenbauwänden oder in möbeln installiert, macht sich ihr stopper dann nur im bedarfsfall bemerkbar. alle stopper-gurtkassetten passen in den wandhalter. als gegenstück zum einhängen des gurtes, wandmontieren sie einfach den stopper clip. je nach räumlicher gegebenheit können sie natürlich auch an ein stopper pfosten-element anschliessen.

EN no post, no base: use the 4-way system of stopper also with wall mount. you can use the pullouts forward or parallel to the wall and the 4th direction backwards as well. this direction is used when you mount the supports hidden behind walls or integrated in furniture. as counterpart just wallmount the stopper clip. depending on the location you can, of course, also connect the webbing to another stopper post.



1 2
attacco a parete in cromo lucido STWH130CM oppure in argento satinato STWH130AR, comprensivo di viti e tasselli per il montaggio.

stopper wandhalterung hochglanz verchromt STWH130CM oder silbermatt veredelt STWH130AR, inkl. schrauben und dübel für die wandmontage.

stopper wall support high-gloss chrome-plated STWH130CM or silver satined STWH130AR, incl. screws and dowels for mounting.



3
stopper clip a muro in ottone nichelato, comprensivo di viti e tasselli per il montaggio.

stopper wandclip messing vernickelt inkl. schraube und dübel für die wandmontage.

stopper wallclip, nickel-plated brass, incl. screws and dowels for mounting.

stopper wall

1	STWH130CM	stopper wall mount chrome-plated, 1pc
2	STWH130AR	stopper wall mount silver coated, 1pc
3	STWC90	stopper wallclip, 1pc

Stopper® accessories

MADE IN EU design by KD



4
stopquick



IT moltiplicate le funzioni del vostro sistema stopper, attacco a parete o tex. evitare il sostegno universale ad U alla colonnina, scegliere ed inserire i supporti in acrilico nel sostegno ad U. tutti i supporti sono intercambiabili. il nostro consiglio: tali supporti in acrilico sono compatibili anche con flip e flippy, della linea zip.

DE erweitern sie mit den stopper accessoires stopper, stopper wandhalter oder tex. universal haltebügel stophold einfach aufgeschraubten, das passende acrylglas-display auswählen und einschieben. displays können jederzeit gewechselt werden. unser tip: alle displays passen auch zu flip und flippy der zip serie.

EN upgrade your stopper, stopper wall or tex system with the accessories. stophold support is simply screwed on all stopper versions. then choose the needed acrylic glass display and insert it into stophold. you can replace the displays anytime. our tip: all displays match also with the zip items flip and flippy.



1

stophold sostegno cromo lucido, 230mmx-250mm (hxb).

stophold haltebügel, hochglanz- verchromt, 230mmx250mm (hxb).

stophold display holder, high-gloss chrome-plated, 230mmx250mm (hxb).

information

avvitare stophold alla colonnina, scegliere ed inserire i supporti in acrilico nel sostegno ad U.

stophold einfach aufgeschraubten, das passende acrylglas-display auswählen und einschieben.

stophold support is simply screwed on all stopper versions. choose the needed acrylic glass display and insert it into stophold.



stopper accessories

1	STH250230CM	stophold, 1pc
2	STB305240GL	stopbag, 1pc
3	STU305240GL	stopup, 1pc
4	STQ302240GL	stopquick, 1pc
5	STPQ1A4	stoppix one side, 1pc
6	STF302240GL	stopfix, 1pc





2
stopbag

1
staphold



staphold excl.

stopbag tasca portadepliant in acrilico color vetro, spessore 3mm, per formato DIN A4, inclinata di circa 30°, adatta per circa 200 fogli singoli.

stopbag acrylglas prospekttasche, 3mm, DIN A4 format, 30° neigung für ca. 200 einzelblattprospekte.

stopbag glassgreen acrylic brochure pocket, thickness 3mm for DIN A4 format, inclination 30° for approx. 200 single sheet brochures.

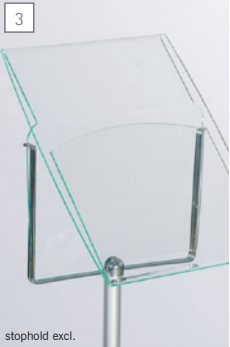

staphold excl.

stopup portaposter a tasca in acrilico color vetro, spessore 3mm, per formato DIN A4, inclinato di 45°, inserimento del foglio laterale.

stopup acrylglas-posterhalter 3mm stark für ein einzelblatt im DIN A4 format, 45° neigung, seitlicher einschub.

stopup glassgreen acrylic poster holder, thickness 3mm, for one single sheet in DIN A4 format, inclination 45°, insertion sideways.



staphold excl.

stopquick portaposter a tasca in acrilico color vetro, spessore 3mm, per formato DIN A4, con calamita per la chiusura, verticale, mono e bifacciale.

stopquick acrylglas-posterhalter 3mm, für ein einzelblatt DIN A4 format, ein- und beidseitige ansicht, öffnung mit magnetverschluss.

stopquick glassgreen acrylic poster holder, thickness 3mm, for one single sheet in DIN A4 format, vertical, front and rear view, magnetic lock.



staphold excl.

stopstix A4 monofacciale e bifacciale: poster display privo di cornici, policarbonato trasparente.

stopstix A4 ein- und doppelseitig: rahmenloses posterdisplay, transparentes polycarbonat.

stopstix A4 single-sided: frameless poster display, transparent polycarbonate.



staphold excl.

stopstix pannello singolo per informazioni in acrilico color vetro, spessore 3mm, per formato DIN A4, mono e bifacciale, per cartelli di direzione e di indicazione.

acrylglas-infoschild stopstix im DIN A4 format, stehend, ein- und beidseitige ansicht, für individuelle gestaltung und beschriftung.

glass-green acrylic information sign stopstix in DIN A4 format, vertical, front and rear view, for individual design and print.



Stopper[®] tex

MADE IN EU design by KD

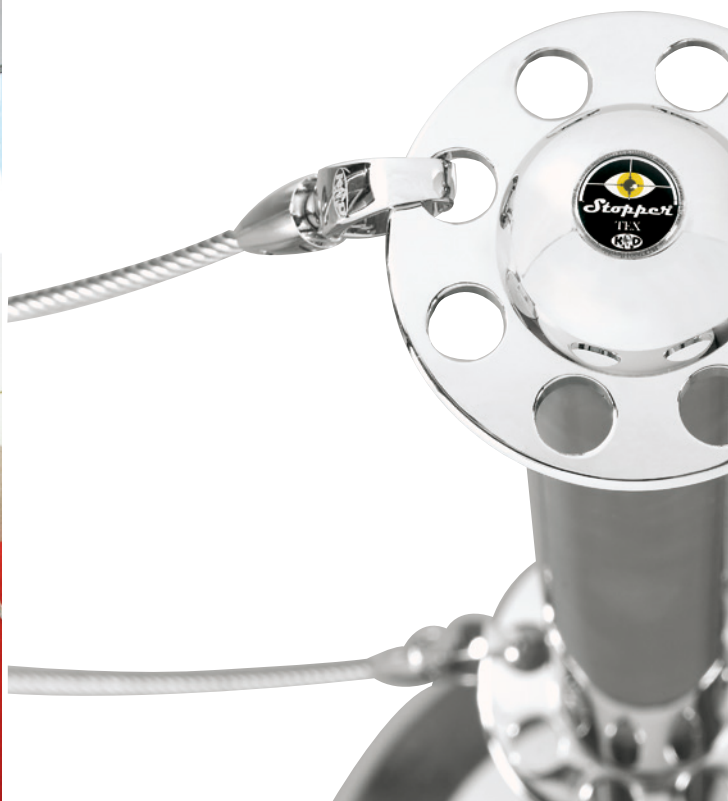

IT stopper tex é la variante classica del sistema guidalinee eliminacorde. grazie all'utilizzo di materiali nobili e ad una lavorazione di qualità, lo stopper tex è particolarmente indicato per gli ambienti eleganti di ricevimento, come le hall di un albergo, per le mostre e le rappresentazioni in musei o teatri o anche per dare un tocco di raffinata eleganza allo showroom. stopper tex mette a vostra disposizione la possibilità di agganciare fino a 8 corde ad una sola colonnina. i morsetti, eleganti e funzionali, rendono l'aggancio facile e sicuro. grazie al meccanismo di sicurezza dei morsetti non è possibile che si sgancino inavvertitamente. ogni stopper tex è dotato, nella parte superiore, di un foro filettato M8 per l'utilizzo degli accessori in programma

DE stopper tex ist die klassische variante des personenleitsystems. mit den edlen materialien in hochqualitativer verarbeitung empfiehlt sich stopper tex vor allem für das elegante ambiente im empfangsbereich, in hotelfoyers, für besondere ausstellungsstücke in museen oder im showroom. der pfosten bietet acht möglichkeiten die seile einzuhängen. formschöne clips rasten einfach und sicher ein. durch den karabiner-effekt wird unbeabsichtigtes lösen verhindert. alle stopper tex haben ein M8 gewinde passend für alle elemente des stopper zubehörprogramms.

EN stopper tex is the classic way of crowd control. high class material with high quality finish characterises stopper tex. especially for the elegant ambience in reception areas or hotel foyers as well as for exceptional exhibits in museums or showrooms stopper tex is recommended. the post has eight openings to hang in the rope. shapely clips make the attaching easy and safe. the karabiner-like closing prevents from unintended opening or sliding out. all stopper tex have a M8 thread suitable for all elements of the stopper accessories assortment.



Stopper[®] tex alu

MADE IN EU design by KD



stopper

IT tex alu rappresenta una versione economica e semplice, mantenendo tutti i vantaggi del sistema tex. l'alluminio di alta qualità del tubo non solo lo rende elegante ma anche resistente nel tempo. grazie allo speciale design la base del vostro tex alu è stabile e allo stesso tempo robusta. il supporto, comprensivo di 8 buchi per il cordone, e la semisfera sono rispettivamente in ottone color cromo lucido ed argento satinato. nelle pagine successive potrete trovare tutte le corde combinabili. anche stopper tex è comprensivo del filetto che permette di avvitare tutti gli accessori stopper.

DE tex alu bietet als ökonomische, schlanke version alle vorteile des tex-systems. das hochwertige silber eloxierte aluminium des pfostens sieht gut aus und ist dabei langlebig. durch das spezielle design der basis ist ihr tex alu stabil und widerstandsfähig zugleich. 8-loch seilhalter und halbkugel sind aus verchromtem bzw. versilbertem messing. die passenden seile finden sie auf den folgenden seiten. auch der tex alu ist mit einem passenden gewinde versehen, in das die stopper accessoires einfach eingeschraubt werden.

EN tex alu is a leaner and more economic version with all the advantages of the tex-system. the high-grade silver anodized aluminium makes the post not only look good but also durable. the special design of the base makes your tex alu stable and sturdy at the same time. the 8-hole cord support and the semisphere are made of chrome- resp. silver-plated brass. appropriate cords you'll find on the following pages. tex alu also comes with a thread matching for all stopper accessories.



tex alu

1	TXAL	set stopper tex alu, 1pc
2	TXALMI	set stopper tex alu mini, 1pc

information

tubo alluminio anodizzato, attacco corda ottone cromo lucido e argento satinato base sistema modulare con piastra ferro, copertura in abs grigio chiaro, inserto alluminio anodizzato color argento, ø240mm

pfosten eloxiertes aluminium, seilhalter messing verchromt und versilbert, modulare basis ø240mm mit grundplatte in eisen, abs-abdeckung lichtgrau, dekoreinsatz silber eloxiertes aluminium.

post anodized aluminium, cord support brass silver and chrome-plated base modular base ø240mm with iron plate, abs cover light grey, silver anodized aluminium inset

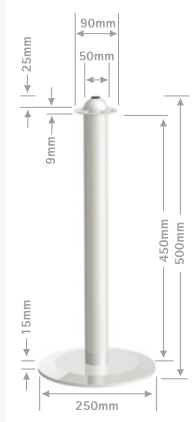
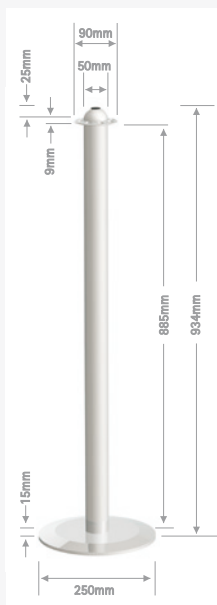

232

230

combinations



1
set stopper tex chrome-plated

set stopper tex: cromo lucido
set stopper tex: verchromt
set stopper tex: chrome-plated



2
set stopper tex brass-plated

set stopper tex: ottonato lucido
set stopper tex: vermessingt
set stopper tex: brass-plated

Stopper[®] tex

MADE IN EU design by KD

IT elegante, raffinato e di qualità: ecco come si presenta stopper tex. la base e il tubo sono realizzati in acciaio polito. la testina superiore è invece realizzata in ottone. tutte le parti che compongono stopper tex sono rifinite con una cromatura lucida di protezione. potete scegliere tra la versione in cromo lucido e la versione in color ottone lucido. stopper tex è alto 940mm e poggia in modo sicuro su una base del diametro di 250mm.

DE formschön und hochwertig präsentiert sich stopper tex. basis und pfosten sind aus poliertem stahl. das kopfteil aus messing-drehteilen. alle teile sind hochglanz verdelt. wählen sie zwischen der farbausführung in messing oder chrom. stopper tex ist 940mm hoch und steht sicher auf der basis mit 250mm durchmesser.

EN stopper tex introduces itself with elegance and high-grade materials. base and post are made of polished steel. the sphere is composed of turned brass pieces. all parts are high-gloss finished. choose between brass- or chrome-plated. stopper tex is 940mm high and stands firmly on the base with 250mm diameter.

information



tex

1	TXCM	set stopper tex chrome-plated, 1pc
2	TXOT	set stopper tex brass-plated, 1pc

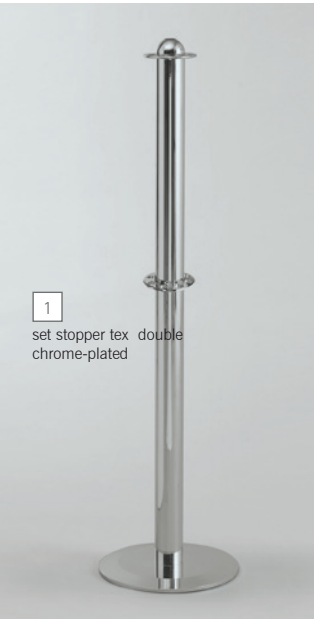

1
set stopper tex double
chrome-plated

tubo tex: cromo lucido con
doppio aggancio per corde

pfosten tex: verchromt mit
doppel-seilhalter

tex post: chrome-plated with
double cord support

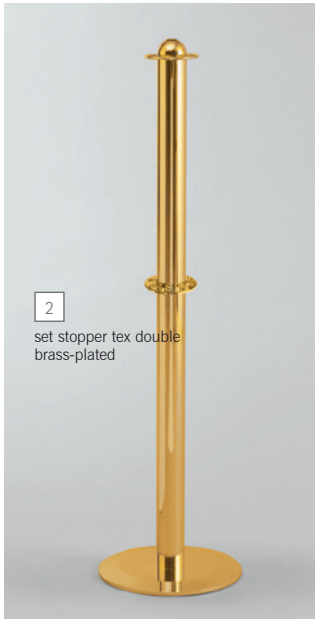

2
set stopper tex double
brass-plated

tubo tex: cromo lucido con
doppio aggancio per corde

pfosten tex: verchromt mit
doppel-seilhalter

tex post: chrome-plated with
double cord support

Stopper[®] tex double

MADE IN EU design by KD

IT grazie al doppio sistema di aggancio per le corde non raddoppiate solo la sicurezza ma anche l'effetto di stopper tex. il secondo aggancio è mobile e si può posizionare a piacere sulla colonnina, all'altezza desiderata. i due agganci sono compatibili con tutte le corde della nostra gamma. che sia con la classica corda in polipropilene o con il robusto cavo di acciaio, il nostro assortimento tex offre la soluzione giusta per ogni ambiente.

DE verdoppeln sie nicht nur die sicherheit, sondern auch die wirkung mit dem zweifachen seilhalter-system. der zweite halter ist verschiebbar und wird einfach auf die gewünschte höhe eingestellt. beide halter sind kompatibel mit allen seilen aus unserem programm. ob seile aus edelstahl oder farbigem polypropylen, unser tex sortiment bietet das richtige für jedes ambiente.

EN duplicate not only the security but also the look with the double rope support. the second support can move along the post and is simply adjusted to the desired height. both supports match with all our ropes. the tex assortment offers you ropes made of stainless steel and coloured polypropylen going with every ambiente.



tex double

1	TX2CM	set stopper tex double chrome-plated, 1pc
2	TX2OT	set stopper tex double brass-plated, 1pc

Stopper®

tex cord

MADE IN EU design by KD



morsetto in cromo lucido con clip nichelata.

seilkappe hochglanz verchromt mit karabiner-clip, vernickelt.

rope connector chrome-plated with nickel-plated carabiner.

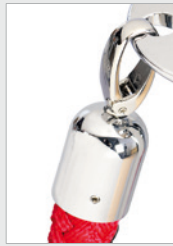

lunghezza länge length				
1 1000mm	TEXSCMBL100	TEXSCMRS100	TEXSCMSW100	TEXSCMGR100
2 1500mm	TEXSCMBL150	TEXSCMRS150	TEXSCMSW150	TEXSCMGR150
3 2000mm	TEXSCMBL200	TEXSCMRS200	TEXSCMSW200	TEXSCMGR200



morsetto in ottone lucido con clip nichelata.

seilkappe hochglanz vermessingt mit karabiner-clip, vernickelt.

rope connector brass-plated with nickel-plated carabiner.

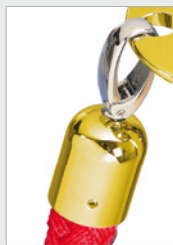

lunghezza länge length				
4 1000mm	TEXSOTBL100	TEXSOTRS100	TEXSOTSW100	TEXSOTGR100
5 1500mm	TEXSOTBL150	TEXSOTRS150	TEXSOTSW150	TEXSOTGR150
6 2000mm	TEXSOTBL200	TEXSOTRS200	TEXSOTSW200	TEXSOTGR200

morsetto in cromo lucido con clip nichelata.

seilkappe hochglanz verchromt mit karabiner-clip, vernickelt.

rope connector chrome-plated with nickel-plated carabiner.

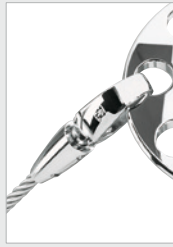

lunghezza länge length	
7 1000mm	TEXSCMIX100
8 1500mm	TEXSCMIX150
9 2000mm	TEXSCMIX200



10 **TEXWHCM**
gancio stopper tex per parete in cromo lucido conf. a 1pz incl. viti e tasselli
stopper tex wandhalter verchromt packg. 1st inkl. schrauben und dübel
stopper tex wallclip chrome-plated: package 1pc incl. screws and dowels

blu | blau | blue

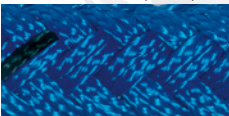

rosso | rot | red

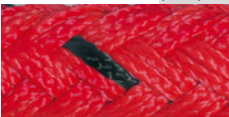

nero | schwarz | black

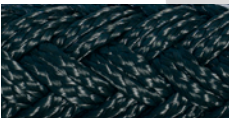

grigio | grau | grey



stainless steel



IT le corde in polipropilene vengono intrecciate appositamente per il nostro stopper tex. il materiale di cui sono composte non scolorisce ed è inoltre resistente a polvere e sporcizia. dalla nostra gamma potete scegliere 4 colori e 3 lunghezze standard. il morsetto è cromato lucido nelle finiture cromo e ottone. di particolare effetto é la nostra quinta variante, il cavo in acciaio inox. la clip vera e propria, nichelata, garantisce un sistema di chiusura che non può essere sganciato inavvertitamente.

DE speziell für stopper tex werden die seile aus polypropylen geflochten. das material ist farbecht sowie staub- und schmutzabweisend. sie können aus vier farben in jeweils drei standardlängen wählen. die seilkappe ist hochglanz vermessingt oder verchromt. der verschlusskarabiner in lackierter nickelausführung sorgt für einfache und sichere befestigung des seils.

EN exclusively for stopper tex the ropes are plaited in polypropylene. the material is colour fast as well as dust- and soil-resisting. the ropes come in four colours with three standard lengths. the rope connector is high-gloss chrome- or brass-plated. the rope is clipped safely and easily with the locking carabiner.





tex cord

1	cord 1000mm (all colours), chrome-plated support	1pc	
2	cord 1500mm (all colours), chrome-plated support	1pc	
3	cord 2000mm (all colours), chrome-plated support	1pc	
4	cord 1000mm (all colours), brass-plated support	1pc	
5	cord 1500mm (all colours), brass-plated support	1pc	
6	cord 2000mm (all colours), brass-plated support	1pc	
7	cord 1000mm, stainless steel	1pc	
8	cord 1500mm, stainless steel	1pc	
9	cord 2000mm, stainless steel	1pc	
10	TEXWHCM	wallclip chrome	1pc

altre lunghezze disponibili a richiesta | weitere längen auf anfrage | other sizes on demand



stophold sostegno cromo lucido, 230mmx-250mm (hxb)
 stophold haltebügel, hochglanz-verchromt, 230mmx250mm (hxb)
 stophold display holder, high-gloss chrome-plated, 230mmx250mm (hxw)



stopbag tasca portadepliant in acrilico color vetro, spessore 3mm, per formato DIN A4, inclinata di circa 30°, adatta per circa 200 fogli singoli.
 stopbag acrylglas prospekttasche, 3mm, DIN A4 format, 30° neigung für ca. 200 einzelblattprospekte.
 stopbag glassgreen acrylic brochure pocket, thickness 3mm for DIN A4 format, inclination 30° for approx. 200 single sheet brochures.



stopup portaposter a tasca in acrilico color vetro, spessore 3mm, per formato DIN A4, inclinato di 45°, inserimento del foglio laterale.
 stopup acrylglas-posterhalter 3mm stark für ein einzelblatt im DIN A4 format, 45° neigung, seitlicher einschub.
 stopup glassgreen acrylic poster holder, thickness 3mm, for one single sheet in DIN A4 format, inclination 45°, insertion sideways.



stopquick portaposter a tasca in acrilico color vetro, spessore 3mm, per formato DIN A4, con calamita per la chiusura, verticale, mono e bifacciale.
 stopquick acrylglas-posterhalter 3mm, für ein einzelblatt DIN A4 format, ein- und beidseitige ansicht, öffnung mit magnetverschluss.
 stopquick glassgreen acrylic poster holder, thickness 3mm, for one single sheet in DIN A4 format, vertical, front and rear view, magnetic lock.



stoppix A4 monofacciale e bifacciale: poster display privo di cornici, policarbonato trasparente.
 stoppix A4 ein- und doppelseitig: rahmenloses posterdisplay, transparentes polycarbonat.
 stoppix A4 single-sided: frameless poster display, transparent polycarbonate.



stopfix pannello singolo per informazioni in acrilico color vetro, spessore 3mm, per formato DIN A4, mono e bifacciale, per cartelli di direzione e di indicazione.
 acrylglas-infoschild stopfix im DIN A4 format, stehend, ein- und beidseitige ansicht, für individuelle gestaltung und beschriftung.
 glass-green acrylic information sign stopfix in DIN A4 format, vertical, front and rear view, for individual design and print.

tex accessories

MADE IN EU design by KD

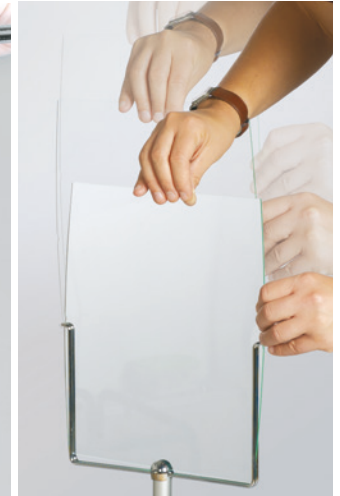

IT con gli accessori della nostra gamma potete moltiplicare le funzioni del vostro sistema tex: informare, presentare o fare pubblicità non sono un problema. il sostegno universale ad U viene semplicemente avvitato sulla testina dello stopper tex, già dotate a foro filettato per questo utilizzo. i supporti in acrilico si inseriscono facilmente nel sostegno ad U e altrettanto facilmente possono essere cambiati in qualsiasi momento.

DE erweitern sie ihren tex: informieren, präsentieren oder bewerben ist mit den accessoires kein problem. der universal haltebügel stophold wird aufgeschraubt. stopper tex hat bereits das passende gewinde. das passende acrylglas-display auswählen und einschieben. die displays können sie jederzeit wechseln.

EN upgrade your tex: informing, presenting or advertising is no problem with the stopper elements. the holder stophold is screwed onto the post. choose the needed acrylic display and insert it into stophold. the displays are exchangeable anytime.

tex accessories

1	STH250230CM	stophold, 1pc
2	STB305240GL	stopbag, 1pc
3	STU305240GL	stopup, 1pc
4	STQ302240GL	stopquick, 1pc
5	STPQ1A4	stoppix one side, 1pc
6	STF302240GL	stopfix, 1pc

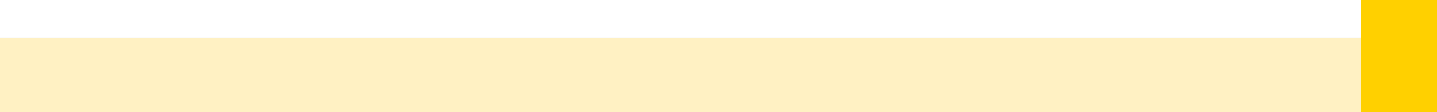

stopper



227-229



238



158

combinations



stopinfo soistes

MADE IN EU design by KD

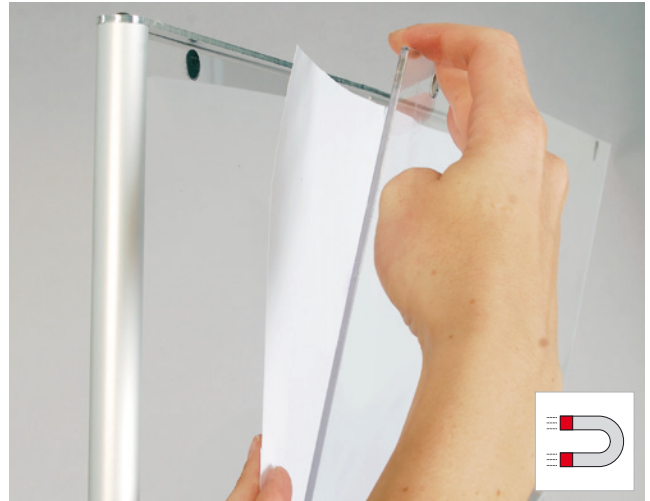

IT display per informazioni stabile e sicuro, con tasca portaposter fronte retro in acrilico trasparente. grazie alla chiusura con calamita, il cambio delle informazioni è semplice e possibile in ogni momento. stopinfo diventa in un batter d'occhio multifunzionale e personalizzabile con l'aggiunta di semplici accessori: sui 2 ripiani in acrilico satinato, in formato A4, potrete esporre la vostra documentazione, mentre le barre laterali danno la possibilità di esporre oggetti da appendere, come borse e lanyards, ma anche catenelle o appendiabiti. gli accessori vengono consegnati con le istruzioni per il montaggio, così che sia sempre facile e veloce personalizzare il vostro stopinfo a piacere.

DE stabiles info-display mit doppelseitiger postertasche in transparentem acrylglas. durch die bewährte quick-verschlusstechnik mit magnet ist der informationaustausch jederzeit und schnell erledigt. multifunktional und individuell wird ihr stopinfo mit unserem zubehör: auf der ablage für 2 A4 aus satiniertem acryl präsentieren sie printinfo zum mitnehmen, während die display bars platz bieten für aufhängbares wie taschen, lanyards oder auch ketten und kleiderbügel. das zubehör wird mit dem erforderlichen montagezubehör geliefert, so können sie ihren stopinfo jederzeit nach- und aufrüsten.

EN stable information display with double-side poster pocket in transparent acrylic. thanks to the approved magnetic closing system, poster exchange is simple and easy at any time. make your stopinfo a multifunctional and individual display with our accessories: the tray for 2A4 formats is perfect for your take-away print information while the display bars showcase suspended items like bags, lanyards, clothes on hangers, necklaces etc. accessories come already with mounting material, thus you can upgrade your stopinfo anytime.



ripiano per 2 depliant in A4 verticale, acrilico satinato, inclinabile orizzontalmente e posizionabile liberamente su tutta la lunghezza del profilo.

ablage für 2 A4 aus satiniertem acrylglas, horizontal neigbar und stufenlos höhenverstellbar
made of silver anodized aluminium

satin acrylic tray for 2 A4 sized literature, these trays are adjustable horizontally and in height.

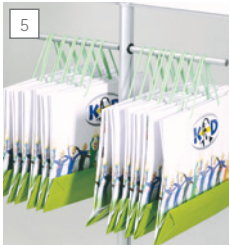

barre in alluminio anodizzato
stangen aus silber eloxiertem aluminium
bars made of silver anodized aluminium



information

tasca poster, alluminio anodizzato, base con protezione in abs cromato

acryl-postertasche, aluprofil eloxiert, verchromter abs-trittschutzring.

acrylic poster pocket, silver anodized aluminium extrusion, chrome-plated abs step-on-protection

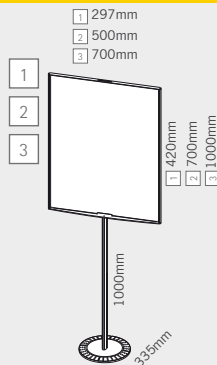

stopinfo soistes

1	STIFA3	stopinfo A3, 1pc
2	STIF700500	stopinfo 700x500mm, 1pc
3	STIF1000700	stopinfo 1000x700mm, 1pc
4	SOTR2A4TR	tray 2 A4 V, 1pc
5	SODB300	display bar, set with 2pcs



2 + 4

stopinfo 700x500mm + tray 2A4 V
price for this combination



stopper



ideas

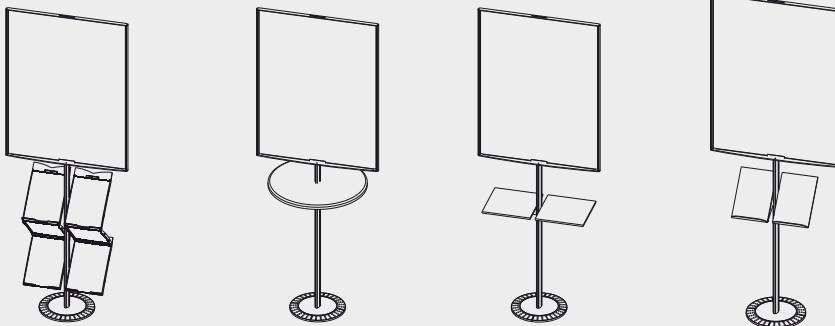

up-grade: possibili aggiunte come ripiani, tasche porta depliant o display per il proprio stopinfo personalizzato. contattateci pure per consigli e suggerimenti.

up-grade: mögliche add-on produkte wie ablagen, prospektaschen oder info-display, für ihren persönlichen stopinfo. fragen sie uns, wir beraten sie gerne.

up-grade: possible add-on products like shelves, brochure pockets or displays for your personal stopinfo. please contact us for further details, it's our pleasure to assist you.



257

combinations

235

maginfo slim soistes

MADE IN EU design by KD



one side

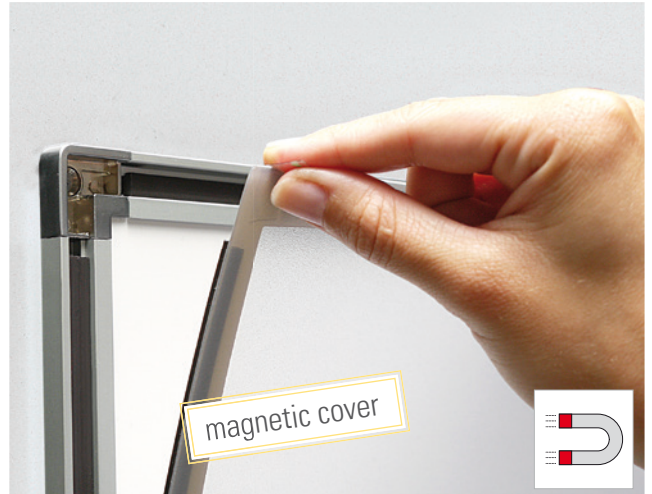

magnetic cover



IT maginfo slim è la perfetta combinazione di magnedoor slim, cornice magnetica facilmente intercambiabile, e una struttura stabile e robusta in alluminio anodizzato. il cambio delle informazioni è pratico, facile e veloce: basta sollevare il foglio protettivo flessibile in policarbonato anti riflesso. maginfo slim può inoltre essere completato con un ripiano per 2 A4 in acrilico satinato.

DE maginfo slim kombiniert den schnellwechselrahmen magnedoor slim und eine stabile soistes struktur zum freistehenden bodendisplay. der informationswechsel ist schnell und unkompliziert: einfach die flexible coverfolie aus nicht reflektierendem polycarbonat abnehmen. optional kann ihr maginfo slim mit ein ablage für 2 A4 aus satiniertem acrylglas perfekt ergänzt werden.

EN maginfo slim combines the magnedoor slim frame with a stable soistes structure to create a freestanding floor display. for information exchange simply swing open the flexible front cover made of non reflective polycarbonate. you can upgrade your maginfo slim with a transparent acrylic tray for two A4 formats.



ripiano per 2 depliant in A4 verticale, acrilico satinato, inclinabile orizzontalmente e posizionabile liberamente su tutta la lunghezza del profilo.

ablage für 2 A4 aus satiniertem acrylglas, horiz. neigbar und stufenlos höhenverstellbar made of silver anodized aluminium

satin acrylic tray for 2 A4 sized literature, these trays are adjustable horizontally and in height.

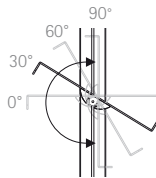

information

cornice magnetica maginfo slim, alluminio anodizzato color argento, base con rivestimento di protezione in abs.

schnellwechselrahmen maginfo slim, silber eloxiertes aluminium, abs- trittschutzring.

quick exchange frame maginfo slim, silver anodized aluminium, abs-step on protection ring.

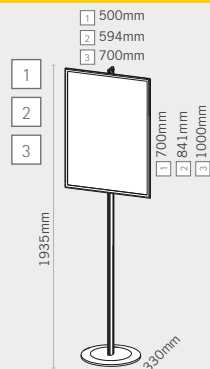

maginfo slim soistes

1	SOMS700500	maginfo slim 700x500mm, 1pc	
2	SOMSA1	maginfo slim A1, 1pc	
3	SOMS1000700	maginfo slim 1000x700mm, 1pc	
4	SOTR2A4TR	tray 2 A4 V, 1pc	



1
maginfo slim 700x500mm



1 + 4
maginfo slim 700x500mm + tray 2A4 V
price for this combination

order brochure shelf extra | tray 2 A4 V not included



rondo

MADE IN EU design by KD

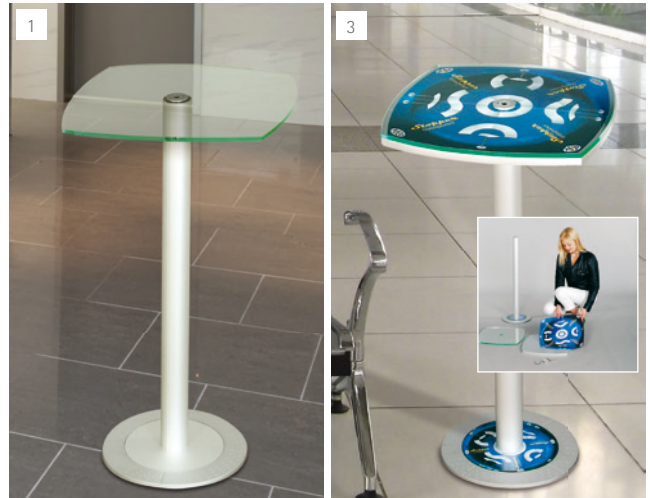

2 set rondo table top mdf

IT grazie a rondo, dalla serie stopper, potete arredare i vostri ambienti con tavolini e punti di appoggio eleganti e funzionali. base con rivestimento di protezione in abs cromato; tavolini disponibili in vetro e in mdf verniciato color argento: usati in combinazione l'uno con l'altro, i due tavolini vi danno la possibilità di sfruttare una superficie personalizzabile. in aggiunta, potete rendere personalizzabile anche la base, grazie all'inserto centrale in vetro da usare in combinazione con il rivestimento laterale di protezione. rondo è semplicissimo da montare, rendendosi così insostituibile per fiere, eventi, negozi, showroom e uffici.

DE mit den rondo tischen aus dem stopper programm mehrwert sichern: basis mit mattverchromten trittschutzring aus abs. die tischplatten sind in glas oder silberlackiertem mdf erhältlich. in der kombination beider ausführungen miteinander erhalten sie eine schnell personalisierbare werbefläche. dazu passt die ebenfalls schnell mit printinlay gestaltete basis mit glaseinsatz. rondo ist schnell aufgestellt und empfiehlt sich für messen, events, shop, showroom und office.

EN gain publicity space with the rondo tables: base with a satin chrome-plated step-on protection made of abs. the table tops are available in glass or silver-varnished mdf. with the combination of both table tops you get a quick customizable extra marketing space. in this version the base can also be customized with a print inlay in no time at all. rondo sets up quickly and is your perfect choice for fairs, events, shops, offices and showrooms.

information

base con rivestimento di protezione in abs cromato; tavolini disponibili in vetro e in mdf verniciato color argento

basis mit mattverchromten trittschutzring aus abs. die tischplatten sind in glas oder silberlackiertem mdf.

base with a satin chrome-plated step-on protection made of abs. the table tops are available in glass or silver-varnished mdf.

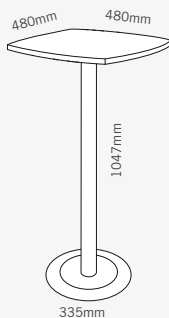

rondo

1	STCRONDOVE*	set rondo table top glass, 1pc
2	STCRNDOMDF*	set rondo table top mdf, 1pc
3	STCRONDOVEMDF*	set rondo table top glass, 1pc

* fino ad esaurimento scorte | solange vorrat reicht | while stock last





cubo

MADE IN EU design by KD



conveniente per giochi a premi, elezioni, raccolta contatti su fiere, questionario per clienti o altre persone

praktisch für preisausschreiben, wahlen, kontakte auf messen sammeln, kunden- oder personenbefragung.

perfekt for competitions, elections, collection of business contacts on fairs, surveys of customers or in general

stopper

1
cubo

IT volete organizzare un gioco a premi, una votazione oppure semplicemente volete raccogliere i biglietti da visita dei vostri visitatori? la soluzione per tutto questo è cubo. il cubo di 250mm in acrilico satinato, con fessura nella parte superiore e porta richiudibile, è autoportante, e sorretto dalla stabile base con rivestimento di protezione in abs e dal tubo in alluminio anodizzato color argento satinato. nella confezione sono incluse 2 chiavi.

DE sie haben ein gewinnspiel, eine befragung, eine wahl zu organisieren oder wollen einfach die visitenkarten der besucher sammeln? alles kein problem mit cubo. der 250mm würfel aus satiniertem acrylglas, mit einwurf und verschliessbarer tür ist freistehend auf einer stabilen basis mit abs-trittschutzing und silber eloxiertem aluminiumpfosten montiert. zwei schlüssel sind im lieferumfang enthalten.

EN do you want to play a game with prizes, organise a vote or simply collect business cards from your visitors? the solution to all of this is cubo. the satin acrylic 250mm cube with a slot in the top and a lockable door. it is free standing with a stable base protected by abs, the post is in silver coloured anodised aluminium. 2 keys are included.

information

base con rivestimento di protezione in abs cromato; tavolini disponibili in vetro e in mdf verniciato color argento

basis mit mattverchromten trittschutzing aus abs. die tischplatten sind in glas oder silberlackiertem mdf.

base with a satin chrome-plated step-on protection made of abs. the table tops are available in glass or silver-varnished mdf.

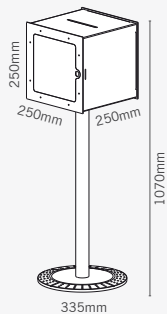

rispetto della privacy chiusura a chiave.

manipulationssicher verschliessbar.

privacy respected and tamper-proof

cubo



1 CUBO250

cubo, 1pc