

SIGN

segnaletica e informazione

IT porta-informazioni per tutti i gusti: in acrilico, in vetro, cartacei, arrotondati o squadri, con o senza fori, da personalizzare o dove inserire direttamente le informazioni, set completi con distanziali, in tutti i formati piú comuni.









beschilderung und information









DE informationsträger in allen variationen: acryl, glas oder papier, gerundet oder rechteckig, mit und ohne löcher, für einschub oder beschriftung, komplette sets mit wandhalter, in allen gängigen grössen.

signage and information

EN information carriers of all kinds: acrylic, glass or paper, rounded or square, with and without holes, with insert for information or for labeling, complete sets with spacers and signs, in all common sizes.



							
signcode eXtern	signcode	signcode colors	signcode braille	signcode in-out	signshine	securecode	fireman
278-280	281-285	286-289	290	291	292-293	294	295

							
secure drop	metal drop	safepix wall	safepix glass	safepix flag	fisso flag	printosign	badgepoint printbadge
296	297	298	299	300-301	302-303	304-305	306

							
linfor	smartquick	pixquick pixquick silver	pixquick wall	pixquick flag	pixquick suspension	pixquick floor	infoglass & steel
307	308-309	310-311	312	313	314	315	316

							
set infoquick & midi	clamper	luxboard	clipper	clipinfo	lumo clipper	lumo	lumo twist
317	318	319	320	321	322-323	324-325	326-327

							
magnedoor	magnedoor slim	mago magnedoor	cartbox	maxilibro	framframe floor	digipresso	pylo pylo poster
328	329	330	331	332-333	334	335	336

			
pylo outdoor	ipoint	signwalk passboard	maxiboard
337	338-339	340	341

**NEW
PRODUCT**



signcode eXtern

 MADE IN EU design by KD

IT una perfetto sistema di segnaletica si vede in primo luogo da come le indicazioni collocate all'esterno accolgono i visitatori. grazie alla nostra nuova gamma di signcode extern bifacciale e flessibile è possibile combinare 45 formati diversi in modo modulare. le indicazioni bifacciali possono essere personalizzate tramite stampa diretta o plastificazione. le indicazioni vengono inserite nel prodotto e sono intercambiabili in qualsiasi momento. i materiali sono di alta qualità e adatti all'uso esterno. grazie alle nostre speciali basi, signcode extern avrà un grande successo anche negli spazi interni.

DE zu einem perfekten wegleitsystem gehört bereits der empfang im aussenbereich. mit unserem doppelseitigem flexiblen signcode eXtern programm können sie 45 verschiedene masse kombinieren und modular gestalten. die doppelseitigen tafeln können mit direktdruck oder laminat personalisiert werden. die tafeln werden eingeschoben und sind jederzeit austauschbar. alle materialien sind hochwertig und für den aussenbereich geeignet. aber auch im innenbereich macht signcode eXtern mit unseren speziellen basen eine gute figur.

EN perfect signage welcomes visitors already to the outdoor area. with our double sided flexible signcode eXtern program you can combine 45 different sign sizes and design them in a modular way. the double sided signs can be customized with direct print or lamination. the signs are simply inserted and can be exchanged at anytime. all materials used are high grade and perfect for outdoor use. but also for indoors, you can use signcode eXtern with our special bases.

ideas

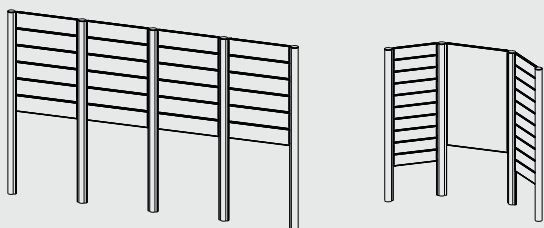

information

alluminio anodizzato color argento, con tappi superiori in argento realizzati in pressofusione, A monolaterale per delimitare zone esterne, B bilaterale per posizionamento centrale

silber eloxiertes aluminium, kappen aus versilbertem metall-druckguss, A einseitig für aussenbegrenzung, B zweiseitig für mittige position

silver anodized aluminium, caps made of silver plated die-cast metal, A single sided for outside posts, B double sided for center posts

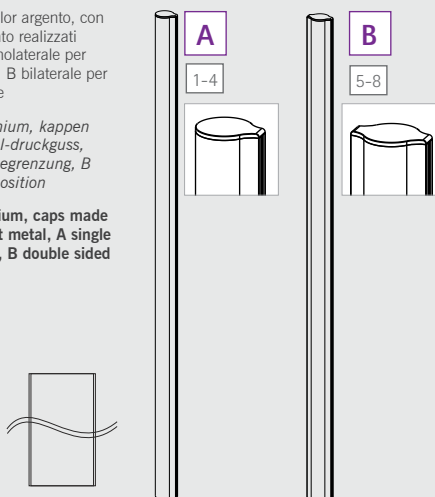

bussolle da terra da avvitare su ferro zincato

bodenhülse zum festschrauben auf verzinktem eisen

ground sleeve to be screwed on, made of zincated iron

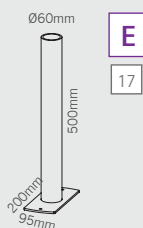

bussolle da terra per calcestruzzo o fondamenta in cemento

bodenhülse für beton oder zement fundamente

ground sleeve for concrete installation

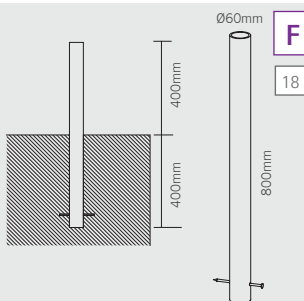

targhe bifacciali con cornici in alluminio anodizzato color argento, angoli realizzati in metallo pressofuso satinato color argento, lastra in alluminio con rivestimento bianco

doppelseitige tafeln mit silber eloxiertem aluminium profilrahmen, matt versilberten metall druckguss ecken, aluminium platten weiss beschichtet.

double sided signs with silver anodized aluminium frame, matt silver plated die-cast metal corner connectors, aluminium panels with white coating

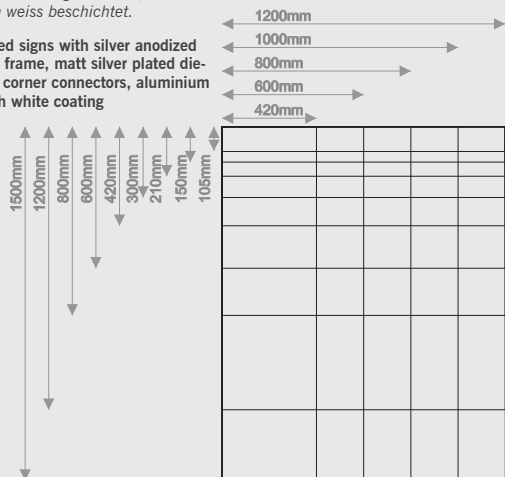

information

alluminio anodizzato color argento, tappi in metallo pressofuso color argento, D monolaterali per delimitare zone esterne, C bilaterali per posizionamento centrale. Solo per spazi interni

silber eloxiertes aluminium, kappen aus versilbertem metall-druckguss, D einseitig für aussenbegrenzung, C zweiseitig für mittige position. nur für innenbereich.

silver anodized aluminium, caps made of silver plated die-cast metal, D single sided for outside posts, C double sided for center posts. only for indoor use.

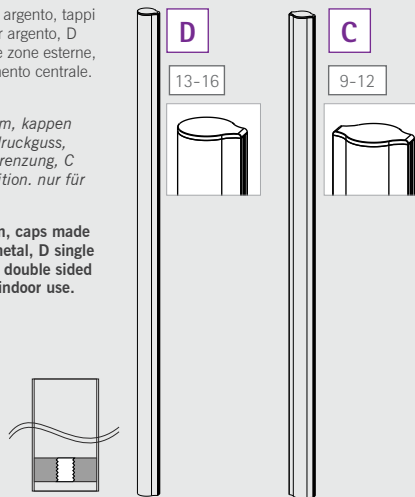

rivestimento di protezione in abs color grigio chiaro, con piastra di metallo, piede solo per l'uso in interno

lichtgraue abs abdeckung mit gewichtsplatte, standfuss nur für innenbereich.

light grey abs cover with weight plate, base only for indoors.

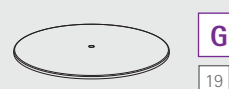

ulteriori informazioni pag. 216-217
mehr details s. more information p.

i moduli possono essere piegati fino a 140°

module können stufenlos bis 140° geneigt werden

modules can be positioned stagelessly up to 140°

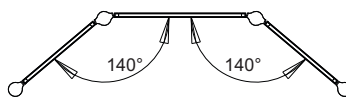

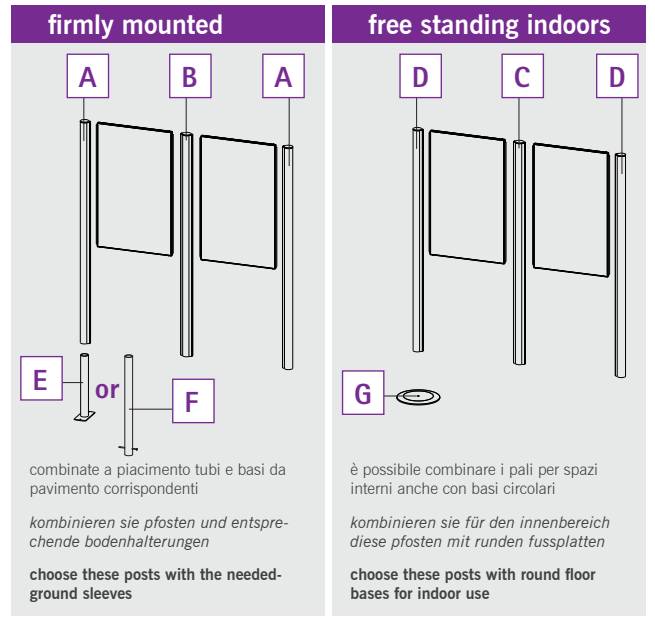

signcode eXtern 1)

1	SCXPAV1200	post A 1200mm, 2pcs
2	SCXPAV1500	post A 1500mm, 2pcs
3	SCXPAV1800	post A 1800mm, 2pcs
4	SCXPAV2000	post A 2000mm, 2pcs
5	SCXPMV1200	post B 1200mm 1pc
6	SCXPMV1500	post B 1500mm 1pc
7	SCXPMV1800	post B 1800mm 1pc
8	SCXPMV2000	post B 2000mm 1pc
9	SCXPMM1200	post C 1200mm 1pc
10	SCXPMM1500	post C 1500mm 1pc
11	SCXPMM1800	post C 1800mm 1pc
12	SCXPMM2000	post C 2000mm 1pc
13	SCXPAM1200	post D 1200mm 2pcs
14	SCXPAM1500	post D 1500mm 2pcs
15	SCXPAM1800	post D 1800mm 2pcs
16	SCXPAM2000	post D 2000mm 2pcs
17	SCXFLOOR	ground sleeve E, 1pc
18	SCXGROUND	ground sleeve F, 1pc
19	STE330LG	base for indoors, 1pc
20	SCX105420	signcode extern 105x420mm, 1pc
21	SCX105600	signcode extern 105x600mm, 1pc
22	SCX105800	signcode extern 105x800mm, 1pc
23	SCX1051000	signcode extern 105x1000mm, 1pc
24	SCX1051200	signcode extern 105x1200mm, 1pc
25	SCX150420	signcode extern 150x420mm, 1pc
26	SCX150600	signcode extern 150x600mm, 1pc
27	SCX150800	signcode extern 150x800mm, 1pc
28	SCX1501000	signcode extern 150x1000mm, 1pc
29	SCX1501200	signcode extern 150x1200mm, 1pc
30	SCX210420	signcode extern 210x420mm, 1pc
31	SCX210600	signcode extern 210x600mm, 1pc
32	SCX210800	signcode extern 210x800mm, 1pc

33	SCX2101000	signcode extern 210x1000mm, 1pc
34	SCX2101200	signcode extern 210x1200mm, 1pc
35	SCX300420	signcode extern 300x420mm, 1pc
36	SCX300600	signcode extern 300x600mm, 1pc
37	SCX300800	signcode extern 300x800mm, 1pc
38	SCX3001000	signcode extern 300x1000mm, 1pc
39	SCX3001200	signcode extern 300x1200mm, 1pc
40	SCX420420	signcode extern 420x420mm, 1pc
41	SCX420600	signcode extern 420x600mm, 1pc
42	SCX420800	signcode extern 420x800mm, 1pc
43	SCX4201000	signcode extern 420x1000mm, 1pc
44	SCX4201200	signcode extern 420x1200mm, 1pc
45	SCX600420	signcode extern 600x420mm, 1pc
46	SCX600600	signcode extern 600x600mm, 1pc
47	SCX600800	signcode extern 600x800mm, 1pc
48	SCX6001000	signcode extern 600x1000mm, 1pc
49	SCX6001200	signcode extern 600x1200mm, 1pc
50	SCX800420	signcode extern 800x420mm, 1pc
51	SCX800600	signcode extern 800x600mm, 1pc
52	SCX800800	signcode extern 800x800mm, 1pc
53	SCX8001000	signcode extern 800x1000mm, 1pc
54	SCX8001200	signcode extern 800x1200mm, 1pc
55	SCX1200420	signcode extern 1200x420mm, 1pc
56	SCX1200600	signcode extern 1200x600mm, 1pc
57	SCX1200800	signcode extern 1200x800mm, 1pc
58	SCX12001000	signcode extern 1200x1000mm, 1pc
59	SCX12001200	signcode extern 1200x1200mm, 1pc
60	SCX1500420	signcode extern 1500x420mm, 1pc
61	SCX1500600	signcode extern 1500x600mm, 1pc
62	SCX1500800	signcode extern 1500x800mm, 1pc
63	SCX15001000	signcode extern 1500x1000mm, 1pc
64	SCX15001200	signcode extern 1500x1200mm, 1pc

1) in vendita da giugno 2013 | auslieferung ab juni 2013 | on sale from june 2013



signcode®

 MADE IN EU design by KD

IT signcode è il nuovo sistema modulare con chiusura a pressione realizzato con profili in alluminio anodizzato color argento. grazie al design e alla struttura il cambio delle informazioni è sempre pratico e veloce. signcode è disponibile in molti formati, è mono- e bifacciale ed ideale per applicazioni a parete e a soffitto. vi offriamo signcode in due versioni: con un pannello di alluminio verniciato color bianco o con un protettivo trasparente in PS. la cornice smussata con spessore di 4mm e gli angoli in metallo pressofuso color argento rendono signcode discreto e tuttavia elegante. per un colpo d'occhio che non passa inosservato.

DE signcode das vielfältige stecksystem mit federverschluss aus silber eloxiertem aluminimprofilen. dank des cleveren designs ist der info-austausch jederzeit schnell und einfach. signcode ist erhältlich in vielen grössen, ein- oder doppelseitig als wand-, decken- oder fahnnenschild. wir bieten signcode in zwei versionen: mit weiss beschichtetem aluminiumpaneel oder einer transparenten ps-abdeckung. ein gephaseter, diskreter rahmen von 4mm und die versilberten metalldruckguss ecken machen ihr signcode zu einem variablen und eleganten hingucker.

EN signcode is the variant connector system with clip locking made of silver anodized aluminium profiles. thanks to the clever design the exchange of information is quick and easy at anytime. signcode is available in many sizes, single and double sided, as wall, flag or ceiling sign. we offer signcode in two different versions: with a white coated aluminium panel or a transparent PS-cover. a beveled and discrete 4mm frame and the silver plated die-cast metal edge connectors make your signcode a variable yet an elegant eye-catcher.

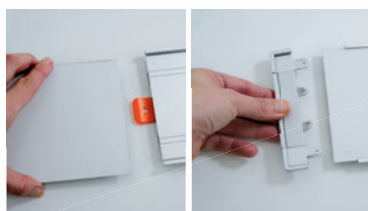

inserire nella cornice il pannello in alluminio o in PS trasparente e chiudere il sistema lateralmente. per aprire la cornice basta premere sul gancio di sicurezza con una tessera plastificata tipo carta di credito.

paneel aus alu oder transparentem PS einschieben und seitlichen verschluss einklicken. zum öffnen einfach die sicherung mit einer scheckkarte lösen.



insert panel made of aluminium or transparent PS and click in the lateral side part. for opening simply loosen the latch with a slim card.

signCODE



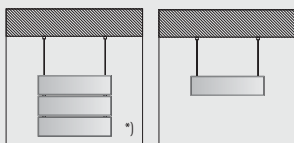

information

suspension

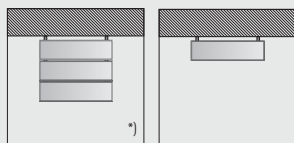

ceiling



flag

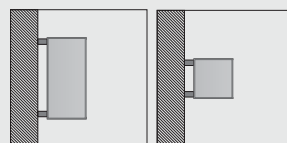

wall



*) esempio di utilizzo, su richiesta | anwendungsbeispiel auf anfrage | example of use, on request



pannello in alluminio, spessore 1,2 mm, di colore bianco RAL9016, per decorazione con pellicole adesive o per stampa diretta, per esempio con il sistema printolux

aluminium panel 1,2mm beschichtet in RAL9016 weiss, für aufkaschieren oder direktdruck, z.b. mit printolux system

aluminium panel 1,2mm coated in RAL9016 white, for laminating or direct printing, e.g. with the printolux system

protettivo trasparente in PS antiriflesso, spessore 1,2 mm, per stampa su carta; sul retro può anche essere decorato con pellicole adesive o stampato direttamente

abdeckung aus 1,2mm starkem nicht reflektierendem PS, für papierdruck, kann aber auch rückseitig aufkaschiert oder direkt bedruckt werden.

cover made of 1,2mm thick non reflective PS, for paper prints, it can also be laminated or printed on the rear side.

grazie alla modularità del sistema sono disponibili molti formati per la parete o il soffitto; mono- e bifacciale; chiusura di sicurezza a pressione, per un cambio informazioni veloce ma a prova di manomissioni

dank stecksystem viele grössen für wand, decke und fahne, ein- und zweiseitig mit cleverem federverschluss, für schnellwechsel und manipulationschutz

thanks to the connector system many different sizes for wall and ceiling, single and double sided, with clever clip lock, quick exchange, tamper proof.





signcode® paper MADE IN EU design by KD

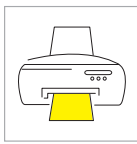

information

A4

148m

148m

1

IT pratico: inserto cartaceo prefustellato per la personalizzazione del nostro sistema signcode. carta bianco opaco 160g/m in formato A4, prefustellato, inserti centrali 148x148mm.

DE praktisch: vorgestanzte einleger für unsere signcode systeme zum selber drucken: 160g/m papier weissmatt in A4 format mit mittig vorgestanztem einleger 148x148mm.

EN convenient: preprinted paper inlay for our signcode systems for customizing with print: 160g/m paper white matt in A4 format with a center preprinted inlay of 148x148mm.



signcode paper

1 FSP148148 signcode paper, 148x148mm, 20pcs

sign

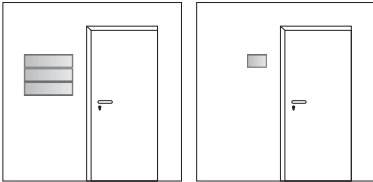

signcode wall

targa a parete monofacciale, materiale per il montaggio incluso

einseitiges wandschild, montage material inkl.

single side wall sign, mounting material incl.

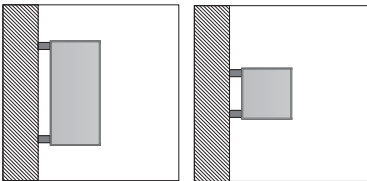

signcode flag

targa a bandiera bifacciale, materiale per il montaggio incluso; chiavi a brugola ACHI20 da ordinare separatamente!

doppelseitiges auslegerschild, inbus-schlüssel ACHI20 extra bestellen, montage material inklusiv

double sided flag sign, order extra hex key ACHI20, mounting material incl.



signcode wall

		mm		
1	FSOW65105AL	65x105	FSOW65105PS	
2	FSOW65148AL	65x148	FSOW65148PS	
3	FSOW65210AL	65x210	FSOW65210PS	
4	FSOW65297AL	65x297	FSOW65297PS	
5	FSOW65420AL	65x420	FSOW65420PS	
6	FSOW65600AL	65x600	FSOW65600PS	
7	FSOW105105AL	105x105	FSOW105105PS	
8	FSOW105148AL	105x148	FSOW105148PS	
9	FSOW105210AL	105x210	FSOW105210PS	
10	FSOW105297AL	105x297	FSOW105297PS	
11	FSOW105420AL	105x420	FSOW105420PS	
12	FSOW105600AL	105x600	FSOW105600PS	
13	FSOW105800AL	105x800	FSOW105800PS	
14	FSOW148148AL	148x148	FSOW148148PS	
15	FSOW148210AL	148x210	FSOW148210PS	
16	FSOW148297AL	148x297	FSOW148297PS	
17	FSOW148420AL	148x420	FSOW148420PS	
18	FSOW148600AL	148x600	FSOW148600PS	
19	FSOW148800AL	148x800	FSOW148800PS	
20	FSOW1481000AL	148x1000	FSOW1481000PS	
21	FSOW210210AL	210x210	FSOW210210PS	
22	FSOW210297AL	210x297	FSOW210297PS	
23	FSOW210420AL	210x420	FSOW210420PS	
24	FSOW210600AL	210x600	FSOW210600PS	
25	FSOW210800AL	210x800	FSOW210800PS	
26	FSOW2101000AL	210x1000	FSOW2101000PS	
27	FSOW2101200AL	210x1200	FSOW2101200PS	
28	FSOW297297AL	297x297	FSOW297297PS	
29	FSOW297420AL	297x420	FSOW297420PS	
30	FSOW297600AL	297x600	FSOW297600PS	
31	FSOW297800AL	297x800	FSOW297800PS	
32	FSOW2971000AL	297x1000	FSOW2971000PS	
33	FSOW2971200AL	297x1200	FSOW2971200PS	

signcode flag

		mm		
34	FSOF105105AL	105x105	FSOF105105PS	
35	FSOF148105AL	148x105	FSOF148105PS	
36	FSOF148148AL	148x148	FSOF148148PS	
37	FSOF210105AL	210x105	FSOF210105PS	
38	FSOF210148AL	210x148	FSOF210148PS	
39	FSOF210210AL	210x210	FSOF210210PS	
40	FSOF297105AL	297x105	FSOF297105PS	
41	FSOF297148AL	297x148	FSOF297148PS	
42	FSOF297210AL	210x297	FSOF297210PS	
43	FSOF297297AL	297x297	FSOF297297PS	



ordinare extra per flag e ceiling
inbus-schlüssel für flag und ceiling extra bestellen
 order key for flag and ceiling separately

44 ACHI20

allen key 1pc

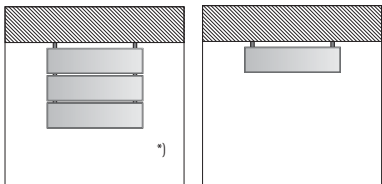

signcode ceiling

signcode ceiling: targa a soffitto bifacciale, materiale per il montaggio incluso; chiavi a brugola ACHI20 da ordinare separatamente! *) esempio di utilizzo, su richiesta

signcode ceiling: doppelseitiges auslegerschild, inbusschlüssel ACHI20 extra bestellen, montagematerial inkl. *) anwendungsbeispiel auf anfrage

signcode ceiling: double sided flag sign, order extra hex key ACHI20, mounting material incl. *) example of use, on request

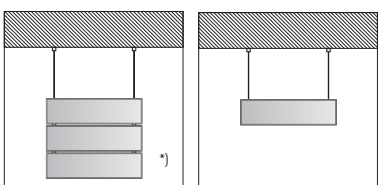
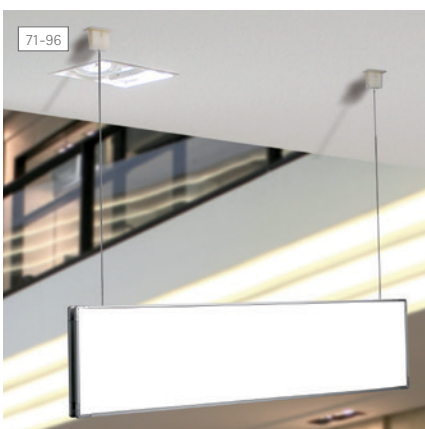

signcode suspension

signcode suspension: sistema bifacciale sospeso su cavi di acciaio, sospensione dal soffitto variabile fino ad un massimo di 1m di distanza, materiale per il montaggio incluso *) esempio di utilizzo, su richiesta

signcode suspension: doppelseitig für abhängung am seil, stufenlos verstellbar bis max. 1m deckenabstand, montagematerial inkl. *) anwendungsbeispiel auf anfrage

signcode suspension: double-side sign for ceiling suspension, steplessly adjustable up to max. 1m ceiling distance, order extra hex key ACHI20, mounting material incl. *) example of use, on request

signcode ceiling

		mm	
45	FSOC65210AL	65x210	FSOC65210PS
46	FSOC65297AL	65x297	FSOC65297PS
47	FSOC65420AL	65x420	FSOC65420PS
48	FSOC65600AL	65x600	FSOC65600PS
49	FSOC65800AL	65x800	FSOC65800PS
50	FSOC105210AL	105x210	FSOC105210PS
51	FSOC105297AL	105x297	FSOC105297PS
52	FSOC105420AL	105x420	FSOC105420PS
53	FSOC105600AL	105x600	FSOC105600PS
54	FSOC105800AL	105x800	FSOC105800PS
55	FSOC1051000AL	105x1000	FSOC1051000PS
56	FSOC148297AL	148x297	FSOC148297PS
57	FSOC148420AL	148x420	FSOC148420PS
58	FSOC148600AL	148x600	FSOC148600PS
59	FSOC148800AL	148x800	FSOC148800PS
60	FSOC1481000AL	148x1000	FSOC1481000PS
61	FSOC1481200AL	148x1200	FSOC1481200PS
62	FSOC210420AL	210x420	FSOC210420PS
63	FSOC210600AL	210x600	FSOC210600PS
64	FSOC210800AL	210x800	FSOC210800PS
65	FSOC2101000AL	210x1000	FSOC2101000PS
66	FSOC2101200AL	210x1200	FSOC2101200PS
67	FSOC297600AL	297x600	FSOC297600PS
68	FSOC297800AL	297x800	FSOC297800PS
69	FSOC2971000AL	297x1000	FSOC2971000PS
70	FSOC2971200AL	297x1200	FSOC2971200PS

signcode suspension

		mm	
71	FSOS65210AL	65x210	FSOS65210PS
72	FSOS65297AL	65x297	FSOS65297PS
73	FSOS65420AL	65x420	FSOS65420PS
74	FSOS65600AL	65x600	FSOS65600PS
75	FSOS65800AL	65x800	FSOS65800PS
76	FSOS105210AL	105x210	FSOS105210PS
77	FSOS105297AL	105x297	FSOS105297PS
78	FSOS105420AL	105x420	FSOS105420PS
79	FSOS105600AL	105x600	FSOS105600PS
80	FSOS105800AL	105x800	FSOS105800PS
81	FSOS1051000AL	105x1000	FSOS1051000PS
82	FSOS148297AL	148x297	FSOS148297PS
83	FSOS148420AL	148x420	FSOS148420PS
84	FSOS148600AL	148x600	FSOS148600PS
85	FSOS148800AL	148x800	FSOS148800PS
86	FSOS1481000AL	148x1000	FSOS1481000PS
87	FSOS1481200AL	148x1200	FSOS1481200PS
88	FSOS210420AL	210x420	FSOS210420PS
89	FSOS210600AL	210x600	FSOS210600PS
90	FSOS210800AL	210x800	FSOS210800PS
91	FSOS2101000AL	210x1000	FSOS2101000PS
92	FSOS2101200AL	210x1200	FSOS2101200PS
93	FSOS297600AL	297x600	FSOS297600PS
94	FSOS297800AL	297x800	FSOS297800PS
95	FSOS2971000AL	297x1000	FSOS2971000PS
96	FSOS2971200AL	297x1200	FSOS2971200PS

**NEW
PRODUCT**

signcode® colors

MADE IN EU design by KD

IT L'innovativa segnaletica signcode colors offre un sistema direzionale a colori integrato nella cornice, adatti per indicatori a bandiera verticali o orizzontali. oltre ai 4 colori standard della segnaletica di sicurezza, diamo la possibilità di scegliere fra ulteriori 4 colori. come già previsto dal sistema signcode, anche in questo caso sono disponibili le due versioni: con pannelli in alluminio per stampa diretta o con un protettivo trasparente in PS, che permette l'inserimento di stampe realizzate su supporto cartaceo. entrambi i sistemi sono a prova di manomissione, ma permettono comunque una semplice e veloce sostituzione d'informazioni evitando di smontare l'intera targa. signcode colors: segnaletica innovativa con un moderno sistema direzionale a colori.

DE das innovative beschilderungssystem signcode colors bietet exklusiv ein rahmenintegriertes farbleitsystem der vertikalen bzw. bei fahnschilder der horizontalen seiten. neben den 4 normfarben für die sicherheitsbeschilderung bieten wir ihnen weitere 4 farben zur auswahl. wie beim signcode system können sie direktbedruckte paneele verwenden oder die version mit papierinleger hinter transparenter abdeckung. beide systeme haben einen manipulationsschutz und können dennoch jederzeit ganz einfach ohne demontage gewechselt werden. signcode colors: innovative beschilderung mit modernem farbleitsystem.

EN the innovative signage system signcode colors offers you a directional system with colours integrated into the frame, adapt for both flag or horizontal use. over and above the 4 standard security colours, we give you the choice of a further 4 colours. just like the signcode signage you can use panels with direct print or paper print under transparent covers. both systems have a tamper-proof lock and you can change the information anytime easily without disassembling. signcode colors. innovate signage with modern color coding.



pannello in alluminio, spessore 1,2 mm, di colore bianco RAL9016, per decorazione con pellicole adesive o per stampa diretta, per esempio con il sistema printolux

aluminium paneel 1,2mm beschichtet in RAL9016 weiss, für aufkaschieren oder direktdruck, z.b. mit printolux system

aluminium panel 1,2mm coated in RAL9016 white, for laminating or direct printing, e.g. with the printolux system



protettivo trasparente in PS antiriflesso, spessore 1,2 mm, per stampa su carta; sul retro può anche essere decorato con pellicole adesive o stampato direttamente

abdeckung aus 1,2mm starkem nicht reflektierendem PS, für papierdruck, kann aber auch rückseitig aufkaschiert oder direkt bedruckt werden.

cover made of 1,2mm thick non reflective PS, for paper prints, it can also be laminated or printed on the rear side.

information

suspension

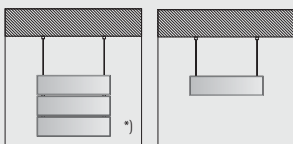

ceiling

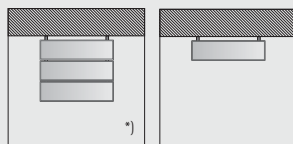

flag

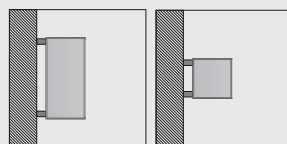

wall



*) esempio di utilizzo, su richiesta | anwendungsbeispiel auf anfrage | example of use, on request



inserire nella cornice il pannello in alluminio o in PS trasparente e chiudere il sistema lateralmente. per aprire la cornice basta premere sul gancio di sicurezza con una tessera plastificata tipo carta di credito.

paneel aus alu oder transparentem PS einschieben und seitlichen verschluss einklicken. zum öffnen einfach die sicherung mit einer scheckkarte lösen.

insert panel made of aluminium or transparent PS and click in the lateral part. for opening simply loosen the latch with a slim card.





*) inserire la sigla del colore nel campo bianco | farbcodes im weißen feld eintragen | insert the colour code in the blank space

scelta di colori | farbauswahl | choice of colours

AC	BR	BL	GR
RAL 7016	RAL 8019	RAL 5005	RAL 6024
RE	YE	LG	WH
RAL 3020	RAL 1023	RAL 7035	RAL 9016

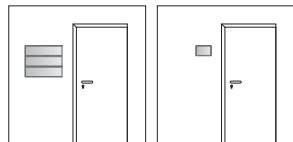
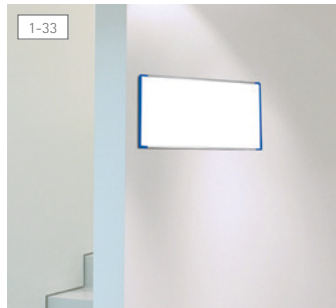

signcode wall

targa a parete monofacciale, materiale per il montaggio incluso
einseitiges wandschild, montage material inkl.
 single side wall sign, mounting material incl.

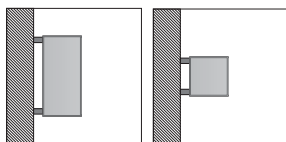

signcode flag

targa a bandiera bifacciale, lati orizzontali colorati
doppelseitiges auslegerschild, farbleitsystem horizontal
 double sided flag sign, horizontal sides coloured



signcode wall ¹⁾

		mm	
1	FSYW65105AL * <input type="text"/>	65x105	FSYW65105PS * <input type="text"/>
2	FSYW65148AL * <input type="text"/>	65x148	FSYW65148PS * <input type="text"/>
3	FSYW65210AL * <input type="text"/>	65x210	FSYW65210PS * <input type="text"/>
4	FSYW65297AL * <input type="text"/>	65x297	FSYW65297PS * <input type="text"/>
5	FSYW65420AL * <input type="text"/>	65x420	FSYW65420PS * <input type="text"/>
6	FSYW65600AL * <input type="text"/>	65x600	FSYW65600PS * <input type="text"/>
7	FSYW105105AL * <input type="text"/>	105x105	FSYW105105PS * <input type="text"/>
8	FSYW105148AL * <input type="text"/>	105x148	FSYW105148PS * <input type="text"/>
9	FSYW105210AL * <input type="text"/>	105x210	FSYW105210PS * <input type="text"/>
10	FSYW105297AL * <input type="text"/>	105x297	FSYW105297PS * <input type="text"/>
11	FSYW105420AL * <input type="text"/>	105x420	FSYW105420PS * <input type="text"/>
12	FSYW105600AL * <input type="text"/>	105x600	FSYW105600PS * <input type="text"/>
13	FSYW105800AL * <input type="text"/>	105x800	FSYW105800PS * <input type="text"/>
14	FSYW148148AL * <input type="text"/>	148x148	FSYW148148PS * <input type="text"/>
15	FSYW148210AL * <input type="text"/>	148x210	FSYW148210PS * <input type="text"/>
16	FSYW148297AL * <input type="text"/>	148x297	FSYW148297PS * <input type="text"/>
17	FSYW148420AL * <input type="text"/>	148x420	FSYW148420PS * <input type="text"/>
18	FSYW148600AL * <input type="text"/>	148x600	FSYW148600PS * <input type="text"/>
19	FSYW148800AL * <input type="text"/>	148x800	FSYW148800PS * <input type="text"/>
20	FSYW1481000AL * <input type="text"/>	148x1000	FSYW1481000PS * <input type="text"/>
21	FSYW210210AL * <input type="text"/>	210x210	FSYW210210PS * <input type="text"/>
22	FSYW210297AL * <input type="text"/>	210x297	FSYW210297PS * <input type="text"/>
23	FSYW210420AL * <input type="text"/>	210x420	FSYW210420PS * <input type="text"/>
24	FSYW210600AL * <input type="text"/>	210x600	FSYW210600PS * <input type="text"/>
25	FSYW210800AL * <input type="text"/>	210x800	FSYW210800PS * <input type="text"/>
26	FSYW2101000AL * <input type="text"/>	210x1000	FSYW2101000PS * <input type="text"/>
27	FSYW2101200AL * <input type="text"/>	210x1200	FSYW2101200PS * <input type="text"/>
28	FSYW297297AL * <input type="text"/>	297x297	FSYW297297PS * <input type="text"/>
29	FSYW297420AL * <input type="text"/>	297x420	FSYW297420PS * <input type="text"/>
30	FSYW297600AL * <input type="text"/>	297x600	FSYW297600PS * <input type="text"/>
31	FSYW297800AL * <input type="text"/>	297x800	FSYW297800PS * <input type="text"/>
32	FSYW2971000AL * <input type="text"/>	297x1000	FSYW2971000PS * <input type="text"/>
33	FSYW2971200AL * <input type="text"/>	297x1200	FSYW2971200PS * <input type="text"/>

1) in vendita da marzo 2013 | auslieferung ab märz 2013 | on sale from march 2013

signcode flag ¹⁾

		mm	
34	FSYF105105AL * <input type="text"/>	105x105	FSYF105105PS * <input type="text"/>
35	FSYF148105AL * <input type="text"/>	148x105	FSYF148105PS * <input type="text"/>
36	FSYF148148AL * <input type="text"/>	148x148	FSYF148148PS * <input type="text"/>
37	FSYF210105AL * <input type="text"/>	210x105	FSYF210105PS * <input type="text"/>
38	FSYF210148AL * <input type="text"/>	210x148	FSYF210148PS * <input type="text"/>
39	FSYF210210AL * <input type="text"/>	210x210	FSYF210210PS * <input type="text"/>
40	FSYF297105AL * <input type="text"/>	297x105	FSYF297105PS * <input type="text"/>
41	FSYF297148AL * <input type="text"/>	297x148	FSYF297148PS * <input type="text"/>
42	FSYF297210AL * <input type="text"/>	297x210	FSYF297210PS * <input type="text"/>
43	FSYF297297AL * <input type="text"/>	297x297	FSYF297297PS * <input type="text"/>

1) in vendita da marzo 2013 | auslieferung ab märz 2013 | on sale from march 2013



ordinare extra per flag e ceiling
inbus-schlüssel für flag und ceiling extra bestellen
 order key for flag and ceiling separately

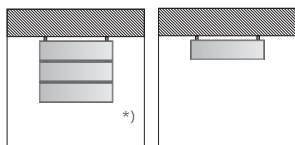
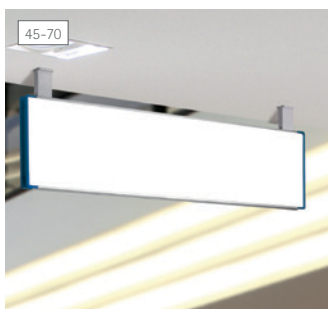

signcode ceiling

signcode ceiling: targa a soffitto bifacciale, materiale per il montaggio incluso; chiavi a brugola ACHI20 da ordinare separatamente! *) esempio di utilizzo, su richiesta

signcode ceiling: doppelseitiges auslegerschild, inbus-schlüssel ACHI20 extra bestellen, montagematerial inkl. *) anwendungsbeispiel auf anfrage

signcode ceiling: double sided flag sign, order extra hex key ACHI20, mounting material incl. *) example of use, on request

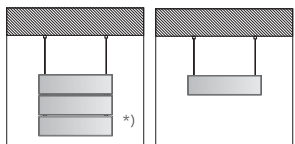

signcode suspension

signcode suspension: sistema bifacciale sospeso su cavi di acciaio, sospensione dal soffitto variabile fino ad un massimo di 1m di distanza, materiale per il montaggio incluso *) esempio di utilizzo, su richiesta

signcode suspension: doppelseitig für abhängung am seil, stufenlos verstellbar bis max. 1m deckenabstand, montagematerial inkl. *) anwendungsbeispiel auf anfrage

signcode suspension: double-side sign for ceiling suspension, steplessly adjustable up to max. 1m ceiling distance, order extra hex key ACHI20, mounting material incl. *) example of use, on request

signcode ceiling ¹⁾

		mm	
45	FSYC65210AL	65x210	FSYC65210PS
46	FSYC65297AL	65x297	FSYC65297PS
47	FSYC65420AL	65x420	FSYC65420PS
48	FSYC65600AL	65x600	FSYC65600PS
49	FSYC65800AL	65x800	FSYC65800PS
50	FSYC105210AL	105x210	FSYC105210PS
51	FSYC105297AL	105x297	FSYC105297PS
52	FSYC105420AL	105x420	FSYC105420PS
53	FSYC105600AL	105x600	FSYC105600PS
54	FSYC105800AL	105x800	FSYC105800PS
55	FSYC1051000AL	105x1000	FSYC1051000PS
56	FSYC148297AL	148x297	FSYC148297PS
57	FSYC148420AL	148x420	FSYC148420PS
58	FSYC148600AL	148x600	FSYC148600PS
59	FSYC148800AL	148x800	FSYC148800PS
60	FSYC1481000AL	148x1000	FSYC1481000PS
61	FSYC1481200AL	148x1200	FSYC1481200PS
62	FSYC210420AL	210x420	FSYC210420PS
63	FSYC210600AL	210x600	FSYC210600PS
64	FSYC210800AL	210x800	FSYC210800PS
65	FSYC2101000AL	210x1000	FSYC2101000PS
66	FSYC2101200AL	210x1200	FSYC2101200PS
67	FSYC297600AL	297x600	FSYC297600PS
68	FSYC297800AL	297x800	FSYC297800PS
69	FSYC2971000AL	297x1000	FSYC2971000PS
70	FSYC2971200AL	297x1200	FSYC2971200PS

1) in vendita da marzo 2013 | auslieferung ab märz 2013 | on sale from march 2013

signcode suspension ¹⁾

		mm	
71	FSYS65210AL	65x210	FSYS65210PS
72	FSYS65297AL	65x297	FSYS65297PS
73	FSYS65420AL	65x420	FSYS65420PS
74	FSYS65600AL	65x600	FSYS65600PS
75	FSYS65800AL	65x800	FSYS65800PS
76	FSYS105210AL	105x210	FSYS105210PS
77	FSYS105297AL	105x297	FSYS105297PS
78	FSYS105420AL	105x420	FSYS105420PS
79	FSYS105600AL	105x600	FSYS105600PS
80	FSYS105800AL	105x800	FSYS105800PS
81	FSYS1051000AL	105x1000	FSYS1051000PS
82	FSYS148297AL	148x297	FSYS148297PS
83	FSYS148420AL	148x420	FSYS148420PS
84	FSYS148600AL	148x600	FSYS148600PS
85	FSYS148800AL	148x800	FSYS148800PS
86	FSYS1481000AL	148x1000	FSYS1481000PS
87	FSYS1481200AL	148x1200	FSYS1481200PS
88	FSYS210420AL	210x420	FSYS210420PS
89	FSYS210600AL	210x600	FSYS210600PS
90	FSYS210800AL	210x800	FSYS210800PS
91	FSYS2101000AL	210x1000	FSYS2101000PS
92	FSYS2101200AL	210x1200	FSYS2101200PS
93	FSYS297600AL	297x600	FSYS297600PS
94	FSYS297800AL	297x800	FSYS297800PS
95	FSYS2971000AL	297x1000	FSYS2971000PS
96	FSYS2971200AL	297x1200	FSYS2971200PS

1) in vendita da marzo 2013 | auslieferung ab märz 2013 | on sale from march 2013



signcode® braille

 MADE IN EU design by KD

IT offriamo anche una segnaletica in braille con simboli a rilievo, integrata nei nostri pannelli signcode e signcode color. per lo sfondo e per i simboli in rilievo mettiamo a disposizione vari colori. ogni realizzazione prevede una lavorazione su misura ed è quindi realizzato a richiesta in base alle vostre esigenze e richieste. per ulteriori informazioni su questo prodotto esclusivo, non esitate a contattarci.

DE beschilderung mit braille-schrift und tastbaren symbolen verwirklichen wir gerne für ihr projekt. wir verwenden dazu unsere systeme signcode oder signcode color als grundlage. für hintergrund sowie für die haptischen bereiche bieten wir diverse farben an. jedes schild ist eine einzelfertigung und wird genau nach ihrer vorgabe gefertigt. fragen sie uns, wir beraten sie gerne persönlich.

EN we realize also signage with braille and palpable symbols for your projects. we use our systems signcode or signcode colors as the base. for the background and the touchable areas we offer different colours. every sign is a custom made product and is made according to your design. please contact us for more details on this exclusive product.

prezzi su richiesta
preis auf anfrage
prices on demand

a b c d e f g h
1 2 3 4 5 6 7 8



signcode® in-out

 MADE IN EU design by KD

IT chiarezza a colpo d'occhio, informazione immediata, per sapere se una sala è occupata o no... tutto ciò è possibile grazie a signcode in-out! Spostate semplicemente la targhetta in rilievo con la mano e in un attimo sarà possibile informare tutti. signcode in-out è disponibile come standard in 3 lingue, ma possibile realizzare altri motivi. contattateci per ulteriori chiarimenti.

DE mit einem blick klarheit, ob ein raum frei ist oder belegt ist? signcode in-out macht's möglich! einfach das deckschild mit einem handgriff verschieben und schon weiss jeder bescheid. standardmässig bieten wir in-out in 3 sprachen, gerne realisieren wir auch andere motive. fragen sie uns, wir beraten sie gerne.

EN understand immediately if a room is free or not? signcode in-out can give you that information just with one slight move by the hand. the cover is easily switched and at once everybody is informed. we provide signcode in-out in 3 different languages but also customized images are possible. please contact us directly for further details.

**NEW
PRODUCT**



2
signcode in-out, german, 148x148mm



3 languages



signcode in-out

1	SI0IT148148AL	in-out, italian, 148x148mm, 1pc
2	SI0DE148148AL	in-out, german, 148x148mm, 1pc
3	SI0EN148148AL	in-out, english, 148x148mm, 1pc

information



alluminio anodizzato color argento, parti laterali color grigio chiaro realizzate in materiale sintetico, stampa diretta tramite il sistema printolux

silber eloxiertes aluminium, lichtgraue kunststoff seiten, direktdruck mit printolux system

silver anodized aluminium, light grey synthetic lateral parts, direct print with printolux system

**NEW
PRODUCT**



signshine®

C 3
ceiling 148x297mm

- ✓ - pannello fotoluminescente a lunga durata
- segnaletica di sicurezza in formato DIN 67510-1
- illumina uscite di sicurezza ed estintori al buio
- privo di sostanze nocive: privo di cadmio, non radioattivo
- prolungata luminescenza: autonomia superiore alle 12 ore
- luminescenza superiore allo standard normativo richiesto
- tonalità giallo chiaro: stampa indelebile
- luminescenza color verde-giallo

- ✓ - *nachleuchtendes photoluminiszierendes paneel*
- *gemäss DIN 67510-1 für sicherheitsbeschilderung*
- *zeigt fluchtwege und löschhilfen im dunkeln*
- *schadstoff-geprüft: cadmium frei, nicht radioaktiv*
- *nachhaltende leuchtkraft: über 12 stunden*
- *hohe leuchtstärke: vielfaches über normforderung*
- *geringer gelbstich – farbechte bedruckung*
- *leuchtet in gelbgrün*

- ✓ - **after glow, photo luminescent panel**
- **according to din 67510-1 for security signs**
- **shows escape routes and fire extinguishers in the dark**
- **tested for harmful substances: cadmium free, not radioactive**
- **long after glow: more than 12 hours**
- **high luminous intensity: much higher than standards demand**
- **light yellow appearance: color fast print**
- **glowing colour is yellow**

signshine®
DIN 67510

MADE IN EU design by KD

IT segnaletica di sicurezza luminescente di lunga durata unita all'intelligente sistema signcode: signshine offre una serigrafia realizzata su pvc fotoluminescente, ad alta e prolungata luminescenza. è possibile ricaricare signshine molto di frequente, è certificato per segnaletica interna e ha un'autonomia superiore alle 12 ore. offriamo misure standard per segnaletica a parete, a bandiera e a soffitto, o in alternativa anche solo i pannelli stampati con adesivo per l'applicazione. i lati colorati (le parti orizzontali rispettivamente le parti verticali per sistemi flag) sono in corrispondenza con il pittogramma scelto.

DE nachleuchtende sicherheitsbeschilderung mit dem intelligenten signcode system: signshine bietet siebdruck auf photoluminiszierendem pvc mit hoher leuchtdichte und langer nachleuchtzeit. signshine lädt sich beliebig oft auf, ist zertifiziert für raumbeschilderung und leuchtet über 12 stunden nach. wir bieten standard grössen als wand-, ausleger- oder deckenschild oder einfach nur als bedrucktes paneel zum aufkleben. bei der schildausführung ist der vertikale rahmen - bei fahnhenschild flag der horizontale - farblich auf das motiv abgestimmt.

EN after glow security signage with the intelligent signcode system: signshine offers silk screen prints on photo luminescent pvc panels with high luminance intensity and long after glow time. signshine has unlimited reenergizing capacity, it is certified for security signage and glows in the dark more than 12 hours. we offer standard sizes as wall, flag or ceiling signs as well as the printed panel with adhesive tape. the signs come with a vertical - flag signs with horizontal - frame colour matching the icon.

	signshine		DIN 67510-1	
	10min	60min	10min	60min
	mcd/m ²		mcd/m ²	
after glow intensity	70	9	20	3
after glow time	>800min			
colour appearance	light yellow			
after glow colour	yellow green			

ISO EN 7010

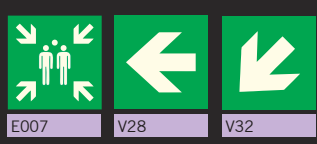
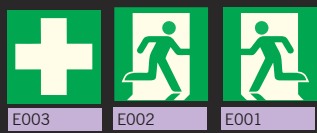
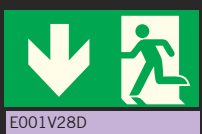
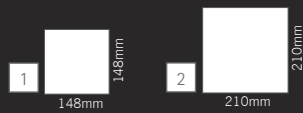

V28+V32 possono essere utilizzati solo in combinazione, a norma di legge

V28+V32 dürfen laut norm nur in kombination verwendet werden

use V28+32 only in combination with other symbols, standard: no single use

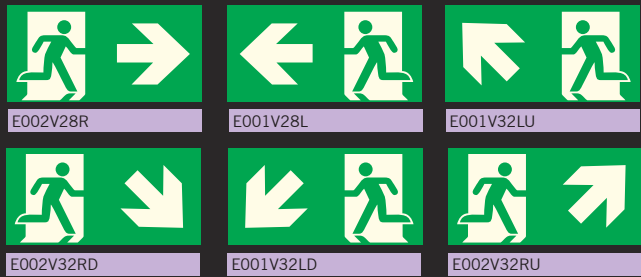

information

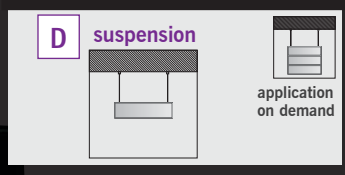
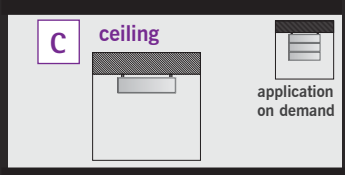
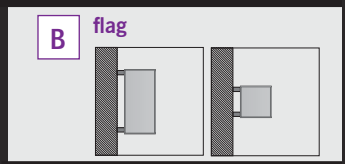
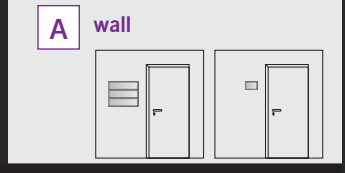

information

pannello rigido in PVC fotoluminescente, retro biadesivo, stampato con pittogrammi di sicurezza

nachleuchtende pvc hartplatte, rückseitig doppelkleber, bedruckt mit sicherheitsmotiv

photo luminescent pvc rigid plate, adhesive tape on rear side, printed with safety images

signshine complete¹⁾

1	SSHW148148	148x148mm	wall 148x148mm, 1pc
2	SSHW210210	210x210mm	wall 210x210mm, 1pc
3	SSHW148297	148x297mm	wall 148x297mm, 1pc
4	SSHW210420	210x420mm	wall 210x420mm, 1pc
1	SSHF148148	148x148mm	flag 148x148mm, 1pc
2	SSHF210210	210x210mm	flag 210x210mm, 1pc
3	SSHF148297	148x297mm	flag 148x297mm, 1pc
1	SSHC148148	148x148mm	ceiling 148x148mm, 1pc
2	SSHC210210	210x210mm	ceiling 210x210mm, 1pc
3	SSHC148297	148x297mm	ceiling 148x297mm, 1pc
4	SSHC210420	210x420mm	ceiling 210x420mm, 1pc
1	SSHS148148	148x148mm	suspension 148x148mm, 1pc
2	SSHS210210	210x210mm	suspension 210x210mm, 1pc
3	SSHS148297	148x297mm	suspension 148x297mm, 1pc
4	SSHS210420	210x420mm	suspension 210x420mm, 1pc

¹⁾ in vendita da marzo 2013 | auslieferung ab märz 2013 | on sale from march 2013

signshine plate

1	SSHP148148	148x148mm	rigid panel 148x148mm, 1pc
2	SSHP210210	210x210mm	rigid panel 210x210mm, 1pc
3	SSHP148210	148x210mm	rigid panel 148x210mm, 1pc
4	SSHP210420	210x420mm	rigid panel 210x420mm, 1pc

signshine® panel



adhesive tape

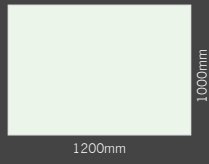

pannello fotoluminescente ad alta autonomia da personalizzare tramite stampa serigrafica o inchiostro solvente; spessore 1,2mm
pannello rigido biadesivo in pvc

nachleuchtendes paneel zum selbst bedrucken mit siebdruck oder solvent ink. 1,2mm stark, mit doppelklebefolie, pvc hartplatte

photo luminescent panel can be printed with silk screen or solvent ink. 1,2mm thick, with double adhesive tape, pvc rigid panel

signshine® panel

1	SSH12001000	1200x1000mm
---	-------------	-------------



new standard ISO EN 7010

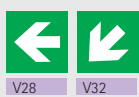

V28+V32 possono essere utilizzati solo in combinazione, a norma di legge

V28+V32 dürfen laut norm nur in kombination verwendet werden

use V28+32 only in combination with other symbols, standard: no single use

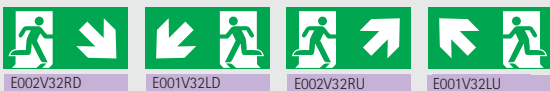

information

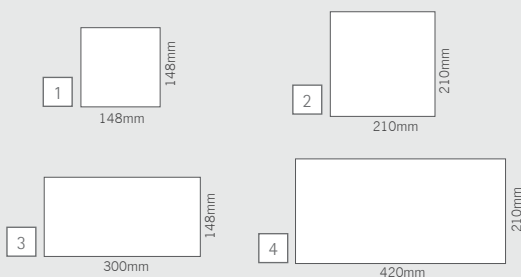

signcode® secure

MADE IN EU design by KD

IT segnaletica a parete completa di pittogrammi e angoli e cornici verticali del colore corrispondente al pittogramma stesso per uso interno: signcode secure vi offre una segnaletica completa. disponibile in quattro formati standard con pittogrammi realizzati in serigrafia per segnaletica di evacuazione e direzione. i pittogrammi possono essere sostituiti in modo facile e veloce grazie all'intelligente sistema signcode.

DE fertige wandbeschilderung mit sicherheitsmotiven und passender rahmenfarbkennung für den innenbereich: signcode secure hat alles schon fix fertig für sie. erhältlich in vier standardgrößen und besiedruckt mit den gängigsten motiven für fluchtweg- und sicherheitsleitsysteme. die motive lassen sich dank des cleveren signcode systems jederzeit ganz einfach austauschen.

EN ready made wall signage with security images and matching frame colours for indoor use: signcode secure has everything already for you. available in four standard sizes with silk screen prints of the most common icons for escape routes and security signage. the images can be exchanged anytime easily thanks to the clever signcode design.

signcode secure¹⁾

1	SCD148148	secure code, 148x148mm, 1pc
2	SCD210210	secure code, 210x210mm, 1pc
3	SCD148300	secure code, 148x300mm, 1pc
4	SCD210420	securecode, 210x420mm, 1pc

¹⁾ In vendita da marzo 2013 | auslieferung ab märz 2013 | on sale from march 2013



fireman

MADE IN EU design by KD

IT fireman è il segnalatore autoportante per estintori, ideale laddove non sia possibile allestire un tipo di segnaletica permanente: per esempio in ambienti vincolati alla tutela dei monumenti o per eventi itineranti di ogni tipo. È sufficiente posizionare l'espositore fireman e appoggiare l'estintore sulla base. In caso di emergenza l'estintore è facilmente identificabile e sempre pronto all'uso.

DE fireman die mobile beschilderung ist genau das richtige, wenn eine fixe sicherheitsbeschilderung nicht erwünscht oder möglich ist, wie z.b. in denkmalgeschützten gebäuden und bei events aller art. fireman einfach aufstellen und den löscher auf die basis stellen. im ernstfall ist der löscher gut zu identifizieren und schnell bei der hand

EN fireman, the mobile signage for fire extinguishers, is perfect where fixed mounted signage is undesired such as heritage protected buildings or events of any kind. simply position the mobile signage fireman and put the extinguisher on the base. in case of emergency the extinguisher is easily located and quickly at hand.



information

pannello di alluminio composito stampato, supporti in ottone cromato color argento satinato, profilo in alluminio anodizzato color argento, base verniciata a polvere

bedrucktes aluminiumverbund-paneeel, silber-matt verchromte messinghalter, silber eloxiertes aluminiumprofil, pulverlack-beschichtete metallbasis

printed aluminium composite panel, silver matt chrome-plated supports, silver anodized aluminium profile, powder coated metal base

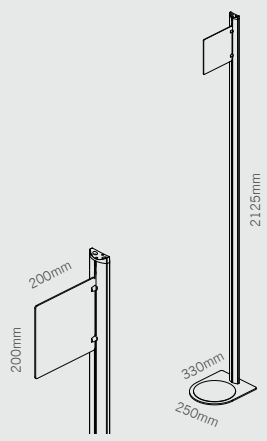

fireman

1 FRM2100 fireman, 1pc

secure drop

MADE IN EU controlled by KD

IT segnaletica adesiva con effetto 3D, resistente ai raggi UV, di lunga durata, a prova di graffio, con serigrafia a due colori, adatto ad applicazioni in ambienti con temperature da -30°C a +120°C. in fase di ordine si prega di specificare codice dell'articolo e numero del pittogramma desiderato. le norme relative alla segnaletica di sicurezza variano da nazione a nazione. vi preghiamo quindi di verificare se i pittogrammi offerti corrispondono alle normative sulla segnaletica di sicurezza del vostro paese.

DE selbstklebende beschilderung mit 3D-linseneffekt, uv-beständig, langlebig, kraftfest, mit 2-farb siebdruck, für temperaturen von -30°C bis +120°C. bei bestellung bitte artikelcode um die nummer des gewünschten motifs ergänzen. die normen der sicherheitsbeschilderung sind national unterschiedlich. prüfen sie daher, ob diese motive ihren nationalen normen zur sicherheitsbeschilderung entsprechen.

EN self-adhesive signage labels with 3D-lens-effect, uv-resistant, durable, scratch-resistant. with 2 colour silk screen print, for temperatures from -30°C up to +120°C. in case of order please complete the item code with the number of the favored symbol. as the norms for security signage differ from country to country, we ask you to check whether the symbols correspond with your national regulations.

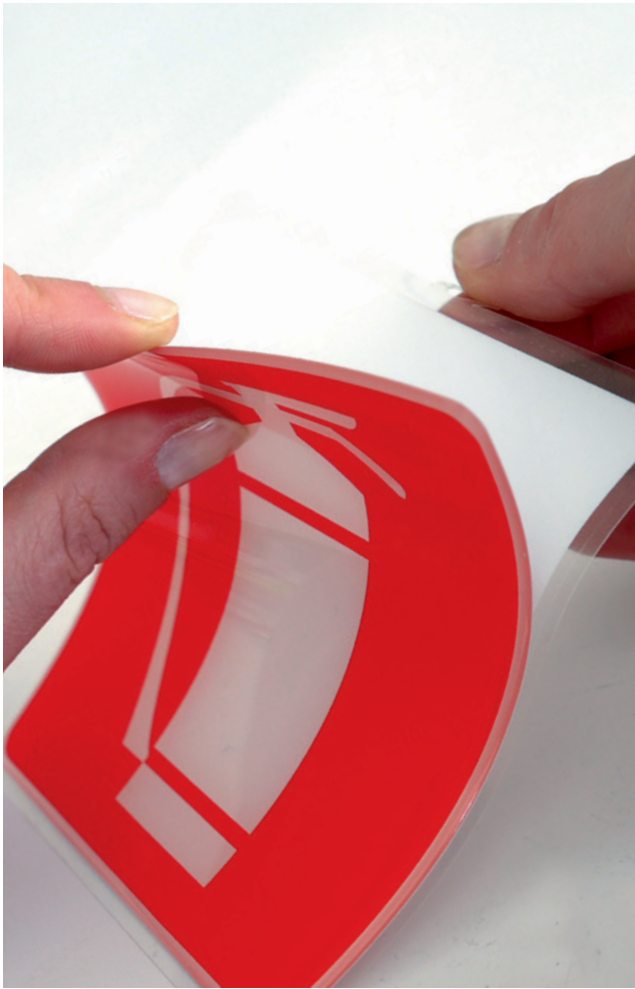

new standard ISO EN 7010

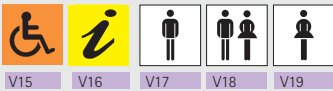

V15 V16 V17 V18 V19



P002 P020 P004 P013 W012 W001 W014



F001 F002 F005 E003 E007 E002 E001



V28 V32

V28+V32 possono essere utilizzati solo in combinazione, a norma di legge

V28+V32 dürfen laut norm nur in kombination verwendet werden

use V28+32 only in combination with other symbols, standard: no single use



E002V28R E001V28L E001V28D



E002V32RD E001V32LD E002V32RU E001V32LU

information



secure drop

1	FSC100100	<input type="checkbox"/>	100x100mm, 1pc
2	FSC100200	<input type="checkbox"/>	100x200mm, 1pc



metal drop

MADE IN EU controlled by KD

IT segnaletica adesiva con effetto 3D, dall'aspetto di acciaio spazzolato, resistente ai raggi UV, di lunga durata, a prova di graffio, con serigrafia a due colori, adatto ad applicazioni in ambienti con temperature da -30°C a +120°C. in fase di ordine si prega di specificare codice dell'articolo e numero del pittogramma desiderato. le norme relative alla segnaletica di sicurezza variano da nazione a nazione. vi preghiamo quindi di verificare se i pittogrammi offerti corrispondono alle normative sulla segnaletica di sicurezza del vostro paese.

DE selbstklebende beschilderung mit 3D-linseneffekt, wirkt wie gebürsteter stahl, uv-beständig, langlebig, kraftfest, mit 2-farb siebdruck, für temperaturen von -30°C bis +120°C. bei bestellung bitte artikelcode um die nummer des gewünschten motifs ergänzen. die normen für sicherheitsbeschilderung sind national unterschiedlich. prüfen sie daher, ob das gewählte motiv ihren nationalen normen zur sicherheitsbeschilderung entspricht.

EN self-adhesive signage labels with 3D-lens-effect, looks like brushed stainless steel, uv-resistant, durable, scratch-resistant. with 2 colour silk screen print, for temperatures from -30°C up to +120°C. when ordering please complete the item code with the number of the favored symbol. as the norms for security signage differ from country to country, we ask you to check whether the symbols correspond with your national regulations.

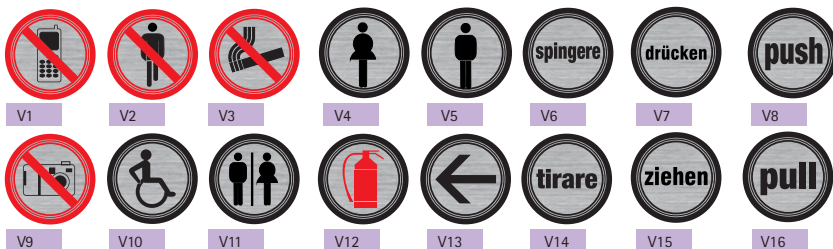

doppio effetto visivo: elegante aspetto metallico, di acciaio spazzolato, e profondità data dall'effetto 3D.

wirkt doppelt gut: im hintergrund edler metall-look und tiefenwirkung durch den 3D-linseneffekt

elegant and stylish: noble metal in the background and depth effect thanks to the 3D resin technique

information



metal drop

1	FMD50		ø50mm, 1pc
2	FMD100		ø100mm, 1pc



4

safepix wall 200x200mm
art. SFW200200V18



safepix wall

MADE IN EU design by KD

IT segnaletica di sicurezza di alta qualità : vetro temperato di sicurezza serigrafato sul retro con i più comuni pittogrammi. il montaggio viene realizzato con pixfix, il nostro sistema invisibile di montaggio a muro semplice ma intelligente. in fase di ordine si prega di specificare codice dell'articolo e numero del pittogramma desiderato. le norme relative alla segnaletica di sicurezza variano da nazione a nazione. vi preghiamo quindi di verificare che i pittogrammi offerti corrispondano effettivamente alle normative sulla segnaletica di sicurezza del vostro paese.

DE hochwertige sicherheitsbeschilderung: temperiertes sicherheitsglas rückseitig besiedruckt mit gängigen motiven. die montage erfolgt mit pixfix, unserem cleveren und einfachen wand-montage system. bei bestellung bitte artikelcode um die nummer des gewünschten motivs ergänzen. die normen der sicherheitsbeschilderung sind national unterschiedlich. prüfen sie daher, ob diese motive ihren nationalen normen zur sicherheitsbeschilderung entsprechen.

EN high grade security signage: tempered glass with a silkscreen print of most common symbols on rear side. the mounting is easy and convenient with our smart pixfix. when ordering please complete the item code with the article number of the requested symbol. as the norms for security signage differ from country to country, we ask you to check whether the symbols correspond with your national regulations.



montare pixfix a parete e inserirvi safepix. montaggio semplice e veloce.

pixfix einfach wandmontieren und das safepix motiv einschieben. fertig.

simply wallmount pixfix and insert the pixfix sign. that's it.

ulteriori informazioni pag.
mehr details s.
more information p.

347



safepix wall

1	SFW150150		safepix wall 150x150mm, 1pc
2	SFW150300		safepix wall 150x300mm, 1pc
3	SFW170370		safepix wall 170x370mm, 1pc
4	SFW200200		safepix wall 200x200mm, 1pc
5	SFW200400		safepix wall 200x400mm, 1pc
6	SFW250250		safepix wall 250x250mm, 1pc



safepix glass

MADE IN EU design by KD

IT vi offriamo anche i pittogrammi safepix su vetro temperato di sicurezza senza fissaggio posteriore, così potrete scegliere liberamente quello che preferite. i vetri sono serigrafati nella parte posteriore. si prega di testare il fissaggio con sistemi di terzi prima dell'installazione.

DE wir bieten ihnen die safepix motive auf temperiertem sicherheitsglas auch einzeln an. sie können so die befestigung selbst auswählen. die gläser sind rückseitig besiedruckt. befestigungen mit systemen dritter unbedingt vorab testen.

EN additionally we can provide you with the safepix images on tempered glass by itself. that way you can choose your preferred mounting system. the glass is silk screen printed on the rear side. fixing with a third party systems to be tested first.

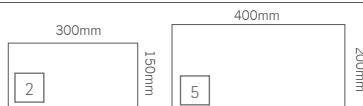
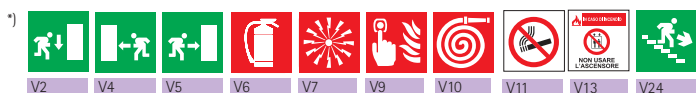

*] simboli norma uni fino ad esaurimento scorte | symbole nach altem standard solange vorrat reicht | graphics old standard while stock lasts

new standard ISO EN 7010

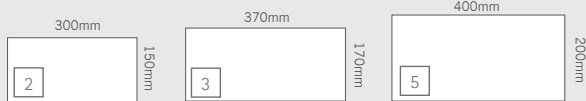
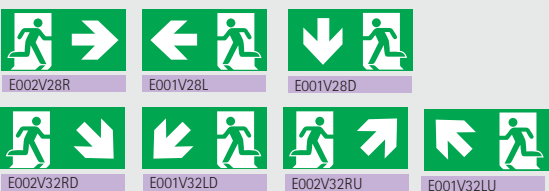
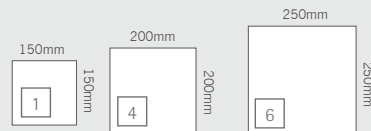
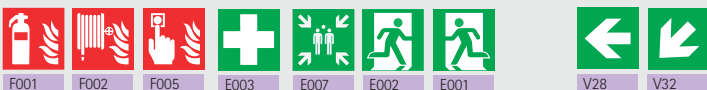

glasses

1	SFVE150150	150x150mm, 1pc
2	SFVE150300	150x300mm, 1pc
3	SFVE170370	170x370mm, 1pc
4	SFVE200200	200x200mm, 1pc
5	SFVE200400	200x400mm, 1pc
6	SFVE250250	250x250mm, 1pc

combinations

V28+V32 possono essere utilizzati solo in combinazione, a norma di legge

V28+V32 dürfen laut norm nur in kombination verwendet werden

use V28+32 only in combination with other symbols, standard: no single use



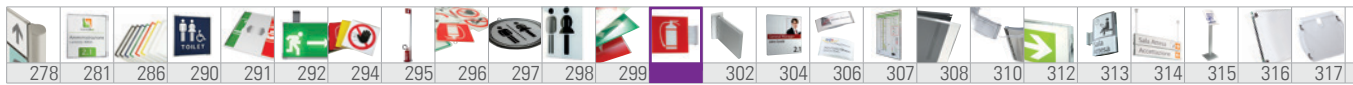

safepix flag

MADE IN EU design by KD

IT segnaletica di sicurezza a bandiera o a soffitto realizzata in vetro temperato di sicurezza serigrafato sul retro con i più comuni pittogrammi. questo utilizzo è reso possibile dalla combinazione di fisso flag con i pannelli safepix. in fase di ordine si prega di specificare codice dell'articolo e numero del pittogramma desiderato. le norme relative alla segnaletica di sicurezza variano da nazione a nazione. vi preghiamo quindi di verificare che i pittogrammi offerti corrispondano effettivamente alle normative sulla segnaletica di sicurezza del vostro paese.

DE sicherheitsbeschilderung mit rückseitig besiedrucktem sicherheitsglas als decken- oder fahnschild. wandhalter fisso flag in kombination mit den safepix schildern machts möglich. bei bestellung bitte artikelcode um die nummer des gewünschten motivs ergänzen. die normen der sicherheitsbeschilderung sind national unterschiedlich. prüfen sie daher, ob diese motive ihren nationalen normen zur sicherheitsbeschilderung entsprechen.

EN safety signage with a silkscreen printed tempered glass as a flag or ceiling sign: wall fixing fisso flag in combination with the safepix signs. when ordering please complete the item code with the article number of the requested symbol. as the norms for security signage differ from country to country, we ask you to check whether the symbols correspond with your national regulations.

new standard ISO EN 7010

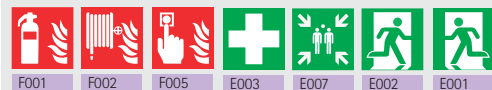
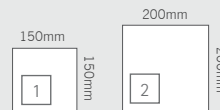

V28+V32 possono essere utilizzati solo in combinazione, a norma di legge

V28+V32 dürfen laut norm nur in kombination verwendet werden

use V28+32 only in combination with other symbols, standard: no single use

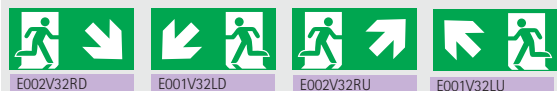

A **2**
safepix flag 200x200mm
art. SPFL200200V16

information

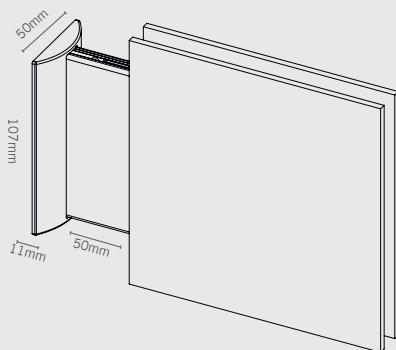

302 ulteriori informazioni pag. mehr details s. more information p.



B 4
safepix flag 200x400mm



C 2
safepix flag 200x200mm

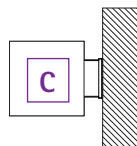
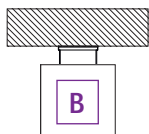
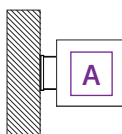
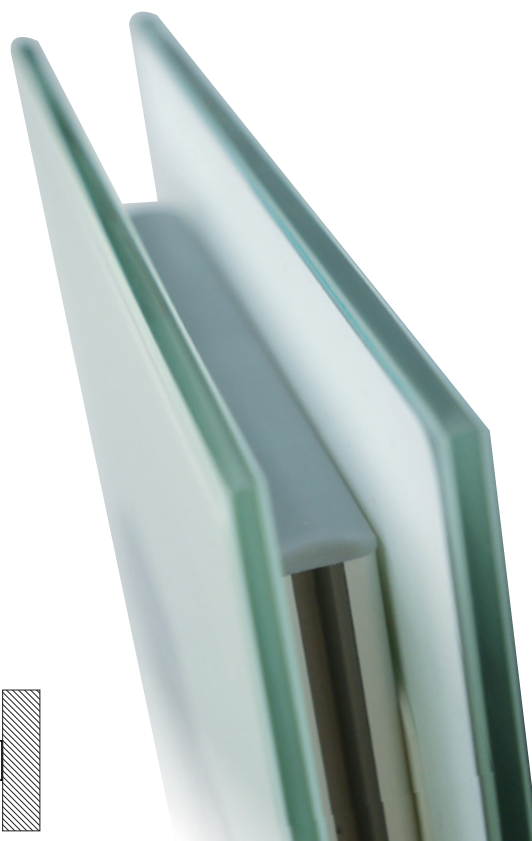

1	SPFL150150		1	SPC150150		1	SPFR150150		150x150mm, 1pc
2	SPFL200200		2	SPC200200		2	SPFR200200		200x200mm, 1pc
3	SPFL150300		3	SPC150300		3	SPFR150300		150x300mm, 1pc
4	SPFL200400		4	SPC200400		4	SPFR200400		200x400mm, 1pc



fisso flag

MADE IN EU design by KD

IT geniale, flessibile e multiuso: grazie a fisso flag la vostra fantasia e la vostra creatività potranno spaziare anche nell'ambito della segnaletica di sicurezza a bandiera e a soffitto. sul profilo di alluminio è possibile fissare pannelli dei più svariati materiali. grazie inoltre all'accessorio flag joint , il vostro sistema può anche diventare modulare. in questo modo anche le creazioni più complesse diventano semplici da realizzare.

DE genial, flexibel, vielfältig: mit fisso flag können sie richtig kreativ werden bei decken- und fahnenbeschilderungen. auf das aluminiumprofil befestigen sie paneele unterschiedlichster materialien. mit dem flag joint wird das ganze dann modular erweitert. so lassen sich unterschiedlichste anforderungen ganz einfach realisieren.

EN smart, flexible and versatile: with fisso flag new creative ways for the flag and ceiling signage will open up for you. panels of all kinds of materials are fixed to the aluminium profile directly. with the flag joint the system extends modularly. thus you will easily implement systems of all sorts.



1-4
alluminio anodizzato color argento, zamac in color argento satinato, materiale sintetico color grigio satinato

silber eloxiertes aluminium, silbermatt verchromter metalldruckguss, silbergrauer kunststoff

silver anodised aluminium, silver matt chromed metal die cast, silver grey plastic

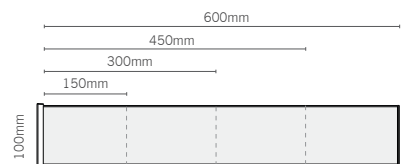

information

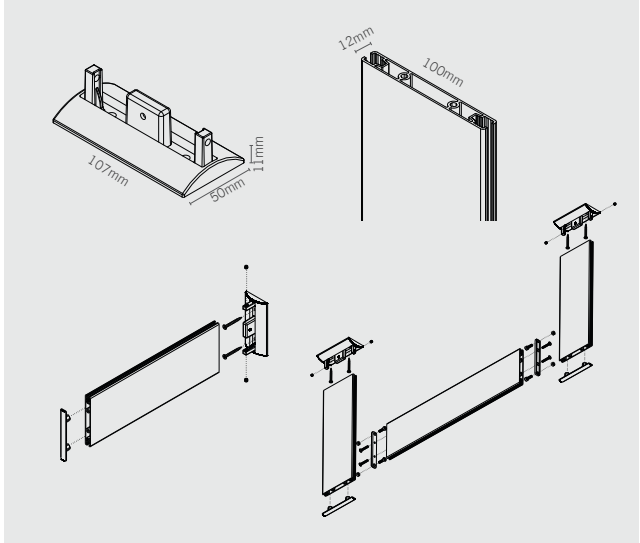

5-8
alluminio anodizzato color argento, zamac in color argento satinato

silber eloxiertes aluminium, silbermatt verchromter metalldruckguss

silver anodised aluminium, silver matt chromed metal die cast

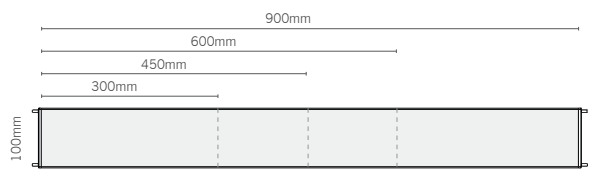

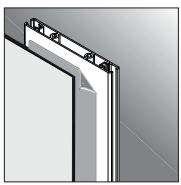
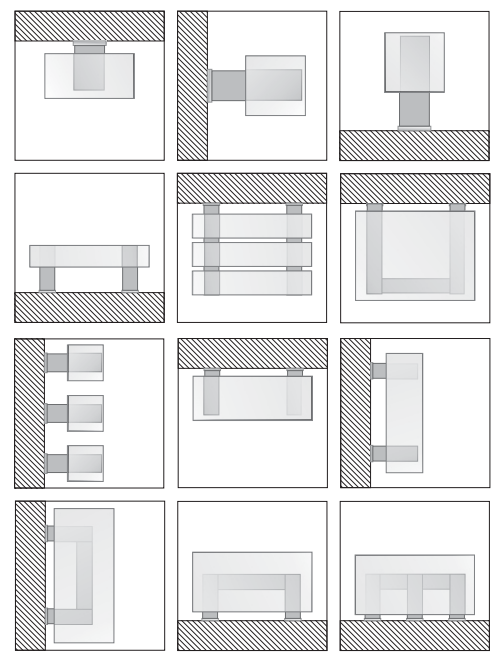

biadesivo
doppelkleber
double sided tape

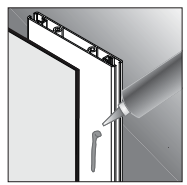

silicone o colla
silikon oder flüssigkleber
silicone or glue

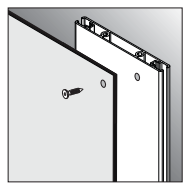

viti
schrauben
screws

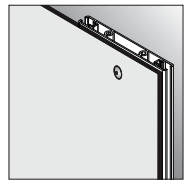

rivetti
nieten
rivets

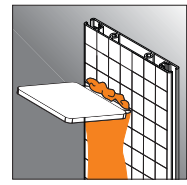

serigrafia
siebdruck
silk screen print

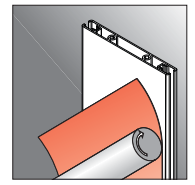

stampa digitale laminata
digitaldruck aufkaschieren
laminate digital print

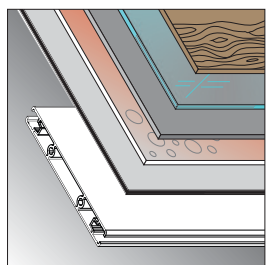

assemble with:
wood
glass
metall
synthetic
aluminium composite panels

fisso flag



1	FFG150	fisso flag 150mm, 1pc
2	FFG300	fisso flag 300mm, 1pc
3	FFG450	fisso flag 450mm, 1pc
4	FFG600	fisso flag 600mm, 1pc
5	FFJ300	fisso flag joint 300mm, 1pc
6	FFJ450	fisso flag joint 450mm, 1pc
7	FFJ600	fisso flag joint 600mm, 1pc
8	FFJ900	fisso flag joint 900mm, 1pc



printosign

MADE IN EU design by KD

IT le targhe printosign sono in alluminio anodizzato color argento, hanno uno spessore di 3mm, presentano gli angoli arrotondati e i bordi smussati. printosign si può personalizzare su entrambi i lati, con una stampa diretta o con un laminato. vi offriamo le targhe printosign in molti dei formati più comuni, da fissare a parete con pixfix oppure con il resistente ma removibile biadesivo a peduncoli plastici. entrambe le soluzioni sono semplici e veloci da montare.

DE printosign schilder sind aus 3mm starkem silber eloxiertem aluminium mit abgerundeten ecken und gefasteten kanten. sie können beidseitig mit direktdruck oder aufkaschieren personalisiert werden. wir bieten ihnen die printosign schilder in vielen gängigen formaten zur wandbefestigung mit pixfix oder stark haftendem, wieder lösbarem pilzkopfband an. beide systeme sind einfach und schnell zu montieren.

EN printosign panels are made of 3mm thick silver anodized aluminium with rounded corners and beveled edges. you can customize them on both sides with digital prints or laminates. we offer the printosign panels in many common sizes for wall mounting with pixfix or removable mushroom head adhesive tape. both systems are quickly and easily mounted to the wall.



information

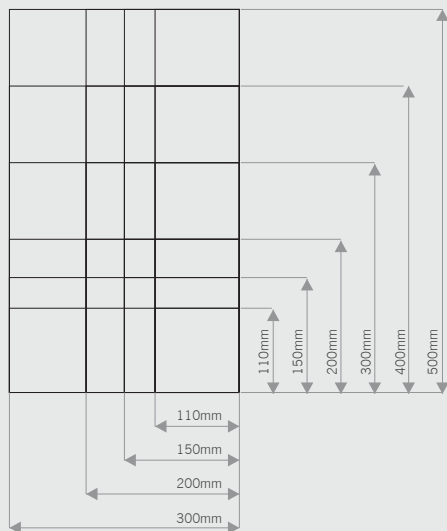



A

attaccare printosign al pixfix con il biadesivo e poi inserirlo nel supporto montato a parete; facile da cambiare in qualsiasi momento.

printosign mit doppelkleber auf pixfix fixieren und dann einfach auf die wandmontierte halterung schieben, jederzeit abnehmbar

glue printosign to the pixfix and then simply click it to the wallmounted pixfix wall support, removable anytime



B

montaggio a parete su superfici lisce con biadesivo a peduncoli plastici; l'applicazione non prevede fori.

befestigung mit starkhaftendem pilzkopf-doppelklebeband, ohne bohrung für glatte oberflächen

mushroom head adhesive tape allows the quick mounting to smooth surfaces without the need for drilling holes

printosign

A

B

1	FTSP110110AL	110x110mm	FTSV110110AL
2	FTSP110200AL	110x200mm	FTSV110200AL
3	FTSP110300AL	110x300mm	FTSV110300AL
4	FTSP110400AL	110x400mm	FTSV110400AL
5	FTSP110500AL	110x500mm	FTSV110500AL
6	FTSP150150AL	150x150mm	FTSV150150AL
7	FTSP150200AL	150x200mm	FTSV150200AL
8	FTSP150300AL	150x300mm	FTSV150300AL
9	FTSP150400AL	150x400mm	FTSV150400AL
10	FTSP150500AL	150x500mm	FTSV150500AL
11	FTSP200200AL	200x200mm	FTSV200200AL
12	FTSP200300AL	200x300mm	FTSV200300AL
13	FTSP200400AL	200x400mm	FTSV200400AL
14	FTSP200500AL	200x500mm	FTSV200500AL
15	FTSP300300AL	300x300mm	FTSV300300A
16	FTSP300400AL	300x400mm	FTSV300400AL
17	FTSP300500AL	300x500mm	FTSV300500AL



badge leggero e tridimensionale grazie alla nuova tecnica di chiusura. fissaggio a spillo.

dreidimensionales, leichtes schild dank neuartiger klapp-technik. befestigung mit nadel.

lightweight three-dimensional badge with folding technique. attached with a safety pin.



robusto badge piatto in materiale plastico con chiusura magnetica.

robustes, flaches kunststoffschild mit integriertem kraftmagnet.

robust, flat badge with integrated strong magnet.



raffinato ed armonioso grazie al fissaggio magnetico e alla forma leggermente arrotondata.

passt sich durch die integrierte magnetbefestigung und leichte rundung harmonisch an.

thanks to the integrated magnet and its rounded shape the polar matches perfectly with every look.

badgepoint®

1	BPEV40TR	event 40, 37x75mm, 1pc
2	BPEV60TR	event 60, 54x85mm, 1pc
3	BPOF40AR	office „classic“, 37x75mm, 1pc
4	BPPO35AR	polar® „metal“, 34x74mm, 1pc

printbadge



il badge squisitamente trendy in pregiato materiale sintetico nichelato e con efficace fissaggio magnetico

trendiger badge in hochwertig vernickeltem kunststoff mit extra starker magnetbefestigung

trendy badge in high-grade nickel-plated finish with extra strong magnetic fastening

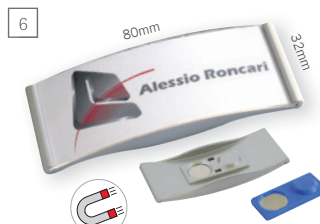

di aspetto elegante, in materiale sintetico metallizzato argento, a fissaggio magnetico particolarmente efficace

elegante optik in kunststoff silbermetallisch mit sicherer extra starker magnetbefestigung

elegant look in silver metal with safe extra strong magnetic fastening



di formato avvincente, in materiale sintetico argentato, a fissaggio magnetico particolarmente efficace

ansprechendes format in kunststoff silber mit extra starker magnetbefestigung

appealing format in silver with extra strong magnetic fastening

printbadge small/medium/large

5	PRB6315NI *	nickel-plated, 15x62mm, 1pc
6	PRB7832AR *	silver, 32x75mm, 1pc
7	PRB7537AR *	silver, 37x75mm, 1pc

* nessuna distribuzione in e verso la germania | kein vertrieb in und nach deutschland | no distribution in or towards germany



linfor

 MADE IN EU design by KD

IT leggero di aspetto e di peso, linfor è la soluzione più conveniente e veloce per l'esposizione di fogli singoli, in particolare per applicazioni su superfici lisce. materiale plastico stampato ad iniezione, foglio protettivo flessibile e biadesivo trasparente : per una garanzia di tenuta, uniformità delle dimensioni ed un cambio veloce delle informazioni. linfor è disponibile nei formati DIN più comuni.

DE schlank in optik und gewicht ist linfor die günstige und schnelle einzelblatt präsentation v.a. für montage auf glatten oberflächen. kunststoff-spritzguss mit flexibler cover-folie und transparentem doppelkleber garantieren masstreue und unkompliziertes auswechseln. erhältlich ist linfor in den gängigen DIN formaten.

EN lean design and light weight characterize linfor, the perfect low budget information presenter. it is best for mounting on smooth surface like glass. plastic die-cast with flexible cover sheet and transparent double adhesive tape guarantee accurate dimensions and easy exchange. linfor is available in the most common DIN formats.

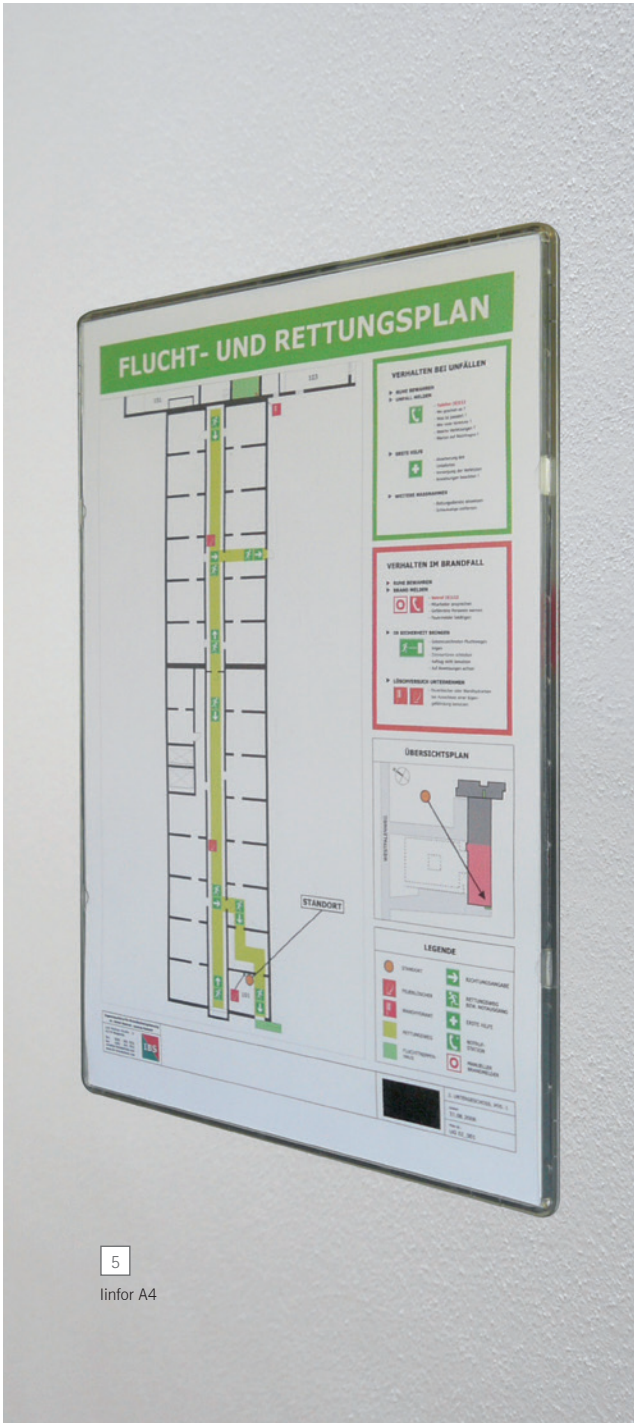

5
linfor A4

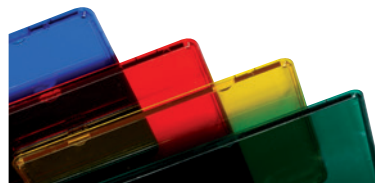
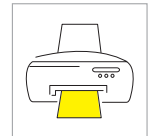

alti colori pag.
mehr farben s.
more colours p.

13

information

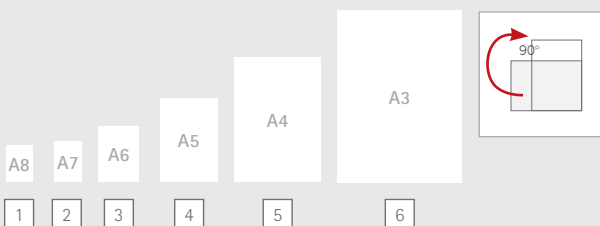

linfor

1	LINFORA8TR	linfor A8 transparent, 1pc
2	LINFORA7TR	linfor A7 transparent, 1pc
3	LINFORA6TR	linfor A6 transparent, 1pc
4	LINFORA5TR	linfor A5 transparent, 1pc
5	LINFORA4TR	linfor A4 transparent, 1pc
6	LINFORA3TR	linfor A3 transparent, 1pc

**NEW
PRODUCT**



smartquick

 MADE IN EU design by KD

IT sottile, utile e facile da montare. il nostro smartquick in polycarbonato stampato in pressofusione si monta molto facilmente fissandolo con viti o tramite nastro biadesivo che troverete all'interno della confezione nel caso di applicazione su superfici lisce come ad esempio in vetro. ideale per quando avete bisogno di esporre informazioni in supporti senza cornice proteggendole dalla polvere. per cambiare l'informazione basta semplicemente fare pressione sul lato destro o sinistro della copertura trasparente. il retro è di color nero, perfetto come sfondo.

DE klein, praktisch und schnell montiert: unser smartquick aus hochwertigem polycarbonat spritzguss lässt sich einfach und schnell wandmontieren. ob mit schraube und dübel oder doppelkleber auf glatten oberflächen, der smartquick ist überall dort im einsatz, wo sie informationen rahmenlos und staubgeschützt präsentieren wollen. zum austausch öffnet sich das transparente cover nach links oder rechts. die rückwand ist schwarz und bildet den perfekten hintergrund für ihre information.

EN small, convenient and quickly mounted: our smartquick made of high-grade die-cast polycarbonate. it is easily wall mounted with screws but you can attach it also to smooth surfaces such as glass with the double sided adhesive tapes provided. smartquick is perfect when you want to display information framelessly and dust-proof. to exchange your information simply click open the transparent cover to the left or to the right. the rear part is black in colour, making the perfect background for your information.

information

polycarbonato stampato in pressofusione: copertura trasparente e retro color nero

polycarbonat-spritzguss: cover transparent, rückwand schwarz

die-cast polycarbonate: cover transparent, rear part black

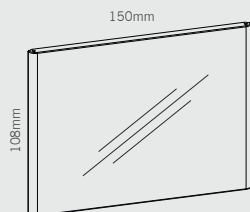

fissaggio viti

montage mit doppelkleber

mounting with double adhesive tape

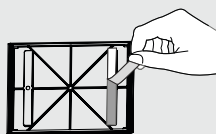

fissaggio nastro biadesivo

montage mit schrauben

mounting with screws

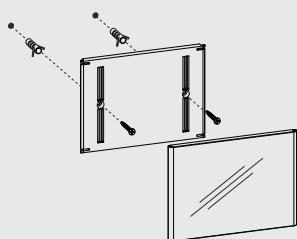

smartquick

1 SMQ105150SZ

smartquick 105x150mm 1pc



1
smartquick



sottile, dall'aspetto elegante e di facile montaggio oltre che veloce nel cambiamento dell'informazione

schmale, elegante optik - schnell montiert, leicht ausgetauscht

slim, elegant look and easily mounted, info quickly exchanged



3
pixquick A6 large

pixquick®

MADE IN EU design by KD patented

IT pixquick é ideale come espositore da banco o da parete, é a prova di polvere e non ha cornici laterali che impediscano la corretta visione dell'informazione. ideale soprattutto proprio per quelle informazioni che debbano essere cambiate frequentemente. pixquick si può aprire da entrambi i lati, semplicemente spostando il pannello frontale o togliendolo completamente: basta una leggera pressione sugli angoli. policarbonato di alta qualità ed un processo produttivo moderno e tecnologico garantiscono al prodotto design, durata di vita notevole, uniformità delle dimensioni ed un aspetto decisamente gradevole. particolarmente elegante si presenta pixquick silver con il retro verniciato di color argento metallizzato.

DE pixquick als funktioneller thekenaufsteller oder als wanddisplay präsentiert optimal häufig zu wechselnde info, rahmenlos und staubgeschützt. zum öffnen kann das frontpaneel nach beiden seiten aufgeklappt oder komplett abgenommen werden. ein einfacher druck auf die ecken genügt. hochwertiges polycarbonat und produktionsverfahren nach dem letzten stand der technik garantieren ein langlebiges designprodukt mit masstreue und perfekter optik. besonders elegant und hochwertig wirkt pixquick silver mit seiner silbermetallisch lackierten rückseite.

EN pixquick is a perfectly functional frameless and dust proof counter or wall display, ideal for information that has to be changed frequently. the front panel can be opened in either direction or removed completely by simply pushing the corners. high grade polycarbonate and a state-of-the-art production process guarantees a long-lasting design product with constant size and a perfect look. pixquick silver is especially elegant with its metallic silver coated rear part.

information

per aprire sganciare o rimuovere il pannello frontale - A3 solo rimuovere completamente

zum öffnen frontpaneel aufklappen oder abnehmen - A3 frontpaneel nur komplett abnehmbar

to open: expand or remove front panel - A3 front panel only remove



girare pixquick per cambiare facilmente formato da orizzontale a verticale e viceversa

im handumdrehen von vertikal auf horizontal umstellen

just rotate for vertical or horizontal position



possibilità di diversi gradi di inclinazione cambiando la posizione del supporto da tavolo

verschiedene neigungen möglich durch verstellen der stütze

different inclinations by changing the support

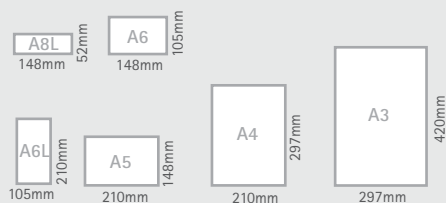

ulteriori informazioni pag. mehr details s. more information p.

6-9

pixquick A



1	PQA8L	pixquick A8L without support, 1pc	
2	PQA6 *	pixquick A6, 1pc	
3	PQA6L *	pixquick A6L, 1pc	
4	PQA5	pixquick A5 incl. support, 1pc	
5	PQA4	pixquick A4 incl. support, 1pc	
6	PQA3	pixquick A3, 1pc	
7	PQSA6PL	support for A6 and A6 large, 1pc	

* ordinare supporto PQSA6PL a parte | stütze PQSA6PL extra bestellen | order support PQSA6PL extra

pixquick silver B



8	PQARA8L	pixquick silver A8L, 1pc	
9	PQARA6	pixquick silver A6, 1pc	
10	PQARA6L	pixquick silver A6L, 1pc	
11	PQARA5	pixquick silver A5, 1pc	
12	PQARA4	pixquick silver A4, 1pc	
13	PQARA3	pixquick silver A3, 1pc	





6
pixquick A3



PUSH

A



1-6
pixquick realizzato con stampa ad iniezione in policarbonato trasparente
pixquick in transparentem polycarbonat-spritzguss
pixquick in transparent die cast polycarbonate



supporto da banco per formati A6 e A6L in PETG
stütze in PETG für format A6 und A6L
support for A6 and A6L made of PETG



B



8-13
pixquick realizzato con stampa ad iniezione in policarbonato trasparente, retro verniciato color argento
pixquick in transparentem polycarbonat-spritzguss, rückseite silber lackiert
pixquick in transparent die cast polycarbonate, rear part varnished silver





1
pixquick wall 105x600mm

pixquick® wall

MADE IN EU design by KD

IT in linea con la nuova serie di segnaletica pixquick, il nuovo formato da parete: l'informazione viene presentata senza cornici laterali, protetta dalla polvere e sarà facile sostituirla in qualsiasi momento. questo formato è particolarmente indicato per sistemi di segnaletica di direzione in edifici pubblici e grandi strutture, dove le indicazioni e le direzioni devono essere perfettamente visibili anche ad una certa distanza. il sistema pixquick è flessibile: le informazioni stampate su carta sono velocemente e semplicemente intercambiabili.

DE passend zur pixquick signage serie das neue mass für die wand: rahmenlos und staubgeschützt wird die information präsentiert und kann jederzeit leicht ausgetauscht werden. besonders geeignet ist dieses mass für leitssysteme in öffentlichen gebäuden und grossen strukturen wo wegweiser auch aus einiger distanz klar und leicht erkennbar sein müssen. dabei ist das pixquick system jederzeit flexibel: auf papier gedruckte information wird einfach ausgetauscht.

EN matching with the pixquick signage series the new size for walls: frameless and dust-proof for a perfect information presentation. the information is printed on paper and can be easily exchanged anytime. thus you stay flexible with your signage. we recommend this system, especially for public buildings and big structures, where signs need to be clearly readable also from a certain distance.

other possible combinations!

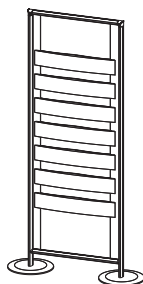

information

stampa ad iniezione in policarbonato trasparente, materiale per montaggio incluso

transparenter polycarbonat spritzguss, inkl. montagematerial

transparent die-cast polycarbonate, mounting material incl.



ulteriori informazioni pag. 302
mehr details s. 302
more information p. 302

pixquick wall

1 PQ105600

pixquick 105x600mm, 1pc

302

pixquick® flag

MADE IN EU design by KD

IT pixquick flag è il nuovo sistema di segnaletica bifacciale a bandiera, che mantiene ed esalta tutte le caratteristiche proprie della linea piquick: l'informazione può essere stampata semplicemente anche su carta, introdotta nel pixquick e lì sostituita in qualsiasi momento. Il pixquick flag è disponibile in diversi formati. Il sistema di aggancio a muro, realizzato in metallo pressofuso color argento satinato, garantisce un fissaggio sicuro al prodotto. segnaletica pixquick: la migliore scelta per un sistema di guida semplicemente flessibile.

DE das doppelseitige auslegerschild der pixquick signage serie überzeugt mit allen vorteilen der pixquick reihe: die information wird einfach ausgedruckt und kann jederzeit schnell ausgetauscht werden. erhältlich ist der pixquick flag in vielen formaten. der hochwertige wandhalter aus silbermattem metall-druckguss hält den pixquick flag sicher an der wand. pixquick signage: ihre wahl für ein durchgängig gestaltetes äusserst flexibles wegleitsystem.

EN the double-side flag sign of the pixquick signage series convinces with all the advantages of the pixquick design: the information can be easily printed on paper and can be exchanged anytime. the pixquick flag is available in many different sizes. the high-grade wall support made of silver matt die-cast metal mounts the pixquick flag safely to the wall. pixquick signage: your choice for a consistently designed yet very flexible signage system.



4
pixquick flag A4

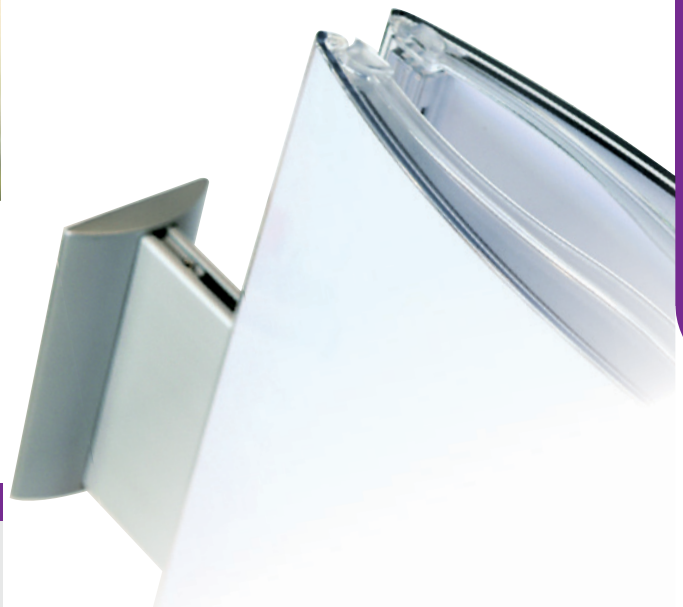
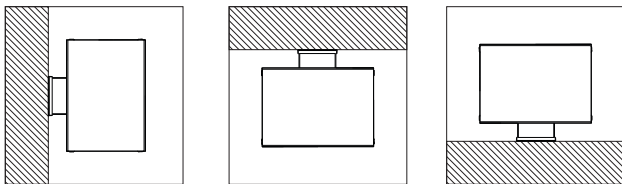

information

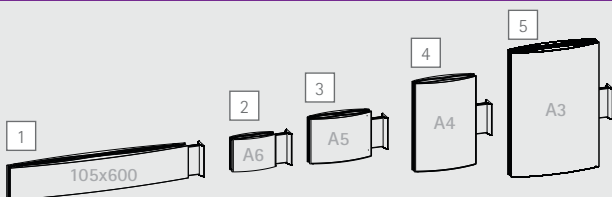

segnaletica a muro in metallo pressofuso, color argento, stampa ad iniezione in policarbonato trasparente

silber veredelter metall-druckguss wandhalter, polycarbonat spritzguss transparent

wall support made of silver plated metal die-cast, die-cast polycarbonate transparent

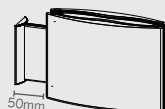

pixquick flag

1	PQFG105600	pixquick flag 105x600mm, 1pc
2	PQFGA6	pixquick flag A6, 1pc
3	PQFGA5	pixquick flag A5, 1pc
4	PQFGA4	pixquick flag A4, 1pc
5	PQFGA3	pixquick flag A3, 1pc



pixquick® suspension

MADE IN EU design by KD



IT il vostro sistema di segnaletica di direzione pixquick viene oggi arricchito di un nuovo fondamentale componente : pixquick ceiling, indicatore bifacciale a soffitto. il policarbonato trasparente realizzato tramite stampa ad iniezione e privo di cornici laterali garantirà alle vostre informazioni stampate su carta una protezione antipolvere. le informazioni potranno essere sostituite in qualsiasi momento senza l'utilizzo di utensili. il fissaggio a soffitto regge una portata di max. 5 targhe.

DE ihre wegleitsysteme mit pixquick signage werden durch die doppelseitigen, deckenabgehängten pixquick ceiling perfekt ergänzt. transparenter polycarbonat-spritzguss präsentiert die auf papier gedruckte info rahmenlos und staubgeschützt. der austausch der info ist jederzeit ohne werkzeug ganz einfach möglich. die deckenbefestigung ist für maximal fünf schilder ausgelegt.

EN the pixquick ceiling perfectly completes your guideline system with pixquick signage. the transparent polycarbonate die-cast displays your paper print framelessly and dust-proof. the exchange is easily without tools at anytime. the ceiling support is designed for a maximum of five signs in total.

information

stampa ad iniezione in policarbonato trasparente, materiale di fissaggio a soffitto in policarbonato, cavi in acciaio 2x1m

transparenter polycarbonat spritzguss, deckenbefestigung kunststoff, stahlseil 2x1m

transparent die-cast polycarbonate, synthetic ceiling support, steel wire 2x1m

stampa ad iniezione in policarbonato trasparente, sistema di congiunzione tra le targhe in materiale sintetico

transparenter polycarbonat spritzguss, kunststoff-verbinder für erweiterungsmodul

transparent die-cast polycarbonate, synthetic sign connector for modular system

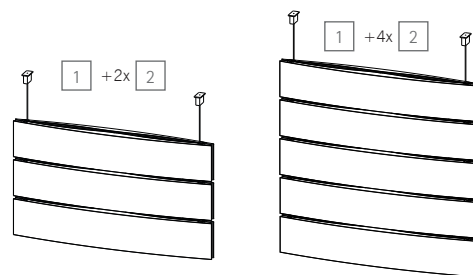
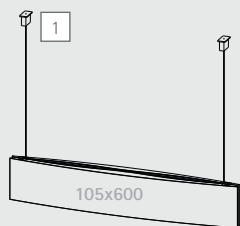

pixquick suspension

1	PQXS105600	pixquick suspension incl. wire, 1pc
2	PQXSM105600	pixquick module for suspension, 1pc

pixquick® floor

MADE IN EU design by KD



2
pixquick floor

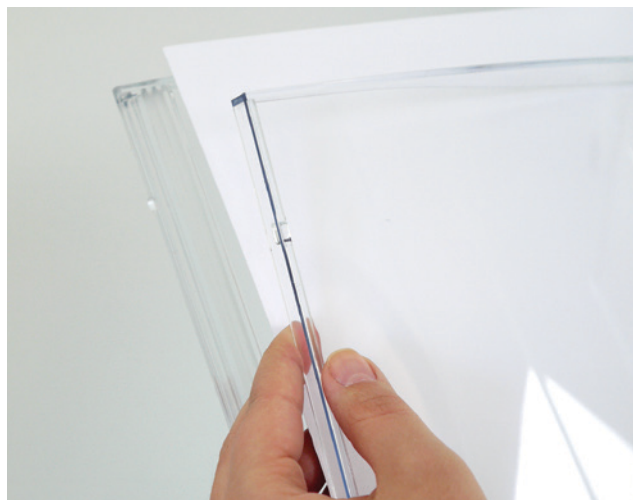

IT dalla nostra linea pixquick nasce pixquick floor, un display per informazioni da terra autoportante disponibile nei formati A4 e A3. l'espositore senza cornice può essere aperto da entrambi i lati ed è a prova di polvere. il cambio dell'informazione è quindi facile e veloce. una base stabile e il profilo in alluminio anodizzato color argento rendono questo display semplicemente perfetto.

DE aus unserer pixquick signage serie das freistehende bodendisplay für die informationspräsentation in A4 oder A3. der infohalter kann links oder rechts geöffnet werden. ihre info ist staubgeschützt und wird rahmenlos gezeigt. der austausch ist jederzeit ganz einfach möglich. ein stabiler standfuss und das silber eloxierte alu-profil runden dieses display ab.

EN from our pixquick signage series we present to you now the freestanding floor display for information in A4 or A3. the information support can be opened on both sides and it is dust-proof and frameless. content exchange is quick and easy. a stable base and the silver anodized aluminium profile makes this a perfect display.

information

tasche porta informazioni in policarbonato trasparente realizzate tramite stampa ad iniezione, alluminio anodizzato color argento, base in materiale sintetico verniciato in argento con di sostegno in metallo

infotasche transparenter polycarbonat spritzguss, silber eloxiertes aluminium, silber lackierter kunststoff-fuss mit gewichtplatte aus metall

transparent die-cast polycarbonate poster pocket, silver anodized aluminium

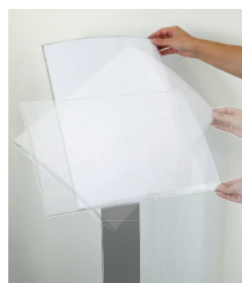
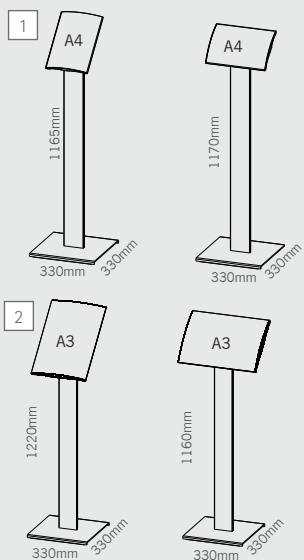

il pixquick può essere posizionato in orizzontale o verticale a seconda della necessità.

drehen sie einfach von horizontal auf vertikal oder umgekehrt, ganz nach bedarf!

simply turn from horizontal to vertical or vice versa, just as required!

pixquick floor

1	PQFRA4	pixquick floor A4, 1pc
2	PQFRA3	pixquick floor A3, 1pc

infoglass & steel15

 MADE IN EU design by KD

IT elegante sistema a sandwich in vetro e acciaio inox. il raffinato set per segnaletica di informazione e direzione. due lastre di infoglass nei 5 formati più comuni, complete rispettivamente di 2 o 4 distanziali steel 15 con anellini di protezione e materiale per il montaggio. fissaggio su vetro? nessun problema grazie a fisso rosett. fissaggio: sistema di fissaggio con chiusura di sicurezza, a prova di manomissioni. materiale: acciaio inox AISI304, testina sfaccettata, vetro di sicurezza temperato, 4 mm, angoli sfaccettati a 45°. distanza dalla parete: 15mm.

DE edles edelstahl-glas-sandwichsystem. das hochwertige set für information, orientierung und beschil-derung. zwei infogläser in fünf gängigen grössen komplett mit zwei bzw. vier steel15 haltern, glasschutzringen und montage-material. befestigung auf glas? mit fisso rosett kein problem. befestigung: stecksystm mit arretierung, manipulationssicher. material: halter: edelstahl AISI304, facettenschliff. glas:temperiertes sicherheitsglas, 4mm, kanten mit 45°-facetten-schliff. wandab-stand: 15mm.

EN noble sandwich-system in stainless steel and glass. the high-class set for information, orientation and signage. two infoglass in five common sizes completely with two resp. four steel15 spacers, glass protecting rings, screws and dowels. fastening on glass? no problem with fisso rosett. mounting: plug-interlocksystem, tamper-proof. material: spacer: stainless steel AISI304, faceted surface. glass: tempered glass, 4mm, edges grinded 45°. wall distance: 15mm.



price for this combination SETIG150

information



A7 (80x150mm): SETIGA7 1 set

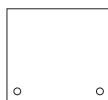

A6 (135x150mm): SETIGA6 1 set

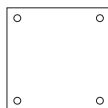

150x150: SETIG150 1 set



A4 (337x215mm): SETIGA4 1 set



A3 (460x300mm): SETIGA3 1 set



price for this combination
SETIQA4CM

set infoquick & midi

MADE IN EU design by KD

IT set completo a tasca per un cambio di informazioni facile e veloce. cambiare informazioni in ogni momento, senza utensili e velocemente? nessun problema grazie alla tasca infoquick. il set si compone di una tasca in plex nei 4 formati piú comuni e di 2 o 4 distanziali midi in argento satinato o cromo lucido e di materiale per il montaggio. fissaggio: sistema di fissaggio con chiusura laterale di sicurezza, a prova di manomissioni. materiale: distanziale in ottone con cromatura della superficie in color argento o cromo; pannello in acrilico trasparente piegato a tasca. distanza dalla parete: 21mm.

DE komplettset mit einschub: infowechsel schnell und bequem. info-austausch jederzeit ohne werkzeug, schnell und unkompliziert? mit der einschubtasche von infoquick kein problem. das infoset erhalten Sie in vier grössen komplett mit 2 oder 4 haltern fisso midi in silber oder chrom und montagematerial. befestigung: stecksystem mit arretierung, manipulationssicher. material: halter: messing oberflächenveredelt in silber und chrom. infoquick: acrylglas transparent, gebogen mit einschub. wandabstand: 21mm.

EN infoset with slide-in pocket: exchange quick and easy. information exchange anytime without any tools, fast and easy? that's no problem with the slide-in pocket of infoquick. the infoset comes in four sizes, completely with 2 or 4 fisso midi spacers, silver or chrome including screws and dowels. mounting: plug-interlocksystem, tamper-proof. material: spacers: brass, silver- or chrome-plated. wall distance: 21mm.



argento/silber/silver

A7 (52x148mm): SETIQA7AR 1 set

cromo/chrom/chrome

A7 (52x148mm): SETIQA7CM 1 set

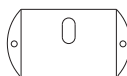

argento/silber/silver

A6 (105x148mm): SETIQA6AR 1 set

cromo/chrom/chrome

A6 (105x148mm): SETIQA6CM 1 set

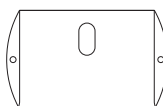

argento/silber/silver

A5 (210x148): SETIQA5AR 1 set

cromo/chrom/chrome

A5 (210x148): SETIQA5CM 1 set

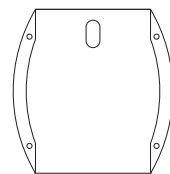

argento/silber/silver

A4 (297x210mm): SETIQA4AR 1 set

cromo/chrom/chrome

A4 (297x210mm): SETIQA4CM 1 set

information

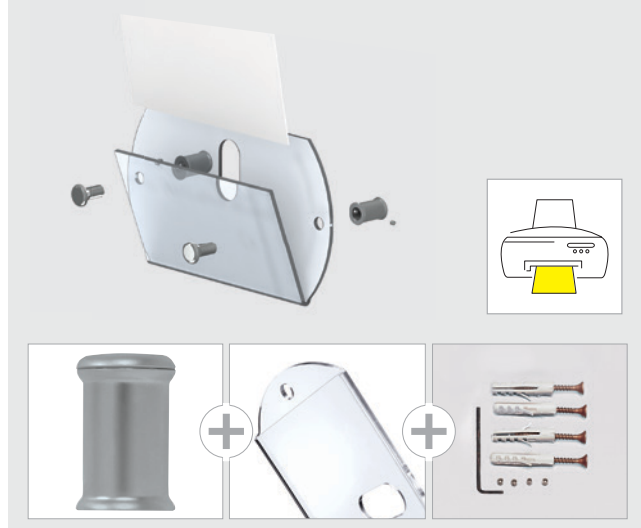

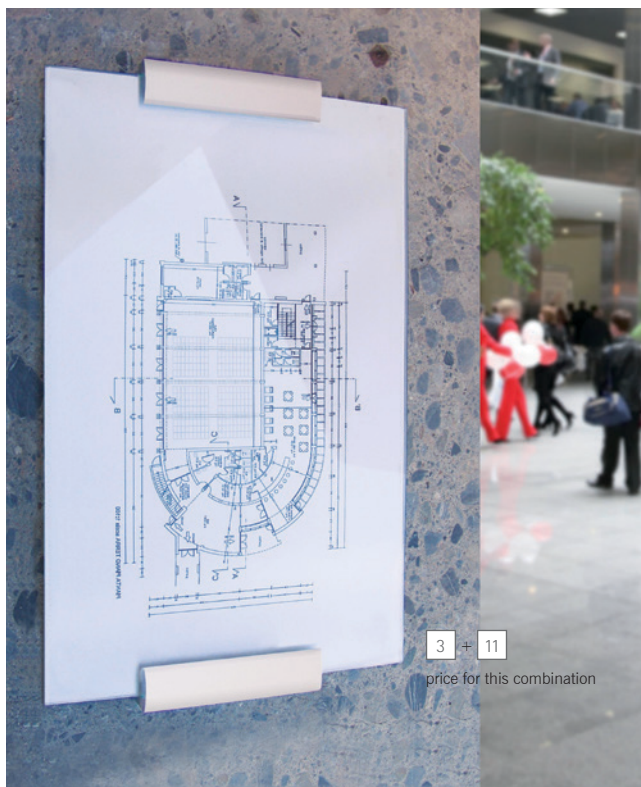

3 + 11
price for this combination



clamper

MADE IN EU design by KD

IT elegante sistema ad incastro per pannelli privi di fori. pannelli di spessore diverso potranno essere assicurati senza bisogno di fori. clamper può essere usato in diverse lunghezze, mono o bifacciale, per sistemi a sandwich o per singoli pannelli. abbiamo selezionato per voi pannelli di vetro temperato nei formati più comuni.

DE elegantes klemmsystem für panele ohne bohrung. panele diverser stärke werden ohne bohrung sicher befestigt. clamper kann ein- oder zweiseitig, im sandwichsystem oder mit einzelpaneelen verwenden. temperierte gläser gängiger grössen haben wir für sie zusammengestellt.

EN elegant clamp system for panels without holes. panels of different thicknesses are safely fastened without holes. you can use clamper in different lengths, on one or two sides, as sandwich system or with single panels. we provide you also with tempered glass panels in the most common sizes.



ulteriori informazioni pag.
mehr details s.
more information p.

372

information

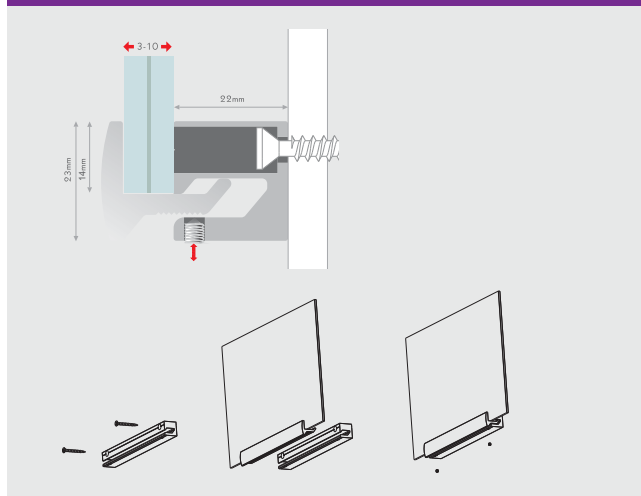

clamper

1	FCL60	clamper 60mm,1pc
2	FCL100	clamper 100mm,1pc
3	FCL200	clamper 200mm,1pc
4	FCL300	clamper 300mm,1pc
5	FCL400	clamper 400mm,1pc
6	FCL600	clamper 600mm,1pc
7	FCL900	clamper 900mm,1pc
8	FCL2000	clamper 2000mm,1pc
9	FCL150150VE	glass 150x150x4mm,1pc
10	FCL150300VE	glass 150x300x4mm,1pc
11	FCL300450VE	glass 300x450x4mm,1pc
12	FCL450600VE	glass 450x600x4mm,1pc



1
luxboard 300x450



luxboard

MADE IN EU design by KD

IT nobile: lavagna in vetro. pannello di vetro temperato 6mm di spessore, retro serigrafato in bianco, fissaggio con fisso clampler in alluminio anodizzato color argento. potete attaccare i vostri messaggi su luxboard oppure scrivere direttamente sulla lavagna con pennarelli cancellabili a secco. un vero e proprio articolo di design per un'atmosfera ricercata in una lobby, in un club, in negozio, in ufficio o anche a casa.

DE edel: wandtafel aus glas. temperiertes 6mm starkes glas-paneel, rückseitig weisser siebdruck, befestigung mit fisso clampler aus silber eloxiertem aluminium. luxboard kann beklebt oder mit trocken abwischbaren stiften beschriftet werden. ein echtes designerstück für cooles ambiente in lobby, bar, lounge, club, shop-, office- oder homebereich.

EN noble: whiteboard in glass. tempered 6mm strong glass panel, rear side with white silkscreen print, mounting with fisso clampler made of silver anodized aluminium. on luxboard you can paste your messages or write them with non permanent whiteboard markers. a real designer's item for cool ambience in the lobby, bar, lounge, club, shop, office or at home.

information

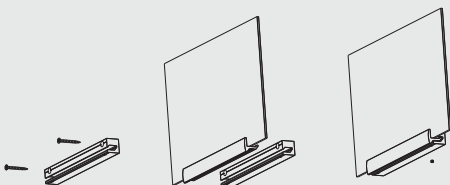

luxboard

1	LXB300450 *	luxboard 300x450mm, 1pc
2	LXB600450 *	luxboard 450x600mm, 1pc
3	LXB900600 *	luxboard 600x900mm, 1pc

* fino ad esaurimento scorte | solange vorrat reicht | while stock last



3
clipper 700x500mm

clipper

MADE IN EU design by KD



IT cornici velocemente intercambiabili per sistemi a parete, su cavo o su astine. per poster, manifesti, immagini, foto o per qualsiasi altro tipo di informazione. alluminio anodizzato, robusto retro in materiale plastico, foglio protettivo trasparente resistente ai raggi uv e antiriflesso. dotate di fori, per montaggio a parete. anche idoneo per il fissaggio su cavi di acciaio o astine, basta forare la cornice lateralmente. semplice ed efficace. disponibili nei formati piu comuni.

DE schnellwechsel-rahmen für wand, seilspann- und stangensysteme. für poster, werbeplakate, bilder, fotos oder andere infos. silbereloxiertes aluminium, stabile kunststoffrückwand, plakatabdeckung aus uv-beständiger und reflektionsmindernder schutzfolie. mit lochbohrungen für einfache wandmontage. auch für befestigung auf stahlseil oder stangensystem geeignet, einfach entsprechende lochbohrungen seitlich selbst anbringen. in allen gängigen formaten.

EN quick exchange frame for wall, suspension systems on cable or bars. for posters, pictures, fotos, prints, ads or other information. silver anodized aluminium frame, stable synthetic back, front protection made of uv-resistant and non-reflecting lamination sheet. with holes for easy mounting on walls. can also be mounted with cables or bars, just make the needed holes at the frames side profiles. available in the most common sizes.



information

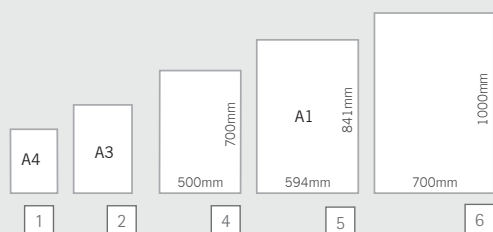

clipper

1	YCLA4	clipper A4, 1pc
2	YCLA3	clipper A3, 1pc
3	YCL700500	clipper 700x500mm, 1pc
4	YCLA1	clipper A1, 1pc
5	YCL1000700	clipper 700x1000mm, 1pc

clippinfo

MADE IN EU design by KD



1
clippinfo 700x500mm



IT le cornici a scatto clipper si incontrano con il nostro profilo multifunzionale soistes. il profilo in alluminio anodizzato color argento poggia sulla robusta base con rivestimento di protezione in abs e sostiene stabilmente la cornice di alluminio anodizzato color argento, dotata di retro in materiale sintetico e frontale protettivo trasparente resistente ai raggi UV e antiriflesso.

DE schnellwechselrahmen clipper meets multitalent soistes: silbereloxiertes aluminiumprofil auf rundbasis mit abs-trittschutz ring gibt sicheren stand für die clipper-rahmen aus silbereloxiertem aluminium, mit stabiler kunststoffrückwand und plakatabeckung aus uv-beständiger und reflektionsmindernder schutzfolie.

EN quickly interchangeable frame clipper meets all-rounder soistes: silver anodised aluminium extrusion on a base with abs protection gives a stable stand to the silver anodised aluminium frame, with a plastic rear and a transparent poster cover sheet. uv-resistant and reflection proof.



information

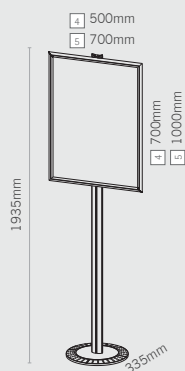

clippinfo

1	SOCI700500	clippinfo 700x500mm, 1pc
2	SOCI1000700	clippinfo 1000x700mm, 1pc

**NEW
PRODUCT**



lumo clipper A3

lumo clipper

MADE IN EU controlled by KD

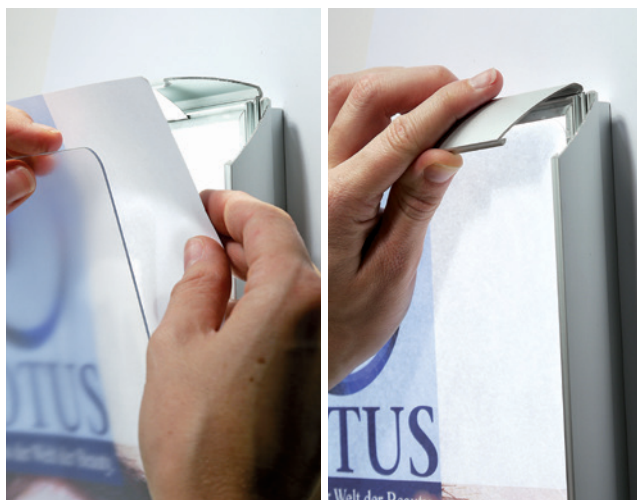

IT il nostro lumo clipper è composto da una cornice a scatto completa di retroilluminazione a led. il foglio protettivo, in materiale sintetico trasparente a bassa riflessione, è resistente ai raggi UV. la cornice a scatto realizzata in alluminio anodizzato è una soluzione elegante, che mette in risalto la linea moderna del prodotto. questo sistema facilita la sostituzione di informazioni in modo veloce e semplice.

DE unser lumo clipper ist ein klapprahmensystem mit hinterleuchtung durch LED. die abdeckfolie ist aus uv-beständigem und reflektionsarmen transparentem kunststoff. der klapprahmen in elegantem silbereloxiertem aluminium unterstreicht den modernen look. ihre info können sie schnell und einfach jederzeit wechseln.

EN our lumo clipper is a clip frame system with back lighting by LED. the transparent cover is uv-resistant and non reflective. the clip frame made of silver anodized aluminium emphasizes the elegant look. your information is changed quickly and easily at anytime.



information

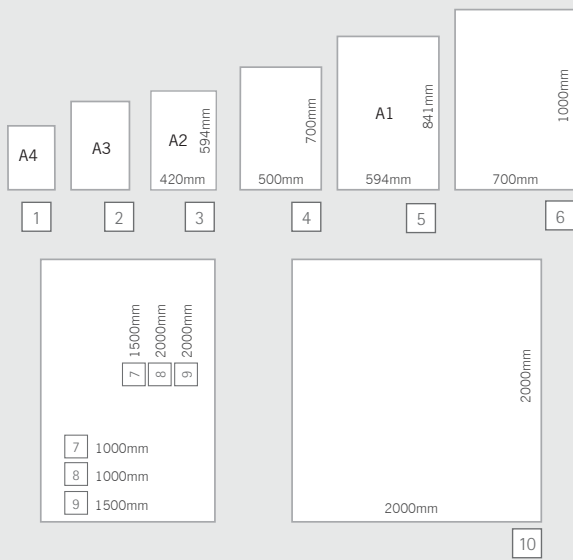

lumo clipper

1	LCLA4	lumo clipper A4, 1pc
2	LCLA3	lumo clipper A3, 1pc
3	LCLA2	lumo clipper A2, 1pc
4	LCL700500	lumo clipper 700x500mm, 1pc
5	LCLA1	lumo clipper A1, 1pc
6	LCL7001000	lumo clipper 700x1000mm, 1pc
7	LCL10001500	lumo clipper 1000x1500mm, 1pc
8	LCL10002000	lumo clipper 1000x2000mm, 1pc
9	LCL15002000	lumo clipper 1500x2000mm, 1pc
10	LCL20002000	lumo clipper 2000x2000mm, 1pc



9
lumo clipper 1500x2000mm

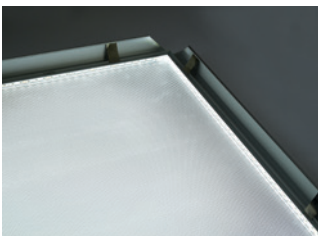

cornice a scatto con retroilluminazione a led

Klapprahmen system mit led hinterleuchtung

clip frame system with led back lighting

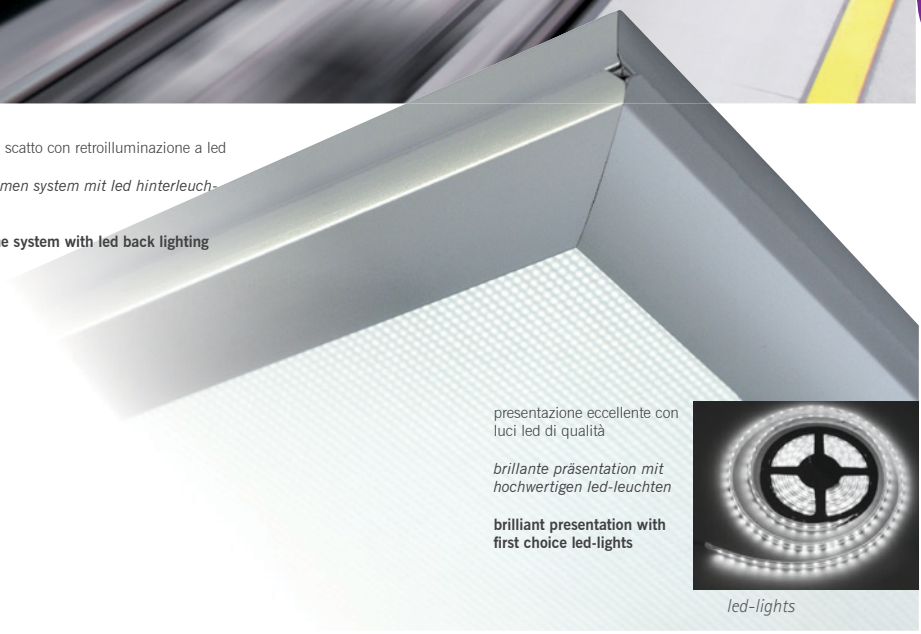
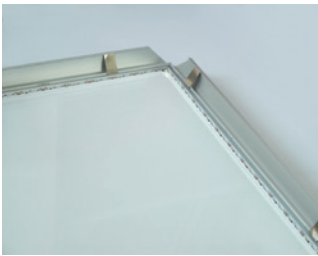

presentazione eccellente con luci led di qualità

brillante präsentation mit hochwertigen led-leuchten

brilliant presentation with first choice led-lights



led-lights



1
lumo A4

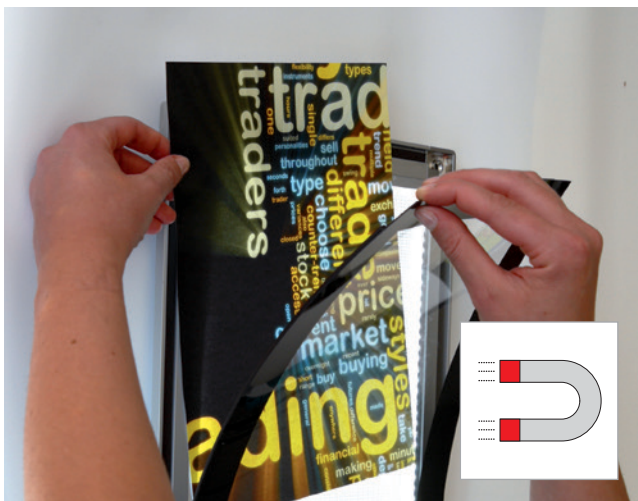

information

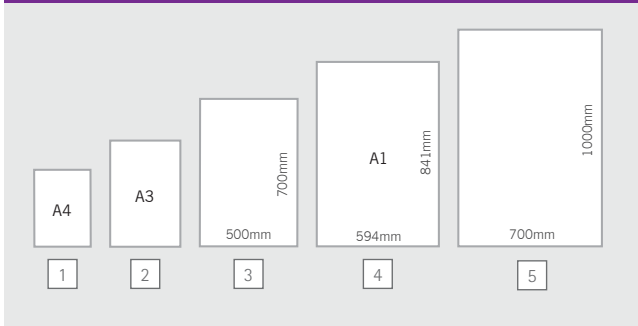

lumo

MADE IN EU design by KD

IT lumo è il pannello illuminato da parete di prima classe. il pannello in acrilico di 8 mm al contrario dei pannelli serigrafati è inciso e questo garantisce una regolare ed uniforme illuminazione anche nei formati più grandi. i led che utilizziamo per lumo sono di alta qualità e garantiscono una lunga durata d'impiego. il foglio protettivo flessibile in policarbonato è resistente ai raggi uv e grazie al sistema di chiusura magnetica può essere sollevato in parte o completamente, rendendo così il cambio del manifesto rapido e semplice. il bordo laterale di 30mm serigrafato di colore nero è discreto e nel contempo elegante.

DE lumo für die wandmontage ist ein extra flaches leuchtpaneel der sonderklasse. das 8mm starke acryl ist graviert und somit garantiert es im gegensatz zum siebdruck die gleichmässige und vollständige ausleuchtung der gesamten fläche. die hochwertigen LED haben eine sehr lange lebensdauer. die transparente und flexible folie aus polycarbonat ist uv-beständig. durch den magnetverschluss ist sie teilweise oder auch komplett abnehmbar und der austausch der information ist damit jederzeit schnell und unkompliziert möglich. das schwarze siebdruck passepartout ist mit geringen 30mm sehr dezent gehalten.

EN lumo für die wandmontage ist ein extra flaches leuchtpaneel der sonderklasse. das 8mm starke acryl ist graviert und somit garantiert es im gegensatz zum siebdruck die gleichmässige und vollständige ausleuchtung der gesamten fläche. die hochwertigen LED haben eine sehr lange lebensdauer. die transparente und flexible folie aus polycarbonat ist uv-beständig. durch den magnetverschluss ist sie teilweise oder auch komplett abnehmbar und der austausch der information ist damit jederzeit schnell und unkompliziert möglich. das schwarze siebdruck passepartout ist mit geringen 30mm sehr dezent gehalten.

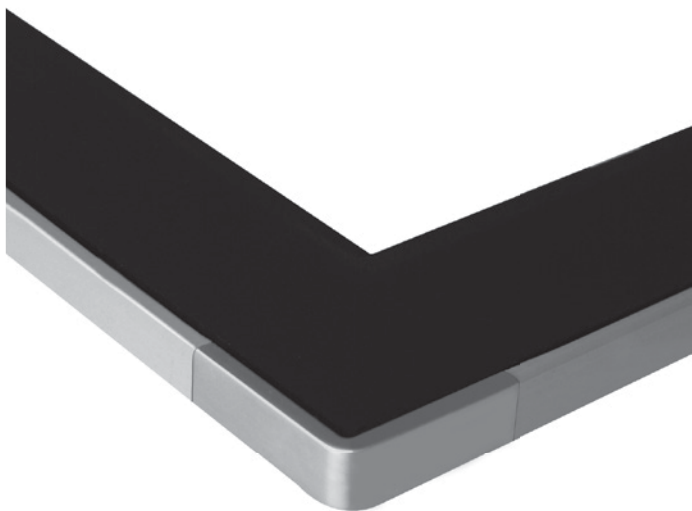

lumo



1	LUMORA4	lumo A4, 1pc	
2	LUMORA3	lumo A3, 1pc	
3	LUMOR700500	lumo 700x500mm, 1pc	
4	LUMORA1	lumo A1, 1pc	
5	LUMOR1000700	lumo 1000x700mm, 1pc	



3
lumo 700x500mm

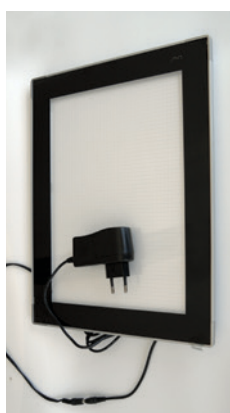

cornice: alluminio anodizzato color argento,
angoli in zamac color argento

rahmen: silber eloxiertes aluminium, ver-
silberte eckverbinder aus metalldruckguss

frame: silver anodised aluminium profile,
corner connectors made of zamac in silver

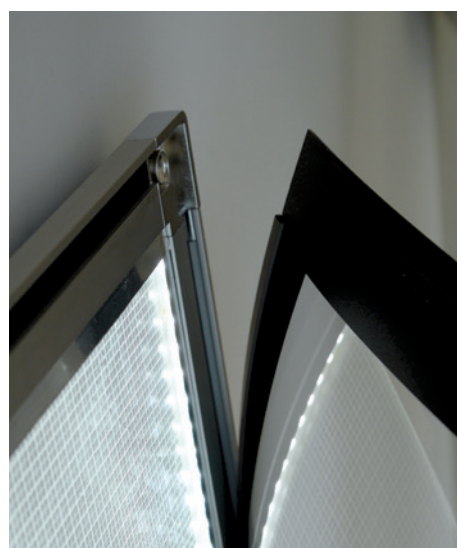
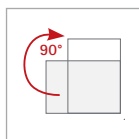

presentazione eccellente con
luci led di qualità

brillante präsentation mit
hochwertigen led-leuchten

brilliant presentation with
first choice led-lights



led-lights

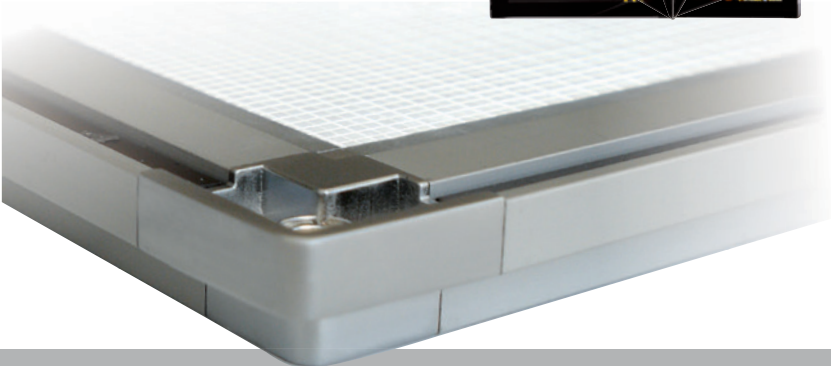

**NEW
PRODUCT**



prints and banners not included

lumo twist

MADE IN EU design by KD

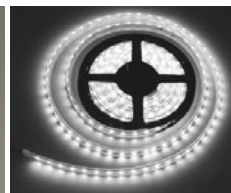

led-lights

presentazione eccellente con luci led di qualità

brillante präsentation mit hochwertigen led-leuchten

brilliant presentation with first choice led-lights

IT una soluzione elegante ed astuta, che combina un pannello luminoso con una stampa personalizzata su dibond o su banner in tessuto: gli elementi del pannello luminoso lumo sono ruotabili di 360° in passi di 22,5°. sono disponibili due misure per le cornici con due rispettivi moduli abbinabili. sul retro è possibile montare banner in tessuto o pannelli compositi. l'informazione nei pannelli luminosi lumo è facilmente sostituibile, grazie alla cornice frontale magnetica. lumo twist: per le vostre presentazioni di grande effetto.

DE eine elegante und pfiffige kombination aus leuchtpaneel und personalisierung mit druck auf dibond oder textilem banner: die elemente mit den leuchtpaneelen der lumo serie lassen sich um 360° drehen und rasten in 22,5° schritten ein. zur auswahl haben wir zwei grössen an rahmenstrukturen und je zwei module, die sie miteinander kombinieren können. auf der rückseite können sie entweder textile banner oder verbundpaneele montieren. die info in den lumo leuchtpaneelen wird dank des magnetisch befestigten passepartouts schnell gewechselt. der lumo twist: ein strahlender auftritt für ihre präsentation.

EN an elegant and smart combination of light panel and customization with print on dibond or textile banners: the structure with the light panels of the lumo series can be turned 360° and stop every 22,5°. for your choice we offer two sizes of frame structures and two elements that can be combined with each other. on the rear side of the structure you can mount either textile banners or composite panels. thanks to magnets the cover of the lumo light panels can be removed easily, allowing you to exchange the information quickly. the lumo twist: an illustrious appearance for your presentations.

information

alluminio anodizzato color argento, connettori cromati color argento satinato. al momento dell'ordine si prega di indicare la posizione dei moduli per l'installazione dei cavi.

silber eloxiertes aluminium, silbermatt verchromte verbindler. bei bestellung position der module angeben für kabelverlegung

anodized aluminium, silver matt plated connectors. when ordering, indicate position of panels for correct cable settings

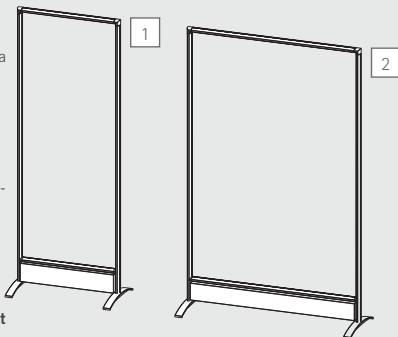

alluminio anodizzato color argento, connettori color argento satinato. al momento dell'ordine si prega di indicare la posizione dei moduli per l'installazione dei cavi.

lumo leuchtpaneel auf mattschwarzem alu-verbund-paneel, (rückseitig option für stoffbanner oder verbundpaneel - nicht im lieferumfang enthalten)

lumo light panel on matt black aluminium-composite panel. (rear part option for textile banner or panel - not included)

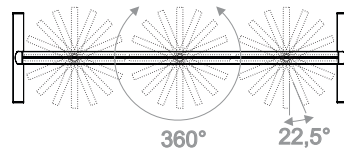
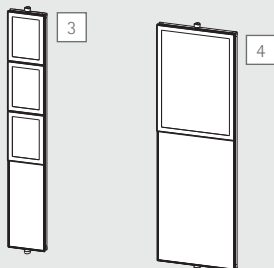

lumo twist



1	SOCL2050720	lumo twist structure small, 1pc
2	SOCL20501570	lumo twist structure big, 1pc
3	SOCL3A4	lumo twist 3x4, 1pc
4	SOCL700500	lumo twist 700x500mm, 1pc



2 +2x 3 +1x 4

lumo twist

prints and banners not included

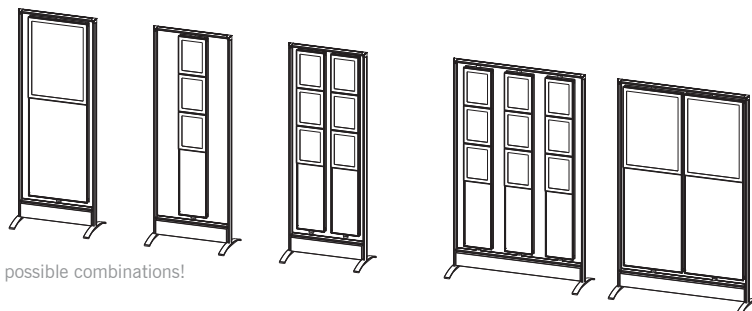

possible combinations!



la cornice frontale magnetica rende la sostituzione delle vostre informazioni nei moduli luminosi semplice e facile

magnethalterungen im passepartout machen den austausch ihrer info in den leuchtmodulen einfach und schnell

magnetic supports in the cover foil make the exchange of your information in the light panels easy and quick



banners not included

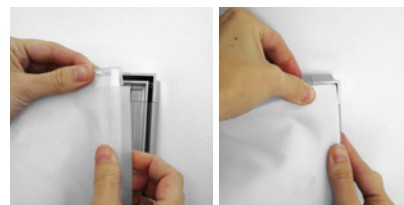

i banner in tessuto possono essere applicati sul retro in modo semplice e veloce, senza l' utilizzo di utensili

textile banner können auf der rückseite einfach und schnell ohne werkzeug eingesetzt und ausgetauscht werden

fabric banners can be easily attached and exchanged at anytime without the need for tools



3
magnedoor A1



magnedoor®

MADE IN EU design by KD

IT cornici con chiusura magnetica. alluminio anodizzato, robusto retro in materiale plastico, bordi stampati di color grigio-argento, foglio protettivo in policarbonato flessibile, fissato al profilo con colla sul lato inferiore. un robusto listello magnetico rende possibile il fissaggio del foglio protettivo alla struttura. cambiare informazioni é quindi facile e veloce; adatto a montaggio orizzontale e verticale.

DE schnellwechselrahmen mit magnetverschluss. silber eloxierte aluminiumrahmenprofile, stabile kunststoffrückwand. plakatabdeckung aus flexibler polycarbonat-folie, am rand mit silbergrauem siebdruck, einseitig verklebt. eine starke magnetleiste hält die flexible folie sicher fest. info-wechsel schnell und einfach, für horizontale oder vertikale montage.

EN quick exchange frame with magnetic closing. silver anodized aluminium frame, stable synthetic back, front protection made of flexible polycarbonate foil, with silver grey silkscreen printed border, fixed with glue on one side. a strong magnetic strip holds the flexible foil firmly in place. information exchange is quick and easy, for mounting horizontally and vertically.

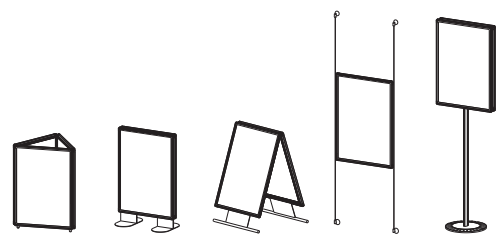
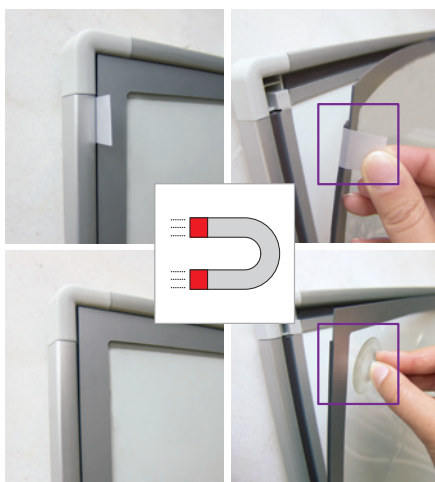

information

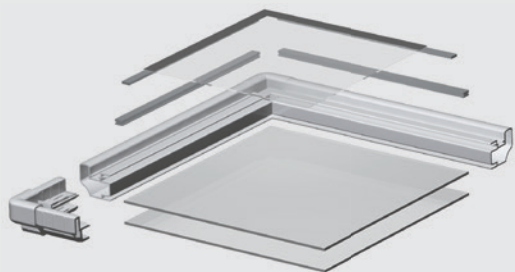

magnedoor

1	MADA4	magnedoor A4, 1pc
2	MADA3	magnedoor A3, 1pc
3	MADA1	magnedoor A1, 1pc
4	MAD700500	magnedoor 700x500mm, 1pc
5	MAD1000700	magnedoor 1000x700mm, 1pc
6	MAD14001000	magnedoor 1400x1000mm, 1pc



4
magnedoor slim 700x500mm



magnedoor® slim

MADE IN EU design by KD

IT cornici con chiusura magnetica, restyling per un aspetto più snello e leggero. alluminio anodizzato, robusto retro in materiale plastico, bordi stampati di color grigio-argento, foglio protettivo in pvc flessibile anti-riflesso completamente rimovibile. un robusto listello magnetico rende possibile il fissaggio del foglio protettivo alla struttura. cambiare informazioni è quindi facile e veloce; adatto a montaggio orizzontale e verticale.

DE schnellwechselrahmen mit magnetverschluss, restyle mit schlanker optik und weniger gewicht. silber eloxierte aluminiumrahmenprofile, stabile kunststoffrückwand. komplett abnehmbare plakatabdeckung aus flexibler nicht spiegelnder pvc-folie, am rand mit silbergrauem siebdruck. eine starke magnetleiste hält die flexible folie sicher fest. info-wechsel schnell und einfach, für horizontale und vertikale montage.

EN quick exchange frame with magnetic closing, restyled with a lean look and less weight. silver anodized aluminium frame, stable synthetic back, front protection made of flexible non reflective pvc foil, with silver grey silkscreen printed border. the flexible foil is completely removable and a strong magnetic strip holds it firmly in place. information exchange is quick and easy, for mounting horizontally and vertically.



cornice: alluminio anodizzato color argento, angoli in zamac color argento

rahmen: silber eloxiertes aluminium, versilberte eckverbinder aus metall-druckguss

frame: silver anodised aluminium profile, corner connectors made of zamac in silver

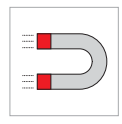

ulteriori informazioni pag. 236
mehr details s. 236
more information p. 236

magnedoor slim

1	MASA4	magnedoor slim A4, 1pc
2	MASA3	magnedoor slim A3, 1pc
3	MASA2	magnedoor slim A2, 1pc
4	MAS700500	magnedoor slim 700x500mm, 1pc
5	MASA1	magnedoor slim A1, 1pc
6	MAS1000700	magnedoor slim 1000x700mm, 1pc



2

mago magnedoor 4xA4v

mago magnedoor

MADE IN EU design by KD

IT con mago il sistema magnedoor si trasforma in una vera e propria bacheca da parete con foglio protettivo in policarbonato flessibile e chiusura magnetica per proteggere le vostre informazioni, tra le altre cose, contro l'acqua e l'umidità; mago è quindi anche adatto ad ambienti esterni protetti. il retro-pannello è magnetico e scrivibile.

DE das magnedoor system als schaukasten mago mit flexibler polycarbonat-folie und magnetverschluss schützt ihre info vor spritzwasser und feuchtigkeit und ist daher durchaus für geschützte aussenbereiche geeignet. die rückwand ist magnetisch und kann wie ein whiteboard mit abwischbaren stiften beschrieben werden.

EN the magnedoor system as a wall cabinet mago with a protective sheet in flexible polycarbonate and a magnetic closing system protects your information from drops of water and humidity. therefore it is also adapt for sheltered outdoor areas. the rear panel is magnetic and is writable like a whiteboard with non permanent markers.



cornice in alluminio anodizzato con protettivo in policarbonato flessibile e chiusura magnetica, retro-pannello magnetico e scrivibile.

silber eloxierter aluminium profilrahmen mit magnetverschluss, flexible polycarbonat-folie, rück-wand magnetisch und beschreibbar

silver anodised aluminium frame with magnetic lock, flexible polycarbonate cover, rear panel magnetic and writable

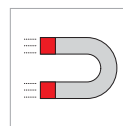

mago magnedoor

1	MAGO2A4V	mago magnedoor 2xA4v, outersize 542x392mm, 1pc
2	MAGO4A4V	mago magnedoor 4xA4v outersize 542x742mm, 1pc
3	MAGO6A4V	mago magnedoor 6xA4v outersize 742x742mm, 1pc

cartbox

MADE IN EU design by KD

IT cassetta espositiva e per deposito chiavi. alluminio anodizzato color argento, pannello in acciaio laminato bianco, piastra in plastica, chiusura a cilindro con 2 chiavi e materiale per il montaggio inclusi. lavagna scrivibile con pennarelli non indelebili, adatta per magneti. numerazione e ganci per 45 chiavi.

DE schau- und schlüsselkasten. silber eloxiertes aluminium, weissbeschichtete stahlwand, kunststoffscheibe, zylinderschloss mit 2 schlüsseln und montage-material inklusive. mit nicht permanenten whiteboard markern beschreibbar, für magnete geeignet. schlüsselkasten mit nummerierung und haken für 45 schlüssel.

EN display and key cabinet. silver anodized aluminium frame, white coated steel panel, plastic window, cylinder lock with 2 keys and mounting material inclusive. writeable panel for non permanent markers, suitable for magnets. key cabinet with numbering and hooks for up to 45 keys.



4
display cabinet 969x775mm



5
key cabinet



information

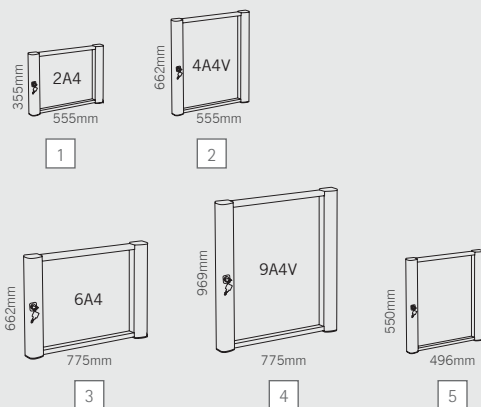

cartbox

1	CB2A4	display cabinet outsize 355x555mm, 1pc
2	CB4A4V	display cabinet outsize 662x555mm, 1pc
3	CB6A4	display cabinet outsize 662x775mm, 1pc
4	CB9A4V	display cabinet outsize 969x775mm, 1pc
5	CB45	key cabinet, 45 keys, outsize 550x496mm, 1pc

**NEW
PRODUCT**

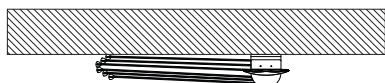

due punti di rotazione: quando l'espositore è chiuso, tutti i poster rimangono adiacenti alla parete

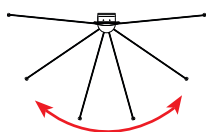

2 drehpunkte: geschlossen liegen alle poster bündig auf kante an der wand

2 pivot points: closed all the posters align perfectly end-to-end

information

supporto a parete con tasca A5, alluminio anodizzato color argento

wandhalter mit A5 tasche, silber eloxiertes aluminium

wall support with A5 display, silver anodized aluminium

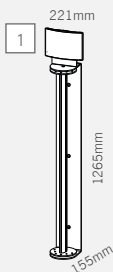

supporto per poster in acrilico trasparente, cornice in alluminio anodizzato color argento

posterhalter transparentes acryl, rahmen silber eloxiertes aluminium

poster support transparent acrylic, frame made of silver anodized aluminium

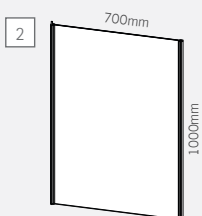

maxilibro

MADE IN EU design by KD

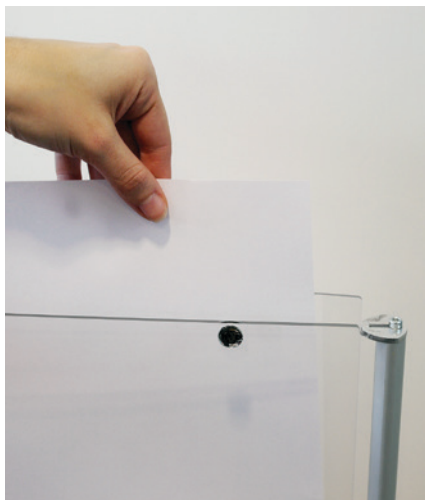

le tasche porta poster possono essere facilmente aperte dall'alto, permettendo così l'inserimento d'informazioni; chiusura magnetica

postertaschen können oben einfach geöffnet werden zum einlegen der info, mit magnetverschluss

poster pockets can be opened easily on top for information, magnetic lock

IT supporto per maxi poster da parete: al pratico supporto a parete è possibile agganciare fino a sei tasche porta poster bifacciali in acrilico trasparente, in modo da poter sfogliare comodamente le informazioni ivi contenute. maxilibro è dotato di due punti di rotazione, che mantengono quindi i poster perfettamente allineati e con la giusta angolazione. tutti gli elementi sono realizzati in alluminio di alta qualità color argento satinato e acrilico trasparente. la tasca pixquick A5 sull'espositore rende possibile un'ulteriore personalizzazione del prodotto. tutte le tasche porta poster sono facili da agganciare e sganciare dal supporto a muro senza l'utilizzo di utensili.

DE grossformatiger posterhalter für die wand: bis zu sechs doppelseitige postertaschen aus transparentem acryl können sie in die praktische wandhalterung enhängen, um darin zu blättern. maxilibro verfügt über 2 drehpunkte, so liegen die poster immer im richtigen winkel zueinander. alle materialien sind aus hochwertigem silbermatt veredeltem aluminium und transparentem acrylglas. personalisiert kann der wandhalter mit einem A5 einleger in der integrierten pixquick tasche. alle posterhalter können ohne werkzeug jederzeit ganz einfach in den wandhalter ein- und ausgehängt werden.

EN lager format poster display for the wall: up to six double side poster pockets made of transparent acrylic can be attached to the clever wall support. maxilibro has 2 pivot points, thus the posters are always in a correct angle to each other. all materials are made of silver anodized aluminium and transparent acrylic. you can customize the wall support with a print in A5 thanks to the integrated pixquick support. all poster pockets can be easily attached and exchanged without any tools anytime.

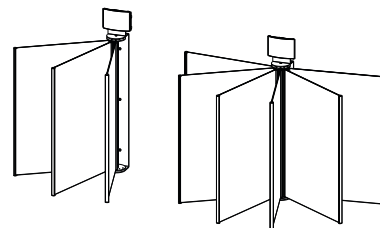

can hold up to six double-sided poster pockets

maxilibro ¹⁾

1	MLS1050140	maxilibro structure, 1pc
2	MLB1000700	maxilibro 1000x700mm, 1pc

1) in vendita da marzo 2013 | auslieferung ab märz 2013 | on sale from march 2013



1 +6x 2
 maxilibro structure +
 6x maxilibro1000x700mm

framframe floor

 MADE IN EU design by KD

IT framframe floor può essere utilizzato con banner in tessuto mono- o bifacciali per creare espositori da terra autoportanti. i banner in tessuto sono sostituibili in modo veloce e in qualsiasi momento senza bisogno di smontare la struttura e ricorrere ad utensili. funge da parete divisoria, elemento decorativo o spazio pubblicitario. frontalmente sono visibili solo 2mm della cornice: i motivi rappresentati danno quindi l'idea di essere sospesi – la cornice passa in secondo piano.

DE framframe floor können sie ein- oder beidseitig mit textilen bannern für dekorative freistehende bodendisplays verwenden. die bedruckten stoffbanner können sie jederzeit schnell, ohne demontage und ohne werkzeug austauschen. ideal als raumteiler, dekoratives element oder werbefläche. frontal gesehen sind nur noch 2mm rand von der struktur sichtbar: die motive wirken autonom - das system hält sich diskret im hintergrund.

EN framframe floor you can use single- or double side with fabric banner for decorative freestanding floor displays. the printed banners can be exchanged quickly anytime without any tools. perfect as a partition, decorative element or advertising space. from the head-on view you see only 2mm of the structure: the images act for themselves - the framframe system steps back discreetly.



print not included

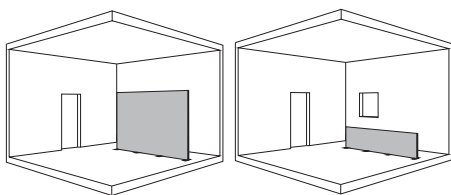

information

profili in alluminio anodizzato color argento, angoli in metallo pressofuso color argento opaco.

silber eloxierte aluminiumprofile, silbermatt veredelte metall-druckguss-eckverbinder

silver anodized aluminium profiles, silver matt plated zamac edge connectors

1-6

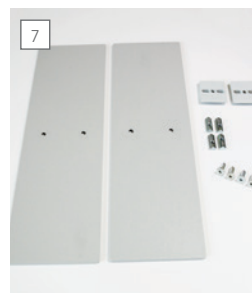
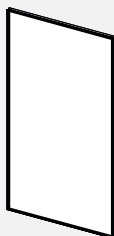

floor base

base di appoggio in metallo verniciato color argento
bodenplatte aus silberlackiertem metall
floor plate made of silver varnished metal



ulteriori informazioni pag.
mehr details s.
more information p.

144

framframe floor

1	FFR1500500	framframe 1500x500mm, 1pc
2	FFR2000800	framframe 2000x800mm, 1pc
3	FFR20001000	framframe 2000x1000mm, 1pc
4	FFR25001500	framframe 2500x1500mm, 1pc
5	FFR25002500	framframe 2500x2500mm, 1pc
6	FFR30002500	framframe 3000x2500mm, 1pc
7	FFRB300100	framframe base, 2pcs



3 digipresso silver 400mm

panel not included



1-3

profilo in alluminio anodizzato con protezione anti-scivolo, vite a testa zigrinata

Klemmprofil aus eloxiertem Aluminium, mit anti-rutsch schutz und rändelschraube

clamping profile made of anodized aluminium with anti-slip protection and knurled head screw



4

tappi laterali abs nero, set con 4 pz
seitenabdeckkappen abs schwarz, set mit 4 stück

lateral cover caps abs black, set with 4 pcs

ulteriori informazioni pag.
mehr details s.
more information p.

176

digipresso

MADE IN EU design by KD

IT digipresso è straordinario: grazie a lui i vostri pannelli potranno diventare indicatori di direzione, banner pubblicitari, divisori di spazio o elementi decorativi per interni ed esterni. utilizzate a piacere la base in alluminio con pannelli di 30 mm: grazie alla sua speciale conformazione, pannelli di qualsiasi materiale rimangono stabili e dritti sulla base. digipresso si apre e si chiude grazie ad una vite a testa zigrinata che tiene uniti i 2 profili. i feltrini compresi nella confezione proteggono il pannello e rendono la base anti-scivolo e più stabile. nella versione in alluminio anodizzato color argento digipresso è disponibile già montato nei formati più comuni. il programma di accessori comprende tappi laterali in colore nero e 2 versioni laccate in nero rispettivamente di 100mm e 200mm (con tappi laterali neri).

DE eine tolle sache: mit ihrem paneel wird digipresso zum hinweisschild, werbebanner, raumteiler oder dekorativem element im innen- und aussenbereich. kombinieren sie das aluminiumprofil mit paneelen der stärke von 30mm. unterschiedlichste materialien werden gleichmässig eingespannt. geöffnet und geschlossen wird digipresso mittels rändelschraube. integrierte gummilitzen schützen ihr panel und geben rutschfesten stand. in silber eloxierter ausführung sind die gängigsten längen vormontiert. im zubehör programm finden sie schwarze seitenabdeckkappen. ausserdem im programm: 100mm bzw. 200mm mit schwarzer pulverbeschichtung und abdeckkappen.

EN digipresso is really great: together with your panel digipresso becomes a signpost, an advertising banner, a partition wall or a decorative element in interior and exterior areas. combine the anodized aluminium profile with panel from 30mm. the special construction gives digipresso maximum flexibility: materials are shut in safely by digipresso. open and close the profile easily with the knurled head screw. integrated rubber laces protect your panel and act as anti-slip pads as well. the most standard lengths come already mounted. black side caps can be ordered as an accessory. furthermore we provide you with 100m and 200mm lengths black powder coated and with side caps.

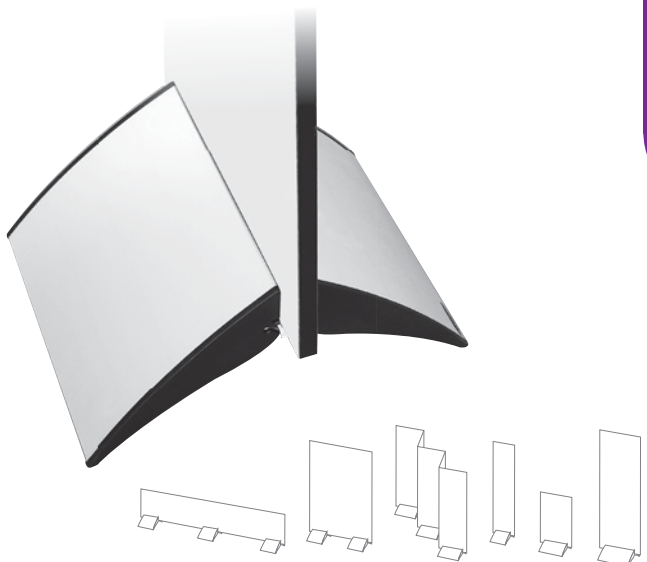

digipresso

1	PT235	digipresso silver 235mm, 1pc	
2	PT300	digipresso silver 300mm, 1pc	
3	PT400	digipresso silver 400mm, 1pc	
4	PTAKSZ	cover caps black, 4 pcs	



print not included

1
pylo 1900x800mm

pylo

MADE IN EU design by KD

IT con signwalk siete sempre in movimento: il design intelligente consente di unire 2 pannelli, per comporre un elegante display per interni ed esterni. signwalk può essere utilizzato anche per trasportare comodamente tutta la struttura. quando non lo utilizzate, chiudete i pannelli, in modo che i lati stampati vadano a trovarsi all'interno – per un trasporto o uno stoccaggio a prova di graffio. forniamo la struttura e anche i pannelli forex in color bianco.

DE mit signwalk jederzeit mobil: das clevere design verbindet 2 paneele zum kundenstopper für in- und outdoor. die verbindungsstange ist zugleich praktischer tragegriff. für transport und lagerung klappen sie beide paneele auf den bedruckten seiten bündig zusammen, so bleibt das decor kratzgeschützt. wir bieten ihnen die struktur sowie passende forex paneele in weiss.

EN with signwalk you are mobile: the clever design turns 2 panels into a display for in- and outdoor. the connector bar is a convenient carrying handle. for transport and storage just fold signwalk with the images inside and it will be protected against scratches. we offer you the structure and matching white forex panels as well.

ulteriori informazioni pag.
mehr details s.
more information p.

180

pylo

1 SOPY1900800

pylo 1905x800mm, 1pc



print not included

2
pylo poster 1000x700

pylo poster

MADE IN EU design by KD

IT pylo poster è il totem autoportante per la presentazione di informazioni facilmente sostituibili grazie alle tasche portaposter disponibili in tre diverse misure e munite di protezione trasparente flessibile in policarbonato resistente ai raggi ultravioletti.

DE freistehendes totem pylo poster für flexible informationpräsentation: mit beidseitigen poster-taschen erhältlich für drei gängige plakatgrößen. ausführung wie pylo mit flexibler coverfolie aus uv-beständigem polycarbonat.

EN freestanding totem pylo poster for flexible information presentations: with poster pockets on both sides in the most common poster sizes. design and materials like pylo plus a flexible cover sheet made of uv-resistant polycarbonate.



facile e rapida apertura della custodia protettiva grazie al suo razionale design

schnelles und unkompliziertes öffnen und schliessen der cover folie dank cleverem design

quick and easy opening and closing of the cover sheet thanks to our clever design.

ulteriori informazioni pag.
mehr details s.
more information p.

181

pylo outdoor

2 SO19PP1000700

pylo poster 1000x700mm, 1pc



2
pylo 1900x600mm

print not included

pylo outdoor

MADE IN EU design by KD

IT pylo outdoor è concepito e realizzato appositamente per l'esterno: a seconda della collocazione, la struttura può essere interrata, ancorata o cementata al suolo. i pannelli in alluminio possono essere stampati o decorati con pellicole, prespaziati, vinili, ecc. i pannelli, così come i profili in alluminio anodizzato e gli angoli stampati a pressofusione, sono di alta qualità e duraturi nel tempo. pylo outdoor è disponibile in tre differenti larghezze.

DE pylo outdoor ist speziell für den aussenbereich gemacht: die bodenhalterung wird je nach untergrund angeschraubt oder einzementiert. die aluminium-paneele können sie je nach anforderung bedrucken oder kaschieren. sie sind wie die ebenfalls silber eloxierten aluminiumprofile sowie die veredelten metalldruckguss-ecken hochwertig und langlebig. erhältlich ist der pylo outdoor in drei verschiedenen breiten.

EN pylo outdoor is made especially for outdoor use: the ground sleeve can be fixed with screws or concrete according to your underground. the silver anodized aluminium panels can be printed or laminated. like the silver anodized profiles and the plated zinc aluminium alloy die-cast connectors they are robust and durable. the pylo outdoor is available in three different sizes.



information

profili e pannelli: alluminio anodizzato color argento, angoli in pressofusione, zanche da terra in ferro zincato.

profile und paneele: silber eloxiertes aluminium, verbinder veredelter aluminiumdruckguss, bodenhülse eisen verzinkt

panel and profiles: silver anodized aluminium, connectors plated die cast aluminium alloy, ground sleeve zincated iron

- 1 400mm
- 2 600mm
- 3 800mm

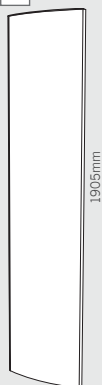
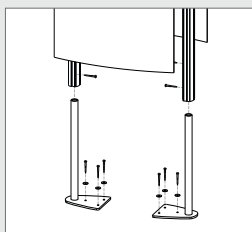

pylo outdoor



1	SOPYO1900400	pylo outdoor 1900x400mm, 1pc	
2	SOPYO1900600	pylo outdoor 1900x600mm, 1pc	
3	SOPYO1900800	pylo outdoor 1900x800mm, 1pc	



2

ipoint 1900x600

print not included

ipoint

MADE IN EU design by KD

IT ipoint é il pratico totem fornito completo di due pannelli in alu bond colore argento e bianco opaco per la stampa digitale, che vi permetterà di creare la vostra grafica sia sul fronte che sul retro. dopo aver effettuato la personalizzazione, incollate i pannelli direttamente ai profili con del silicone o con un'altra colla adatta per quel tipo di materiale. inoltre, a scelta si possono aggiungere ripiani, barre laterali, accessori o altri moduli ipoint dalla linea soistes. chiedeteci e noi saremo sempre a disposizione per darvi ulteriori idee ed informazioni.

DE ipoint liefern wir ihnen mit zwei doppelseitigem alu-verbundpaneel: silber und weiss matt für digitaldruck. sie können so selbst entscheiden wie sie jeweils die vorder- und auch die rückwand ihres ipoint gestalten. nach der personalisierung verkleben sie den ipoint mit silikon oder anderem geeigneten klebstoff direkt am profilrahmen. optional lassen sich ablagen, display bars oder weitere ipoint flächen ergänzen. fragen sie uns, wir beraten sie gerne.

EN ipoint comes complete with two double side aluminium composite panels: satin silver and matt white for digital printing. thus you can freely design front and rear side of your ipoint. after customizing the panels can be simply fixed with silicone or other glue to the profile frame. optionally you can add trays, display bars or further ipoint modules. just ask us, it is our pleasure to provide you with more ideas and further information.



5

connettore per strutture ipoint in zamac color argento

verbinder für ipoint strukturen, versilberter metall druckguss

connector for ipoint structures, silver plated die-cast metal

other possible combinations!

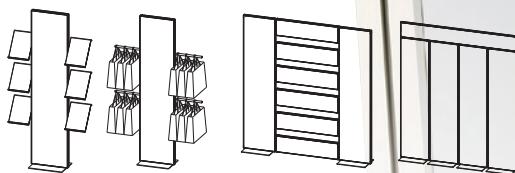

ipoint

1	IP1900400ARW	ipoint 1900x400 silver/white, 1pc	
2	IP1900600ARW	ipoint 1900x600 silver/white, 1pc	
3	IP1400200ARW	ipoint 1410x200 silver/white, 1pc	
4	IP1700200ARW	ipoint 1710x200 silver/white, 1pc	
5	IPTCON	ipoint connector, set 2pcs	



print not included



ipoint media

sign

information

profili in alluminio anodizzato color argento, base metallica verniciata a polvere color argento, pannelli di alluminio composito color bianco opaco e argento, angoli in zamac color argento

silber elox-aluminium profil, basis metall silber pulverbeschichtet, alu-verbundpaneel mattweiss/silber, eckverbinder versilberter metall-druckguss

silver anodized aluminium extrusion, base silver coated metal, aluminium composite panel matt white/silver, edge connectors silver-plated die-cast metal

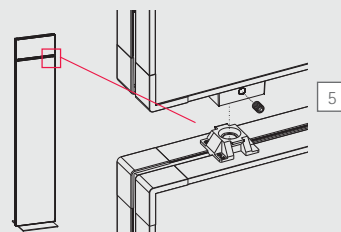
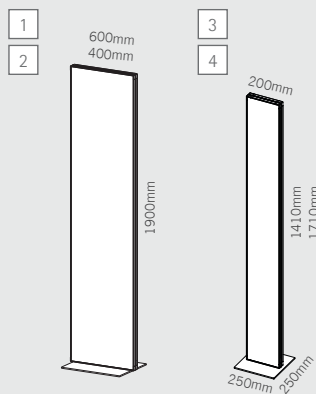

grazie ad ipoint connector il vostro espositore ipoint diventa modulare. basta inserire i dadi nei profili prima di effettuare il montaggio, in modo da poter aggiungere alla struttura tutta una serie di elementi in modo semplice e veloce.

modular wird ihr ipoint mit dem ipoint connector. vor der montage einfach die mutter in die profile stecken und schon können mehrere elemente ganz einfach verbunden werden.

make your ipoint modular with the ipoint connector. just slide in the nuts before mounting and thus you can very easily connect more elements to each other.



1 + 2x 2

signwalk
price for this combination

print not included

signwalk

MADE IN EU design by KD

IT con signwalk siete sempre in movimento: il design intelligente consente di unire 2 pannelli, per comporre un elegante display per interni ed esterni. signwalk può essere utilizzato anche per trasportare comodamente tutta la struttura. quando non lo utilizzate, chiudete i pannelli, in modo che i lati stampati vadano a trovarsi all'interno – per un trasporto o uno stoccaggio a prova di graffio. forniamo la struttura e anche i pannelli forex in color bianco.

DE mit signwalk jederzeit mobil: das clevere design verbindet 2 paneele zum kundenstopper für in- und outdoor. die verbindungsstange ist zugleich praktischer tragegriff. für transport und lagerung klappen sie beide paneele auf den bedruckten seiten bündig zusammen, so bleibt das decor kratzgeschützt. wir bieten ihnen die struktur sowie passende forex paneele in weiss.

EN with signwalk you are mobile: the clever design turns 2 panels into a display for in- and outdoor. the connector bar is a convenient carrying handle. for transport and storage just fold signwalk with the images inside and it will be protected against scratches. we offer you the structure and matching white forex panels as well.

ulteriori informazioni pag.
mehr details s.
more information p.

186

signwalk

1	DSIW338	signwalk, panel excl., 1pc
2	DSIW700500W	panel white 700x500mm, 1pc



3

passboard

print not included

passboard

MADE IN CHINA design by KD

IT passboard diventa in un attimo un pratico display, basta semplicemente inserire il pannello stampato. una soluzione pratica ed economica per l'interno e l'esterno.

DE passboard entfaltet sich im nu zum praktischen präsentier, einfach paneel einschieben fertig. die ökonomische, mobile lösung für innen- wie aussenbereich.

EN passboard folds up in no time at all to a walkway display, simply insert the panel and here you go. an economic and mobile application for in- and outdoor.



ulteriori informazioni pag.
mehr details s.
more information p.

187

passboard

3	DPAB1130	passboard, panel excl., 1pc
---	----------	-----------------------------

**NEW
PRODUCT**



banner not included

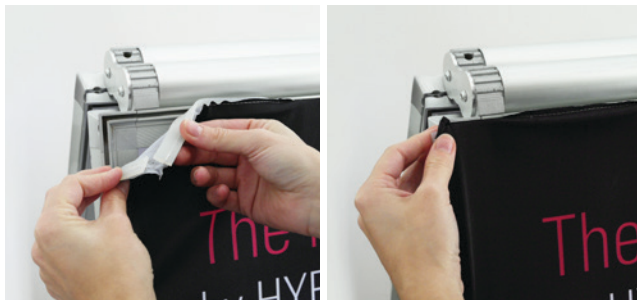

maxiboard

MADE IN EU design by KD

IT un fantastico display per banner in tessuto: è possibile aprire il maxiboard per sostituire velocemente e in qualsiasi momento i banner in tessuto grazie alle strisce in silicone cucite sul banner stesso. tutti gli elementi che lo compongono sono realizzati in alluminio anodizzato di alta qualità in color argento, le parti metalliche sono stampate a pressofusione e i materiali sintetici ad iniezione.

DE ein toller kundenstopper für textile banner: das maxiboard lässt sich aufklappen, die textilen banner mit flachkadersystem können jederzeit schnell gewechselt werden. alle teile sind aus hochwertigem silber-eloxiertem aluminium bzw. spritzguss aus metall und kunststoff.

EN a perfect A-board display for textile banners: the maxiboard is easily set up. the textile banners can be easily mounted using silicone strips. banner changing also is no big deal at all. all parts are made of high-grade silver anodized aluminium or die-cast parts made of metal and synthetics.

double sided



information

profilo in alluminio anodizzato color argento, metallo stampato a pressofusione, stampa a iniezione dei materiali sintetici

silber eloxiertes alu-profil, metall-druckguss, kunststoff spritzguss

silver anodized aluminium profile, die-cast metal, die-cast synthetics

- 1 500mm
- 2 720mm

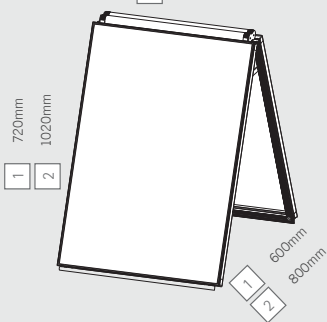

1 banner size: 720x520mm
visible size: 700x500mm

2 banner size: 1020x720mm
visible size: 1000x700mm

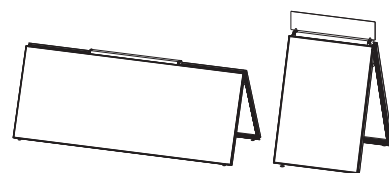

other possible combinations!

maxiboard ¹⁾

1	MXB700500	maxiboard 700x500mm, 1pc
2	MXB1000700	maxiboard 1000x700mm, 1pc

¹⁾ in vendita da aprile 2013 | auslieferung ab april 2013 | on sale from april 2013