

ghost 346	pixfix 100x100 347	pixfix safe 100x100 348	backframe 350	ring kombo 352	ring steel ring 352	nano 353	micro plast   micro steel 353	micro 354	mini 354	midi 355	budget 356
maxi 360	corner   border 361	safe   fast 362   363	rapid 364	three   four   six 365	mix alu 366-367	mix 368-369	steel 13-50 370-371	clamper 372	clip rail 374	x-man 376	wall-style 377

ring steel 386	nano 386	micro steel 386	steel safe 387	fixxo bond   fixxo steel 387	steel 13-50 388-389	steel plus 390	steel univers 390	steel ceiling-matic 391	steel pinch 391	steel union 392	steel unite 392

micro plast 396	tube 396	klipser 396	fixxo 397	ghost 398	panel connector 398	x-man 399	pixfix 400	pixfix safe 401	con 402	digiplug 403	connector 403

ceiling style 406	plus 408	plusmatic 408	con 409	fix 410	plusmini 410	plusdesign 410	loop 411	steel plus 411	steel univers 411	steel ceiling-matic 412	steel pinch 412

hook 414	univers mini 414	univers matic 414	union design 415	steel union 415	steel unite 415	uniplus 416	uniplus style 416	steel uniplus 416	steel wall pinch 417	punto 417	button 417

desk 420	table 420	punto 421	aven 421	croco cube 422	set antenna/ arco 422	antenna components 423	digiplug 424	connector 425	ix bond 426	artrail 427

			
rosett	zoom	fixxo bond   fixxo	peso
356	357	357   358	359



			
infoglass	infoplate glassgreen   square	infogquick infoplate round	maxipack
378	378-379	380	381-383

## FISSO WALL

distanziali a parete  
wandmontiert  
on the wall

344-383



	
steel uniplus	steel wall- pinch
393	393

## FISSO STEEL

acciaio  
stahl  
steel

384-393



## FISSO SYNTHETICS

sintetici  
kunststoff  
synthetics

394-403



			
univers	universdesign	perla	lasso
412	413	413	413

## FISSO CEILING

soffitto e bandiera  
decke und fahne  
ceiling and flagsigns

404-417



## FISSO SPECIAL

speciali  
spezial  
special

418-427

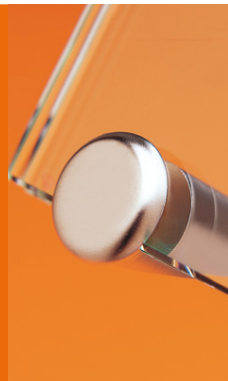

# FISSO WALL

## distanziali a parete

**IT** tutte le forme e le dimensioni dei distanziali a parete: nascosti oppure visibili, in ottone con cromatura di qualità, in acciaio inox oppure in materiale plastico. ideale per interni ed esterni, a prova di manomissioni ma anche facili e veloci da cambiare.





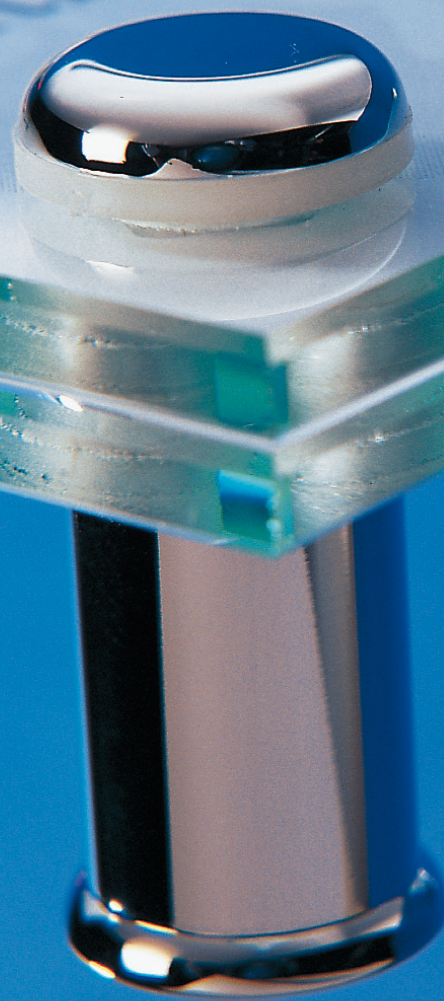

## wandmontiert

**DE** alle möglichkeiten und grössen der wandmontierten befestigung: verdeckt oder sichtbar, aus messing veredelt, rostfreiem stahl oder kunststoff, für den innen- oder aussenbereich, manipulationsgeschützt oder für den schnellen wechsel.

## on the wall

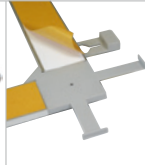
**EN** all the variety and sizes of wallmounted fasteners: visible or blind, made of plated brass, stainless steel or synthetic material, for inside or outside use, with protection against manipulation or for fast replacement.

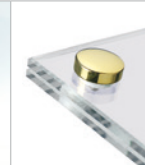





							
ghost	pixfix 100x100	pixfix safe 100x100	backframe	ring kombo	ring steel   ring	nano	micro plast
346	347	348	350	352	352	353	353

							
micro steel	micro	mini	midi	budget	rosett	zoom	fixxo bond
353	354	354	355	356	356	357	357

							
fixxo	peso	maxi	corner   border	safe	fast	rapid	three   four   six
358	359	360	361	362	363	364	365

							
mix alu	mix	steel 13-50	clamper	clip rail	x-man	wall-style	infoglass
366-367	368-369	370-371	372	374	376	377	378

			
infoplate glassgreen   square	infoquick	infoplate round	maxipack
378-379	380	380	381-383



ghost patented

MADE IN EU design by KD

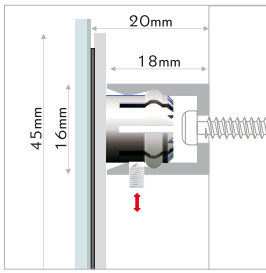
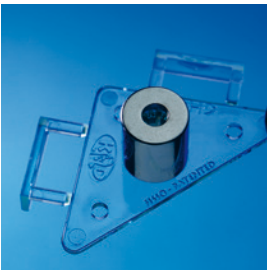

i distanziali in policarbonato possono venir fissati al pannello con della colla, silicone o biadesivo. su materiali adatti, con un certo spessore, è possibile fissare i distanziali con delle viti

abstandhalter können mit geeinigtem flüssigkleber, silikon oder doppelkleber befestigt werden. bei entsprechendem material schrauben sie die abstandhalter an

spacers can be mounted to the sign with appropriate glue, silicone or double faced adhesive tape. with adequate material mounting with screws is possible



**IT** il distanziale invisibile e semplice da montare. per tutti i casi in cui non siano graditi i distanziali visibili e quando si debba o si voglia rinunciare a forare la targa. posizionare sulla targa i distanziali in policarbonato (dotati di alette laterali staccabili per prendere la distanza dal bordo del pannello) e fissarli nella parte posteriore; marcare sulla parete i punti da forare grazie ai piccoli biadesivi e avvitare alla parete i distanziali in nichel; in seguito basterà agganciare la targa al muro esercitando una lieve pressione. fissaggio: a pressione, invisibile, per targhe e pannelli senza fori, veloce da cambiare, semplice da montare. materiale: policarbonato, ottone nichelato.

**DE** unsichtbare befestigung mit montagehilfe. immer wenn sichtbare halter unerwünscht sind und sie auf löcher verzichten müssen oder wollen. polycarbonathalter mit den randabstands-bügeln positionieren, auf der schilderrückseite befestigen, bohrlöcher mit den doppelklebern an der wand ganz einfach markieren, wandhülsen andübeln und das schild einklicken. befestigung: klicksystem, unsichtbar, für schilder ohne lochbohrung, schnell gewechselt, einfache montage. material: polycarbonat, messing vernickelt.

**EN** invisible fastener with fit-up aid. when you want to hide the fastener and you cannot or will not have holes in your sign. post the polycarbonate fastener using the removable leaves on your sign, fasten it with screws, glue, tape or silicone, mark the boreholes on the wall using the smart adhesive stickers, wallmount the spacers and click in the sign. mounting: click system, invisible, for signs without holes, quick to change, easy to mount. material: polycarbonate, brass nickel-plated.



**⚠** si prega di verificare se l'applicazione scelta è adatta per materiale e peso. quando si sceglie il montaggio con adesivi seguire le istruzioni del manuale rigorosamente.

**⚠** unbedingt testen, ob sich ihre gewählte anwendung für material und gewicht eignet. v.a. wenn sie befestigung mit klebstoffen wählen, befolgen sie die bedienungsanleitung.

**⚠** every application must be tested if suitable for material and weight, esp. when using adhesives follow manual instructions carefully.

combinations

	374		439
--	-----	--	-----



ghost | ghost | ghost  
FG4618K

1box pz/st/pc  
20pcs

# pixfix 100x100

MADE IN EU design by KD

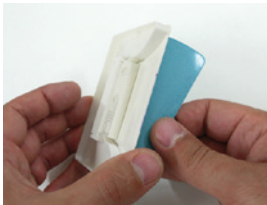
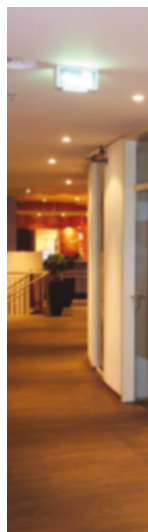
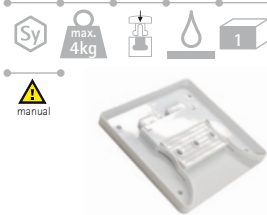
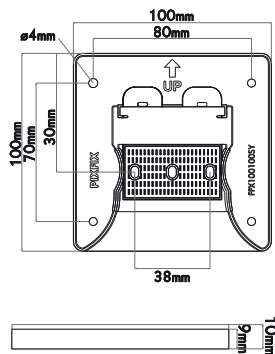
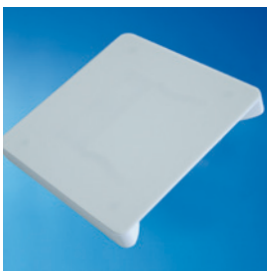

rimuovere il foglio di protezione del biadesivo  
*doppelkleberfolie abziehen*  
**remove adhesive tape foil**



incollare pixfix al pannello  
*pixfix am paneel aufkleben*  
**mount pixfix to the panel**

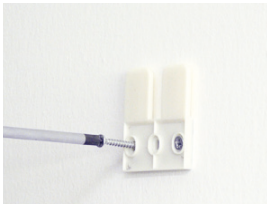

rimuovere la parte di pixfix che va a parete e montarla  
*wandhalter abnehmen und wandmontieren*  
**mount the wall support to the wall**

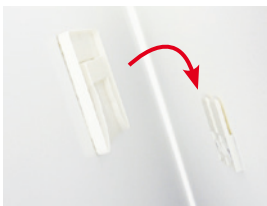

inserire il pannello sul supporto a parete montato in precedenza  
*paneel einfach auf wandhalter einklicken*  
**simply click in your panel**

**IT** pixfix vi entusiasmerà: il vostro pannello può essere fissato a parete in modo completamente invisibile e senza essere forato. grazie all'intelligente sistema di inserimento, i pannelli possono inoltre venir cambiati in qualsiasi momento. pixfix può essere fissato alla targa da esporre già direttamente in officina, così da risparmiare tempo sul luogo del montaggio. le dime per il montaggio sono davvero pratiche: si segnano così sul muro i punti dove effettuare i fori con il trapano, senza bisogno di prendere altre misure a vuoto. pixfix si adatta a tutti i materiali perchè può anche essere fissato ai pannelli con delle viti. distanza dal muro: 10mm.

**DE** pixfix wird sie begeistern: ganz ohne lochbohrung und unsichtbar wird ihr paneel befestigt. dank des cleveren einschubsystems können sie die paneele auch jederzeit ganz einfach austauschen. die befestigung von pixfix am paneel kann bereits in der werkstatt erfolgen, so sparen sie zeit bei der montage. praktisch die montageschablone: bohrlöcher werden einfach durch andrücken markiert, ohne umständliches ausmessen. pixfix ist geeignet für alle materialien und lässt sich auch mit schrauben am paneel befestigen. wandabstand: 10mm

**EN** pixfix will inspire you: without the need for holes in your panel and it secures it invisibly. thanks to the clever insert system you can simply exchange the panels at anytime. you can mount pixfix to your panels already in the work shop, saving time on-site later. the label positioning is convenient: press on the pixfix and drill holes which are simply marked on the wall. pixfix is suitable for all materials and can be also mounted with screws to the panel. distance from wall: 10mm



**⚠** si prega di verificare se l'applicazione scelta è adatta per materiale e peso. quando si sceglie il montaggio con adesivi seguire le istruzioni del manuale rigorosamente.

**⚠** unbedingt testen, ob sich ihre gewählte anwendung für material und gewicht eignet. v.a. wenn sie befestigung mit klebstoffen wählen, befolgen sie die bedienungsanleitung.

**⚠** every application must be tested if suitable for material and weight, esp. when using adhesives follow manual instructions carefully.



pixfix  
**FPX100100SY**

1pc

pz/st/pc



# pixfix safe 150x200

MADE IN EU design by KD

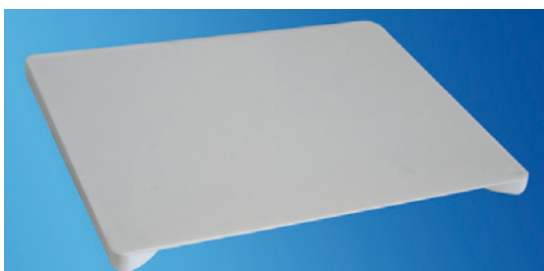

**IT** con il grande pixfix safe facciamo un grosso salto in avanti: adesso potrete fissare a parete senza doverle forare e con un sistema invisibile anche targhe e pannelli di grandi dimensioni. I pannelli possono essere incollati o avvitati al sistema di fissaggio. il clou: un sistema integrato di chiusura, di sicurezza, può essere attivato, a scelta, dopo il montaggio. in questo modo la vostra targa è a prova di furto. la calamita per tale uso è da ordinare separatamente.

**DE** mit dem grossen pixfix safe gehen wir einen schritt weiter: grosse platten befestigen sie damit unsichtbar und ohne lochbohrung. paneele können aufgeklebt oder aufgeschraubt werden. der clou: eine eingebaute sperre kann nach montage optional aktiviert werden. ihr panel ist damit manipulationsgeschützt und diebstahlsicher montiert. bestellen sie hierzu extra den passenden magneten.

**EN** with the bigger pixfix safe we go one step further: big panels can be mounted invisibly and without any holes. panels can be fixed with adhesive tape, glue or screws. the chief attraction: an integrated lock can be optionally activated after mounting easily. thus your panel is tamper- and thief-proof mounted. order the matching magnet extra.

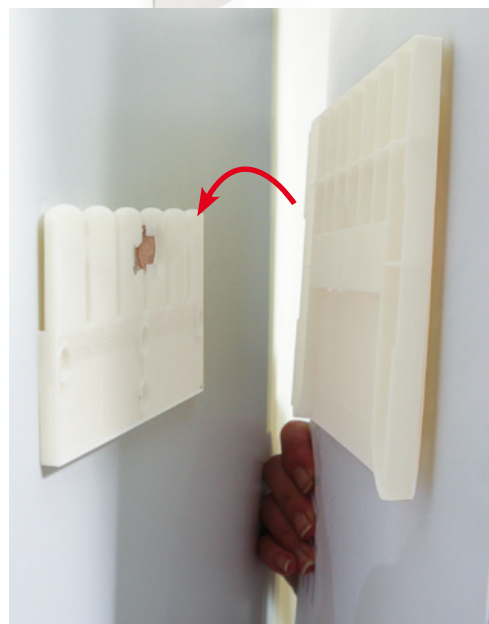
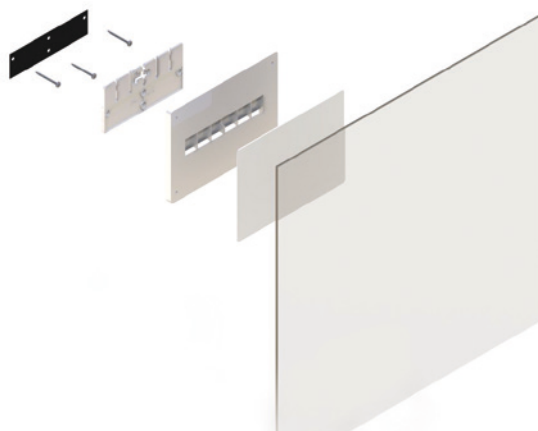
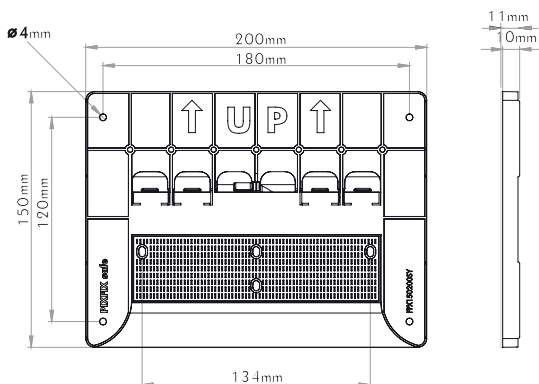

pixfix safe  
FPX150200SY 1pc pz/st/pc

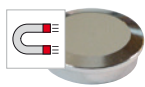

pixfix  
ACALPF magnet, 1pc pz/st/pc

**⚠** si prega di verificare se l'applicazione scelta è adatta per materiale e peso. quando si sceglie il montaggio con adesivi seguire le istruzioni del manuale rigorosamente.

**⚠** unbedingt testen, ob sich ihre gewählte anwendung für material und gewicht eignet. v.a. wenn sie befestigung mit klebstoffen wählen, befolgen sie die bedienungsanleitung.

**⚠** every application must be tested if suitable for material and weight, esp. when using adhesives follow manual instructions carefully.

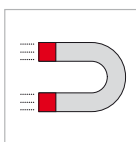

sistema brevettato a prova di furto: per fissare il pannello alla parete sarà sufficiente spostare la moneta al suo interno con un magnete, in questo modo il pixfix safe non potrà più essere rimosso. Per sbloccarlo sarà sufficiente avvicinare il magnete al pannello spostando la moneta e facendola tornare nella posizione iniziale, a questo punto sarà possibile rimuovere il pannello.

patente diebstahlsicherung: durch verschieben der innenliegenden münze mit magnet wird das wandmontierte paneel abgeschlossen, der pixfix kann nicht mehr nach oben gezogen werden. zum öffnen einfach mit dem magnet über das paneel fahren, die münze bewegt sich in die ausgangsposition und schon lässt sich das paneel wieder abnehmen.

tamperproof design: by moving the coin inside with magnet the wall mounted panel is locked, the pixfix cannot be moved upwards when locked. for opening simply move the magnet over the panel and the coin turns back into the initial position and the panel can be simply removed.







# backframe

MADE IN EU design by KD

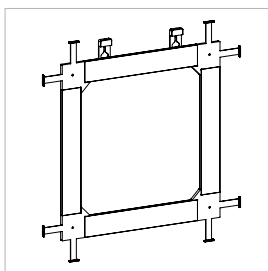
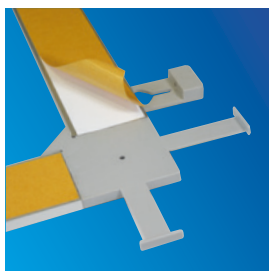

**IT** backframe provvede egregiamente al fissaggio, tra gli altri, di pannelli flessibili e sottili, come per esempio i semi espansi, il forex o l'alluminio, perchè assicura una tenuta perfetta, semplice ed estremamente sicura. particolarmente pratico è il sistema di livellatura che backframe offre e che può essere regolato fino a 10 mm, in modo che il vostro pannello sia sempre appeso diritto in modo perfetto, senza dover riforare il muro per riattaccarlo. offriamo backframe come set completo nei formati più comuni; in caso di richiesta sono disponibili altre lunghezze per formati su misure.

**DE** backframe sorgt als ein befestigung v.a. für flexible, dünne paneele z.b. aus hartschaum, forex oder aluminium für die nötige versteifung. zugleich befestigt der backframe ihr pannel sicher und einfach. besonders praktisch dabei die nivellierung fürs aufgehängte pannel, die vertikal bis zu 10mm unterschied reguliert, so dass ihr pannel immer gerade hängt ohne dass neu gebohrt werden muss. wir bieten ihnen backframe als komplettes set für gängige formate an. ausserdem erhalten sie auch alle seitenlängen extra für weitere formate.

**EN** backframe is a mounting system especially for thin and flexible panels made of hard-foam, forex or aluminium. it helps to stiffen the panel, while mounting is easy and safe. the leveling system is particularly convenient for the mounted panel, that can even be up to 10mm, so that your panel will always be straight without drilling new holes. we provide you with complete sets for common formats. also available are all lengths extra to create new sizes.



## included



4 profili in alluminio anodizzato color argento, 4 angolari in materiale plastico, quantità necessaria per livellatura a parete, cacciavite

4 silber eloxierte aluminiumprofile, 4 kunststoff eckverbinder, entsprechende nivellierungswandhaken, inbus-schlüssel

4 silver anodized aluminium profiles, 4 plastic edge connectors, needed quantity of leveling wall hooks, allen key

## backframe complete set

		pz/st/pc
1	FBAFA3	complete set for A3, 1pc
2	FBAF700500	complete set for 700x500mm, 1pc
3	FBAFA1	complete set for A1, 1pc
4	FBAF1000700	complete set for 1000x700mm, 1pc
5	FBAF14001000	complete set for 1400x1000mm, 1pc

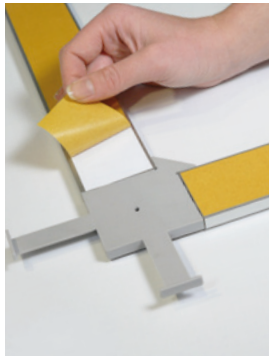
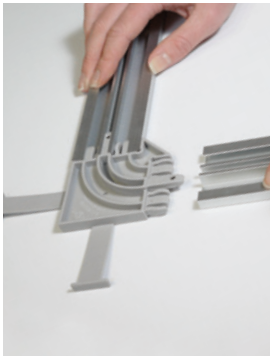

costruire la cornice, applicare il biadesivo, posizionare la cornice sul muro grazie al sistema di alette laterali per il montaggio, staccare tali alette e attaccare il pannello alla parete.

*rahmen zusammenbauen, doppelklebeband aufbringen, rahmen mittels montagehilfen positionieren, montagehilfen abreißen, paneel aufhängen.*

assemble the frame, put on the double sided adhesive tape, position the frame with the positioning straps, tear away straps, wall mount the panel



optional

l'angolo della struttura può anche essere avvitato al pannello.

*optional kann der eckverbinder auch direkt mit paneel verschraubt werden*

you have the option of also screw the edge connector directly to the panel

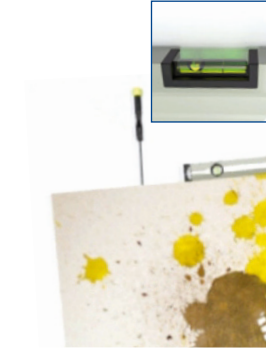
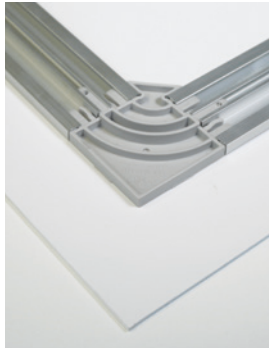
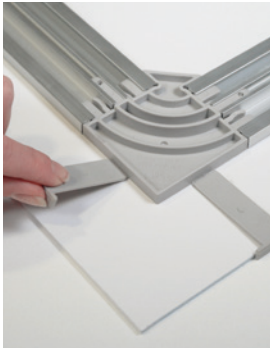

fissaggio a parete con livellatura: corregge dislivelli fino a 10mm dopo il montaggio.

*wandbefestigung mit nivellierung: gleicht bis zu 10mm nach montage aus.*

wall hook with levelling: evens up to 10mm after wall mount.

ulteriori informazioni pag. mehr details s. more information p.

138

## backframe wall lock

MADE IN EU design by KD

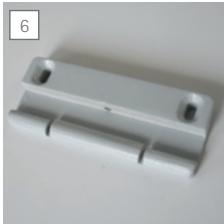

6

agganci a parete a prova di furto non livellabili in altezza, materiale plastico

*wandhaken mit diebstahlsicherung, nicht höhen-nivellierbar, kunststoff*

wall hook with theft protection, without leveling, synthetic



intelligente sistema a prova di furto: montate il wall lock a parete, sia nella parte superiore che in quella inferiore, agganciate il backframe e fissate il grano di sicurezza

*clevere diebstahlsicherung: wall lock für oben und unten wandmontieren, backframe einhängen und die obere madenschraube festziehen*

intelligent anti-theft system: mount the wall lock for upper and lower side, attach the backframe and close the upper grub screw

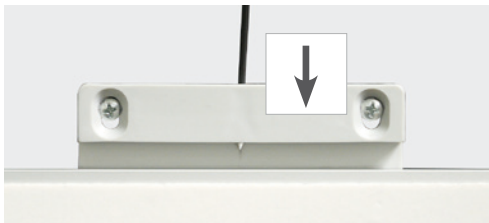

a prova di manomissione: con il grano fissato il backframe non potrà essere rimosso

*keine chance für langfinger: mit angezogener schraube kann der backframe nicht mehr abgenommen werden*

no chance for thieves. with the grub screw tightened the backframe cannot be removed

wall hook

6 FBAFSH

wall lock, 2pcs

## ring kombo

MADE IN EU design by KD

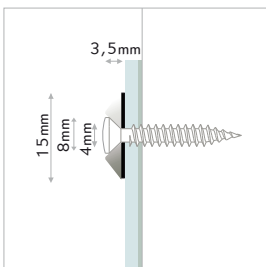

**IT** graziosa vite torx in inox, dotata di anellino in acciaio e gommino di protezione per non graffiare il materiale; pieno appoggio anti-scivolo. fissaggio: sistema a vite, montaggio frontale, uso universale. materiale: anellino e vite torx in acciaio inox, gommino di protezione.

**DE** ästhetische edelstahlschraube komplett mit edelstahl-ring und einlage. kein verkratzen des materials, rutsch-feste, satte auflage. befestigung: schraubensystem, frontale montage. material: ring, torxschraube edelstahl, schutzein-lage gummi.

**EN** appealing stainless steel torx screw complete with stainless steel jacket and inlay. no scratching, non-slip so-lid seating. mounting: screw system, frontal mounting. material: stainless steel ring with rubber, torx screw stainless steel.

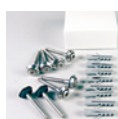

combinations

	396		378-379
--	-----	--	---------

acciaio | stahl | steel

FRING15KB

Ø15mm, 80pcs

1box

pz/st/pc

## ring steel

MADE IN EU design by KD

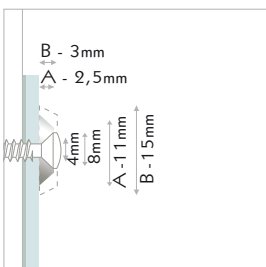

**IT** rosetta in acciaio massiccio. montaggio diretto a parete, per ogni tipo di materiale di qualsiasi spessore; fissaggio: sistema a vite, montaggio frontale, uso universale. materiale: acciaio inox AISI304, vite torx in acciaio inox.

**DE** rosette aus massivem edelstahl. direkte wandmontage, für alle materialien jeder stärke. befestigung: schraubensystem, frontale montage, universell verwendbar. material: edelstahl AISI304, torxschraube edelstahl.

**EN** rosette in solid stainless steel. mounting directly to the wall, for all materials, unlimited thickness. mounting: screw system, frontal mounting, all-purpose. material: stainless steel AISI304, torxscrew stainless steel.

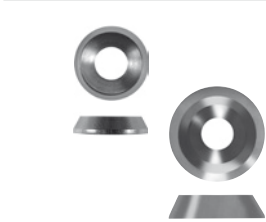

combinations

	396		378-379
--	-----	--	---------

acciaio | stahl | steel

FRG11IX

Ø11mm, 40pcs

1box

pz/st/pc

FRG15IX

Ø15mm, 40pcs

## ring

MADE IN EU design by KD

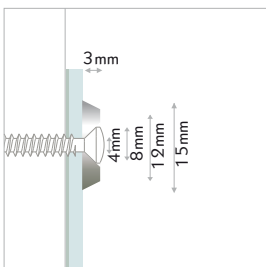

**IT** anellino in ottone pregiato. montaggio diretto a parete, per ogni tipo di materiale, con cromatura di qualità sulla superficie. fissaggio: sistema a vite, montaggio frontale, uso universale. materiale: anellino in ottone cromato, vite torx in acciaio inox.

**DE** veredelter messingring. direkte wandmontage, für alle materialien, mit hochwertiger oberflächenveredelung. befestigung: schraubensystem, frontale montage. material: torx-schraube edelstahl.

**EN** plated brass ring, for all materials, stainless steel torx screw, high-quality plated brass ring. mounting: screw system, frontal mounting, all-purpose. material: solid plated brass ring, torx screw stainless steel.



argento | silber | silver

FRG15AR \*

Ø15mm, 40pcs

1box

pz/st/pc

\* fino ad esaurimento scorte | solange vorrat reicht | while stock last

## nano

MADE IN EU design by KD

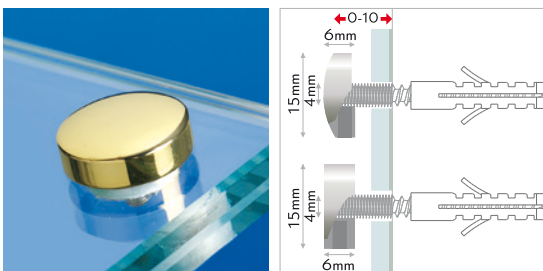

combinations

	396		178-379
--	-----	--	---------

**IT** coprivite decorativo avvitabile. per il fissaggio a parete tramite vite di congiunzione. fissaggio: montaggio frontale, per luoghi poco accessibili. materiale: ottone cromato o acciaio inox AISI304, rondella in nylon, vite di congiunzione.

**DE** stockschraube mit dekokappe. direkte wandmontage, befestigung: front-schraubsystem, für unzugängliche orte, material: messing veredelt bzw. edelstahl AISI 304, nylon-beilagscheibe, stockschraube.

**EN** hanger screw with decor head. mounting directly to the wall, for hard accessible places. mounting: frontal screw system, material: plated brass or stainless steel AISI 304, nylon washer, hanger screw.

		1 box	pz/st/pc
	cromo   chrom   chrome		
	FNANO15CM	40pcs	
	argento   silber   silver		
	FNANO15AR	40pcs	
	oro   gold   gold		
	FNANO15GD	40pcs	
	acciaio   stahl   steel		
	FNANO15IX	40pcs	

## micro plast

MADE IN EU design by KD

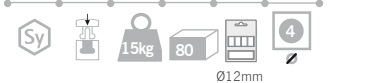
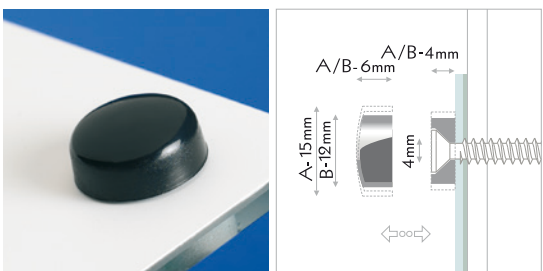

combinations

	396		378-379
--	-----	--	---------

**IT** conveniente coprivite a pressione. montaggio diretta a parete. fissare il coprivite a pressione direttamente sull'anellino. fissaggio: sistema a vite a pressione, montaggio frontale, per luoghi poco accessibili. materiale: materiale plastico colorato.

**DE** preisgünstiges klicksystem. direkte wandmontage, micro dekokappe einfach aufklicken. befestigung: frontales schraub-klicksystem. material: kunststoff farbig.

**EN** budget-priced fastener with click system. direct wallmounting, simply click the micro head on the fastener. mounting: frontal screw-klicksystem, material: coloured synthetics.

			1 box	pz/st/pc
	nero   schwarz   black			
	FMISY1000SZ	Ø12mm, 80pcs		
	FMISY1500SZ	Ø15mm, 80pcs		
	bianco   weiss   white			
	FMISY1000WE	Ø12mm, 80pcs		
	FMISY1500WE	Ø15mm, 80pcs		

## micro steel

MADE IN EU design by KD

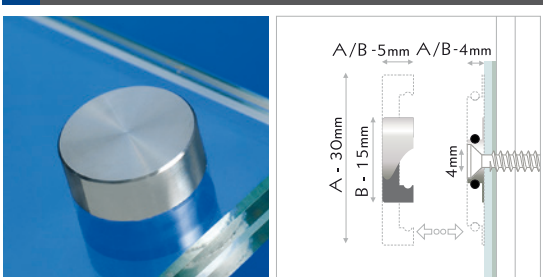

combinations

	374		439		396		378-379
--	-----	--	-----	--	-----	--	---------

**IT** coprivite decorativo in acciaio di qualità. il pannello si attacca a parete direttamente con il fissaggio micro. fissare il coprivite a pressione. fissaggio: sistema a vite a pressione, montaggio frontale, per luoghi poco accessibili. materiale: anellino in ottone, coprivite in inox AISI304.

**DE** hochwertige edelstahl dekokappe. paneel mit micro-halter direkt wandmontieren. micro dekokappe aufklicken. befestigung: schraub-klicksystem, frontmontage, für unzugängliche orte. material: halter messing, kappe AISI304 edelstahl.

**EN** high grade stainless steel deco head. mount the material with micro fastener directly on the wall. simply click the deco head on the fastener. mounting: frontal screw-klicksystem, for hard accessible places. material: fastener brass, head AISI304 steel.

			1 box	pz/st/pc
	acciaio   stahl   steel			
	FMI1500IX	Ø15mm, 40pcs		
	FMI3000IX*	Ø30mm, 40pcs		

\* fino ad esaurimento scorte | solange vorrat reicht | while stock lasts

## micro

MADE IN EU design by KD

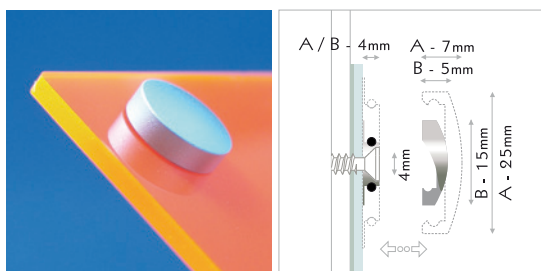

**IT** elegante coprivite a pressione. per il montaggio veloce e diretto a parete. fissaggio: sistema a vite a pressione, montaggio frontale, per luoghi poco accessibili. materiale: ottone, coprivite con cromatura.

**DE** edle dekokappe zum aufklicken. für schnelle und direkte wandmontage. befestigung: frontales schraub-klicksystem, für unzugängliche orte. material: messing, kappe veredelt.

**EN** noble deco head to click on. for quick and direct wall mounting. mounting: frontal screw-clicksystem, for hard accessible places, material: brass, head plated.

combinations

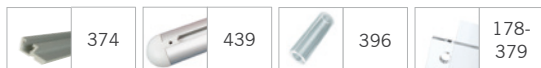

	cromo   chrom   chrome	1box	pz/st/pc
	FMI1500CM	Ø15mm, 40pcs	
	FMI2500CM	Ø25mm, 40pcs	
	argento   silber   silver		
	FMI1500AR	Ø15mm, 40pcs	
	FMI2500AR	Ø25mm, 40pcs	
	oro   gold   gold		
	FMI1500GD	Ø15mm, 40pcs	
	FMI2500GD	Ø25mm, 40pcs	

## mini patented

MADE IN EU design by KD

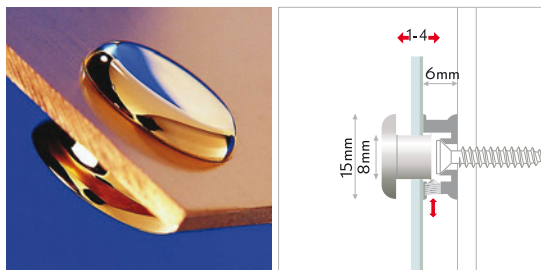

**IT** sistema a brugola con chiusura laterale di sicurezza per piccoli formati. fissaggio: sistema a brugola con chiusura laterale di sicurezza, a prova di manomissione. materiale: ottone con cromatura.

**DE** stecksystem mit arretierung für kleine formate. befestigung: stecksystem mit arretierung, manipulationssicher. material: veredeltes messing.

**EN** plug-interlocksystem for small sizes. mounting: plug-interlocksystem, tamper-proof. material: plated brass.

combinations



	nero   schwarz   black	1box	pz/st/pc
	FN1506SZ*	40pcs	
	cromo   chrom   chrome		
	FN1506CM	40pcs	
	argento   silber   silver		
	FN1506AR	40pcs	
	oro   gold   gold		
	FN1506GD	40pcs	

\* fino ad esaurimento scorte | solange vorrat reicht | while stock last

midi patented MADE IN EU design by KD

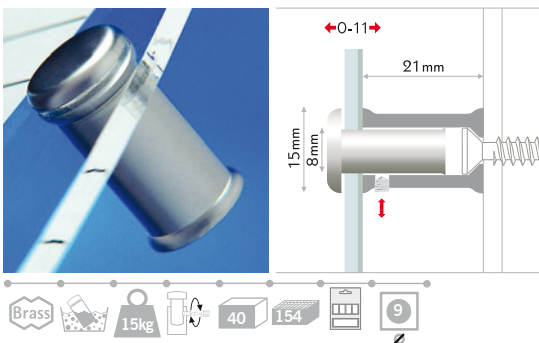

**IT** il classico sistema a brugola con chiusura laterale di sicurezza. fissare il distanziale alla parete, posizionare il pannello, inserire la testina nel foro e attraverso il pannello e completare il fissaggio tramite la brugola laterale di sicurezza, che impedisce che la targa possa venir manomessa o smontata. per lastre, targhe e pannelli di spessore medio. fissaggio: sistema a brugola con chiusura laterale di sicurezza, a prova di manomissione. materiale: ottone con cromatura color oro lucido, cromo lucido o argento satinato.

**DE** stecksystem mit arretierung für mittlere formate. halter an der wand befestigen, paneel auflegen, kopf durch das paneel in den halter stecken und mit seitlicher madenschraube im halter gegen manipulation sichern. für schilder, platten, paneele und borde mittlerer stärke. befestigung: stecksystem mit arretierung, manipulationsicher. material: messing oberflächenveredelt in gold, silber und chrom.

**EN** plug-interlocksystem for medium sizes. mount the fastener to the wall, put on the panel and plug the head through the panel into the fastener. fix the head in the fastener with the allen screw. for signs, panels and boards with medium size. mounting: plug-interlocksystem, tamper-proof. material: brass, gold-, silver- or chrome-plated. wall.

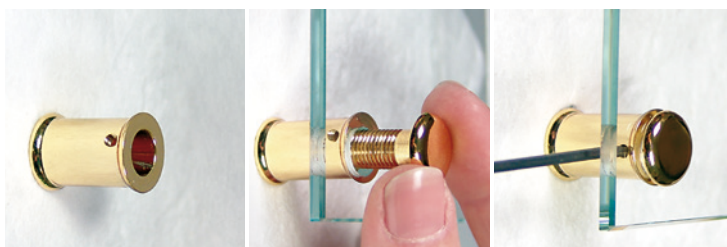

combinations

	374		439
	356		421
	378-379		

	cromo   chrom   chrome F1521CM	40pcs	
	argento   silber   silver F1521AR	40pcs	
	oro   gold   gold F1521GD	40pcs	

# budget

MADE IN EU design by KD

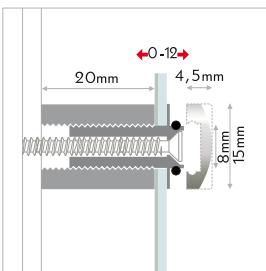

Brass 15kg 40 9

**IT** economico: premontare il pannello tra il distanziale e la parte centrale. avvitare la targa sul posto e posizionare la testina decorativa. fissaggio: sistema a vite, premontaggio. materiale: ottone, bussola nichelata, testina decorativa color oro, cromo o argento satinato.

**DE** ökonomisch: paneel zwischen hülse und wandhalter vormontieren. schild vor ort anschrauben, dekokappe aufdrücken. befestigung: schraubensystem für vormontage. material: messing, hülse vernickelt, dekokappe veredelt in gold, silber und chrom.

**EN** economical: pre-assemble panels between wall spacer and centerpiece. on site mount the sign to the wall, press on the deco-head. mounting: screwsystem for pre-assembly. material: brass, spacer nickel, deco head gold-, silver- or chrome-plated.

combinations

378-
379



	cromo   chrom   chrome	1box	pz/st/pc
	FBUD1520CM	40pcs	
	argento   silber   silver		
	FBUD1520AR	40pcs	
	oro   gold   gold		
	FBUD1520GD	40pcs	

# rosett

MADE IN EU design by KD

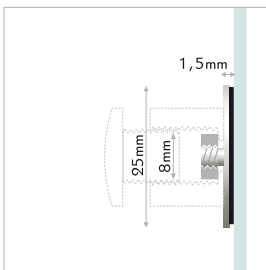

Brass manual 477 x 40



**IT** sistema di montaggio su vetro o superfici lisce con colla per distanziali. per distanziali fino a Ø25mm. fissaggio: sistema di montaggio su vetro. materiale: ottone cromato.

**DE** befestigungshilfe mit klebstoff auf glas und glatten oberflächen für distanzer. für distanzer bis Ø25mm. material: messing verchromt.

**EN** spacer mounting aid for glass and smooth surfaces with glue. for spacers with up to Ø25mm. material: chrome-plated brass.

combinations

	354		357-370
--	-----	--	---------



	cromato   verchromt   chrome-plated	1box	pz/st/pc
	FROS25CM	40pcs	

## ZOOM

MADE IN EU design by KD

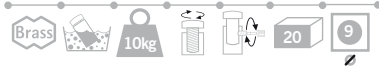
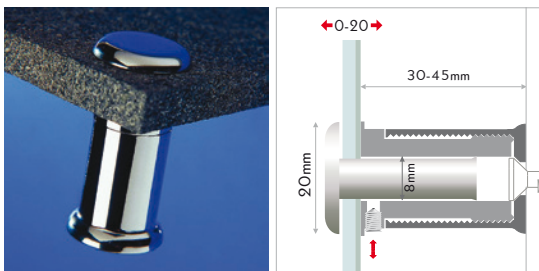

**IT** sistema di fissaggio con chiusura laterale di sicurezza, a distanza variabile dalla parete. fissare il distanziale alla parete, regolare la distanza dalla parete a piacere, svitando la parte centrale. ideale per il montaggio su pareti irregolari o inclinate. materiale: ottone con cromatura della superficie.

**DE** stecksystem mit arretierung, stufenlos variabler wandabstand, manipulationsgeschützt. halter an der wand befestigen, wandabstand durch aufschrauben der mittelhülse wie gewünscht einstellen. vor allem zum ausgleich bei unebenen oder schrägen wänden empfohlen. material: messing oberflächenveredelt

**EN** plug-interlocksystem infinitely variable wall distance, tamper-proof. mount the fastener to the wall, adjust the distance from wall by screwing the middle nut. especially recommended for the levelling of uneven or sloped walls. material: brass, plated.

combinations

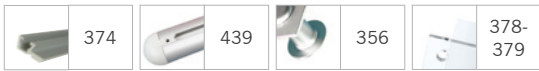

	cromo   chrom   chrome	1 box	pz/st/pc
	FZ2027CM	20pcs	
	argento   silber   silver		
	FZ2027AR	20pcs	

## fixxo bond

patented MADE IN EU design by KD

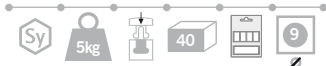
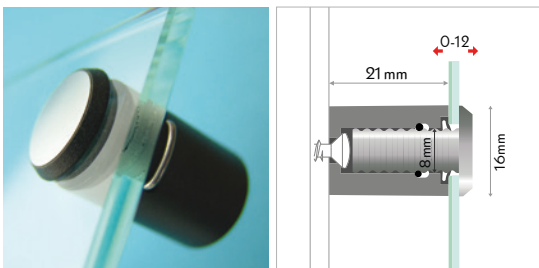

**IT** sistema variabile zigrinato con l'effetto inox, idoneo per l'esterno. l'insero in acciaio inox spazzolato fa un effetto speciale e puo essere personalizzato con stampa o adesivo. materiale: nylon color nero satinato, acciaio inox spazzolato.

**DE** variables raster-klemmsystem mit stahl-effekt, wetterfest. das gebürstete edelstahl-inlay im kopf verleiht effektvolle optik u. kann mit druck oder aufkleber personalisiert werden. befestigung: raster-klemmsystem, für unterschiedliche stärken. material: mattschwarzes nylon, gebürstet edelstahl.

**EN** variable grid-clampsystem with steel-look, weather-proof. the brushed stainless steel inlay of the head gives a special steel look and can be customized with print or label. mounting: grid-clampsystem, for different thickness. material: black matt nylon, brushed stainless steel.

combinations

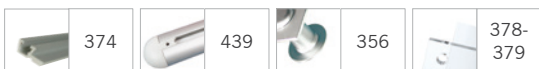

	cromo   chrom   chrome	1 box	pz/st/pc
	FB01621SZ	40pcs	





**fixxo** patented MADE IN EU design by KD

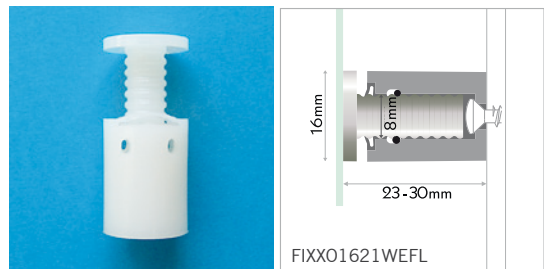
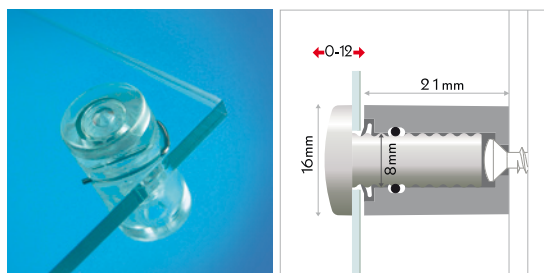

fixxo in colore bianco con la testa piatta (FIXXO1621WEFL) per montaggi invisibili di pannelli senza fori.

fixxo weiss mit flachkopf (FIXXO1621WEFL) für die unsichtbare montage ohne lochbohrung.

fixxo white with a flat head (FIXXO1621WEFL) for invisible mounting without holes.

combinations

	374		439
	356		421
	378-379		477

**IT** sistema variabile zigrinato. fissare il distanziale alla parete, posizionare il pannello, premere la testina nel foro e attraverso il pannello. le lamelle elastiche e sottili assicurano un fissaggio perfetto del pannello. la molletta laterale in acciaio blocca la testa del distanziale ed impedisce che la targa possa venir manomessa. fixxo in colore bianco è disponibile anche con la testa piatta (FIXXO1621WEFL) per montaggi invisibili di pannelli senza fori: incollare la testina direttamente al pannello con biadesivo, silicone o colla a due componenti. materiale: policarbonato o nylon cromato. distanza dalla parete: 21mm. spessore del pannello: fino a max 12mm.

**DE** variables raster-klemmsystem. abstandhalter wandmontieren, kopf durch das panel schieben und im distanzer einrasten. elastische plättchen sorgen für satte auflage des paneels. manipulationsschutz durch seitlich einschiebbare edelstahlfeder. fixxo weiss erhältlich mit flachkopf (FIXXO1621WEFL) für die unsichtbare montage ohne lochbohrung: material mit doppel-, silikon- oder 2-komponenten-kleber direkt auf dem kopf befestigen. material: transparentes polycarbonat bzw. farbiges oder verchromtes nylon. wandabstand: 21mm. plattenstärke: bis max. 12mm.

**EN** variable grid-clampsystem. wallmount the spacer, put the head through the panel and snap in the spacer. elastic small plates keep the panel solid seated. retractable stainless steel spring prevents from manipulation. fixxo white is available also with a flat head (FIXXO1621WEFL) for invisible mounting without holes: fix the panel with adhesive tape, silicone or superglue directly on the fixxo head. material: transparent polycarbonate resp. coloured or plated nylon. wall distance: 21mm. sign thickness: up to 12mm.

	nero satinato   schwarz matt   black matt	1box	pz/st/pc
	FIXXO1621MSZ	40pcs	
	grigio satinato   grau matt   grey matt FIXXO1621GR	40pcs	
	color vetro   glasgrün   glassgreen FIXXO1621GG	40pcs	
	bianco   weiss   white FIXXO1621WE	40pcs	
	FIXXO1621WEFL	40pcs	



peso

MADE IN EU design by KD

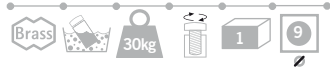
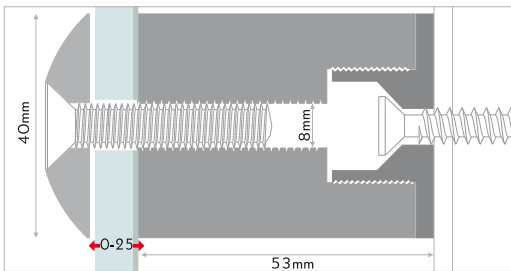

**IT** sistema di fissaggio per lastre di grandi dimensioni e spesse, adatto anche per l'utilizzo in ambienti architettonici. fissaggio: sistema di fissaggio a vite, montaggio frontale. materiale: ottone cromato, vite a brugola in acciaio inox, rondelle in poliuretano.

**DE** schraubensystem für grossformatige und schwere paneele, auch im architektonischen bereich. befestigung: schraubensystem, frontale montage. material: messing veredelt, inbusschraube edelstahl, PUR-beilagscheiben. .

**EN** screwsystem for large-format and heavy panels. especially used also in the range of architecture. mounting: screw system, frontal mounting. material: plated brass, stainless steel allen screw, PUR washer.



<p>chromo   chrom   chrome</p> <p>FPESO4053CM</p>	1pc	pz/st/pc
<p>argento   silber   silver</p> <p>FPESO4053AR</p>	1pc	



maxi

patented

MADE IN EU design by KD

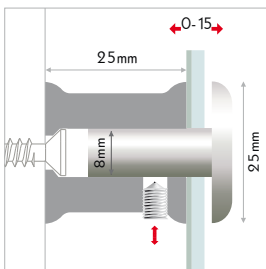

**IT** sistema di fissaggio con chiusura di sicurezza per grandi formati. fissare il distanziale alla parete, posizionare il pannello, inserire la testina nel foro e attraverso il pannello e completare il fissaggio tramite la brugola laterale di sicurezza, che impedisce che la targa possa venir manomessa o smontata. per lastre, targhe e pannelli di grandi dimensioni e spessori. fissaggio: sistema di fissaggio con chiusura laterale di sicurezza, a prova di manomissioni. materiale: ottone con cromatura della superficie.

**DE** stecksystem mit arretierung für grosse formate. halter an der wand befestigen, material auflegen, kopf durch das paneel in den halter stecken und mit seitlicher madenschraube im halter gegen manipulation sichern. für grossflächige schilder, platten, paneele und borde höherer stärke. befestigung: stecksystem mit arretierung, manipulationssicher. material: messing oberflächenveredelt.

**EN** plug-interlocksystem for big sizes. mount the fastener to the wall, put on the panel and plug the head through the panel into the fastener. fix the head in the fastener with the allen screw. for signs, panels and boards with bigger size. mounting: plug-interlocksystem, tamper-proof. material: plated brass.

combinations

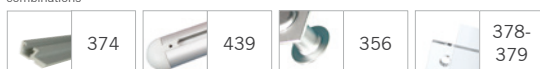

	cromo   chrom   chrome		1box	pz/st/pc
	FM2525CM	20pcs		
	FM2525AR	20pcs		
	FM2525GD	20pcs		

## corner

MADE IN EU design by KD

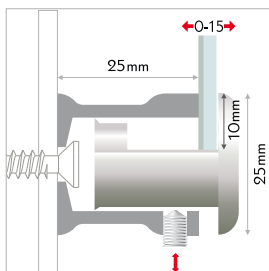

**IT** sistema di fissaggio angolare con chiusura di sicurezza, senza fori. materiale: ottone con cromatura.

**DE** Eckhalter, klemmsystem mit arretierung, ohne bohrung und manipulationsgeschützt. material: messing veredelt.

**EN** corner fastener without hole, clamp-interlocksystem, tamper-proof. material: plated brass.



combinations

	374		439		356		378-379
--	-----	--	-----	--	-----	--	---------

	romo   chrom   chrome	1 box	pz/st/pc
	FC2525CM	20pcs	
	argento   silber   silver		
	FC2525AR	20pcs	
	oro   gold   gold		
	FC2525GD *	20pcs	

\* fino ad esaurimento scorte | solange vorrat reicht | while stock last

## border

MADE IN EU design by KD

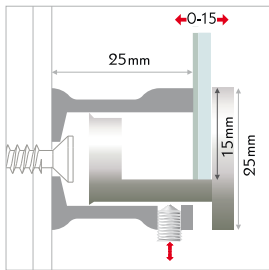

**IT** sistema di fissaggio laterale con chiusura di sicurezza., senza fori. materiale: ottone con cromatura

**DE** randhalter klemmsystem, ohne bohrung, manipulationsgeschützt. material: messing veredelt.

**EN** border fastener clamp system, tamper-proof, no holes. material: plated brass.



combinations

	374		439		356		378-379
--	-----	--	-----	--	-----	--	---------

	romo   chrom   chrome	1 box	pz/st/pc
	FB2525CM	20pcs	
	argento   silber   silver		
	FB2525AR	20pcs	

distanziali a parete | wandmontiert | on the wall

fisso



safe

MADE IN EU design by KD

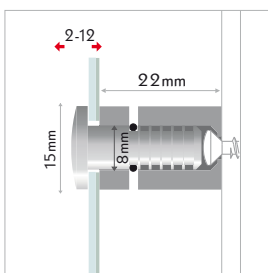

**IT** sistema variabile zigrinato, chiusura di sicurezza, veloce da montare. prima del montaggio inserire le testine nel pannello e le rondelle in pvc, montare i distanziali alla parete. le rondelle assicurano un fissaggio perfetto del pannello. premere il pannello con le testine nei fori dei distanziali. inserire la moletta per bloccare la testa contro la manipolazione. per lastre, targhe e pannelli di spessore medio. montaggio semplice e veloce. fissaggio: sistema zigrinato, con chiusura laterale di sicurezza. materiale: acciaio inox o ottone color cromo lucido o argento satinato.

**DE** variables raster-klemmsystem, manipulationsgeschützt und schnell. köpfe vor der montage durch das paneel und die pvc-scheibe stecken, hülssen an der wand befestigen. pvc-scheiben sorgen für satte auflage und halten die köpfe im paneel. köpfe dann einfach aufklicken. metallklemme einschieben und das paneel im halter gegen manipulation sichern. für schilder, platten, paneele und borde mittlerer stärke, schnelle, bequeme montage. befestigung: raster-klemmsystem mit arretierung, manipulationssicher. material: edelstahl bzw. messing versilbert oder verchromt.

**EN** variable grid-clampsystem, tamper-proof, quickly mounted. put the head through panel and washer, wallmount the spacers. the weak pvc washer secures full bearing of the panel and also holds the heads in the panel before mounting. now plug the heads into the spacers and insert the spring for secure and tamper-proof hold. for signs, panels and boards with medium size, mounting is quick and convenient. mounting: variable grid-clampsystem, tamper-proof. material: stainless steel or brass, silver- or chrome-plated.

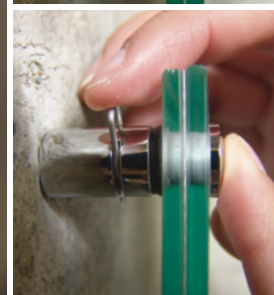
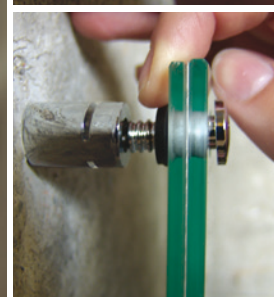

combinations

	374		439
	356		421
	378-379		

	cromo   chrom   chrome	40pcs	1box	pz/st/pc
	argento   silber   silver	40pcs		
	acciaio   stahl   steel	40pcs		

fast  MADE IN EU design by KD

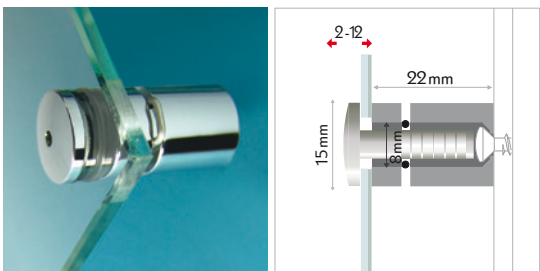

**IT** sistema variabile zigrinato, chiusura di sicurezza frontale, veloce. montare i distanziali alla parete, inserire la moletta. inserire le testine nel pannello e le rondelle in pvc. le rondelle assicurano un fissaggio perfetto del pannello. premere il pannello con le testine nei fori dei distanziali. per fissare avvitare le testine di 90°. il fissaggio è anche possibile centrale nel pannello grazie al sistema di fissaggio frontale tramite la testina.

**DE** variables raster-drehsystem, frontale sicherung, schnell. hülse wandmontieren, feder einschieben. köpfe durch das panel und die pvc-scheibe stecken, pvc-scheiben sorgen für satte auflage. köpfe dann einfach aufklicken und mit 90° dreh sichern. verwendung auch mittig in paneelen möglich, da die sicherung mit dem kopf selbst und nicht der hülse erfolgt.

**EN** variable grid-turnsystem, frontal lock, quick. wallmount the spacers, insert the spring. put the head through panel and washer. the weak pvc washer secures full bearing of the panel. now plug the heads into the spacers and rotate the heads 90° for locking. thanks to the frontal locking system with the head, the mounting in the center of panels is possible.

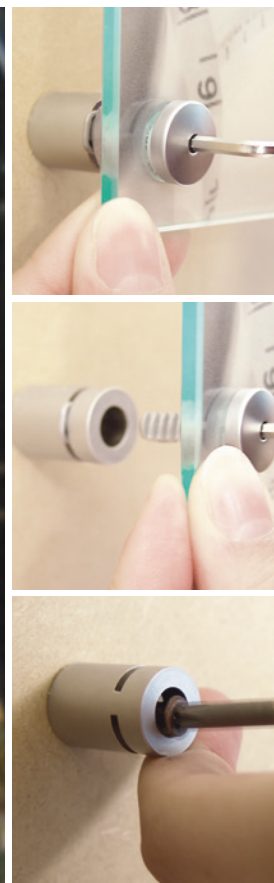
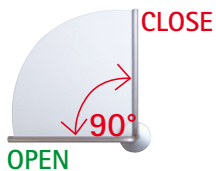

combinations

	374		439
	356		421
	378-379		

	cromo   chrom   chrome	1box	pz/st/pc
	FFA1320CM	40pcs	
	argento   silber   silver		
	FFA1320AR	40pcs	



rapid

patented

MADE IN EU design by KD

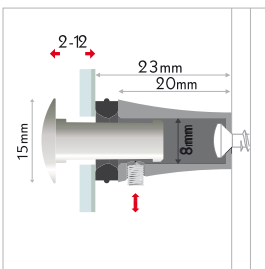

**IT** rivoluzionario sistema di fissaggio con chiusura di sicurezza. solo pochi giri saranno sufficienti per allargare la testina ed assicurare la targa sul distanziale. completo di rondelle „cuscinetto“ elastiche. materiale: zamac in diverse finiture.

**DE** revolutionäres steck-klemmsystem mit manipulationschutz. dank speziellen designs genügen wenige umdrehungen der madenschraube, der halter wird in der hülse aufgespreizt und gesichert. elastische beilagscheiben für satte auflage. veredelter metalledruckguss.

**EN** revolutionary tamperproof plug interlock system. just few turns of the allen screw will spread the head pin, fastening the panel to the standoff. elastic washers for a tighter fit. material: plated die-cast metal.

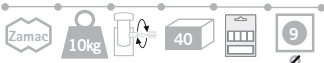

facile da usare, semplice e veloce: completi di grano già nella sua sede

*anwenderfreundlich, einfach und zeitsparend: vormontierte madenschraube.*

**user-friendly, hassle-free and time saving: pre-assembled allen screw**

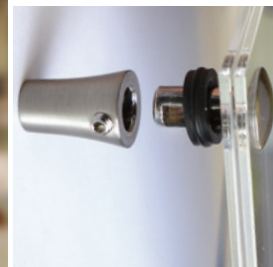

design intelligente: pochi giri del grano allargano la testina, semplice e sicuro.

*cleveres design: halter wird in der hülse mit wenigen umdrehungen gesichert.*

**clever design: head is spread with few turns in the spacer, fixing the panel safely**



Finish	Model	Quantity	Box	Unit
cromo   chrom   chrome	FRA1520CM	40pcs	1 box	pz/st/pc
argento   silber   silver	FRA1520AR	40pcs		
oro   gold   gold	FRA1520GD	40pcs		
rame satinato   kupfer matt   matt copper	FRA1520MCO	40pcs		
steel look   steel look   steel look	FRA1520IX	40pcs		
bronz veneziano   bronze veneziano   venetian brass	FRA1520VB	40pcs		

combinations



three | four | six

MADE IN EU design by KD

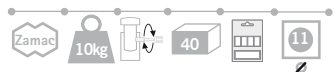
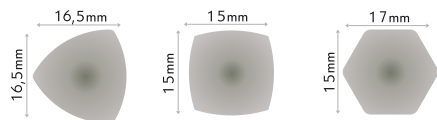
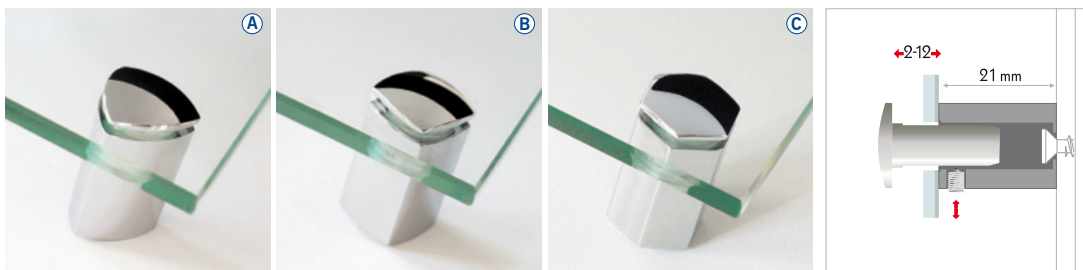

**IT** fisso three, fisso four o fisso six vi offrono un design stravagante e particolare: in metallo pregiato e disponibili nei colori più attuali, sono i veri e propri gioielli della linea fisso. fissaggio con grano laterale a prova di manomissione.

**DE** extravagant und ganz besonderes design bieten fisso three, fisso four oder fisso six: aus hochwertigem metalldruck guss und in topaktuellen farben sind sie die schmuckstücke der fisso linie. stecksystem mit manipulationsschutz und fallsicherung.

**EN** fancy and a very special design you find with fisso three, fisso four and fisso six: made of high-grade die cast metal and in up-to-date finishes these fixings are the real gems of the fisso line. tamper-proof plug-system with fall arrester.



	Cromo   chrom   chrome	1 box	pz/st/pc
<b>A</b>	FFT1621CM	40pcs	
<b>B</b>	FFF1621CM	40pcs	
<b>C</b>	FFS1621CM	40pcs	
	argento   silber   silver		
<b>A</b>	FFT1621AR	40pcs	
<b>B</b>	FFF1621AR	40pcs	
<b>C</b>	FFS1621AR	40pcs	
	oro   gold   gold		
<b>A</b>	FFT1621GD	40pcs	
<b>B</b>	FFF1621GD	40pcs	
<b>C</b>	FFS1621GD	40pcs	

	rame satinato   kupfer matt   matt copper	1 box	pz/st/pc
<b>A</b>	FFT1621MCO	40pcs	
<b>B</b>	FFF1621MCO	40pcs	
<b>C</b>	FFS1621MCO	40pcs	
	steel look   steel look   steel look		
<b>A</b>	FFT1621IX	40pcs	
<b>B</b>	FFF1621IX	40pcs	
<b>C</b>	FFS1621IX	40pcs	
	bronzo veneziano   bronze veneziano   venetian brass		
<b>A</b>	FFT1621VB	40pcs	
<b>B</b>	FFF1621VB	40pcs	
<b>C</b>	FFS1621VB	40pcs	





# mix alu

MADE IN EU design by KD

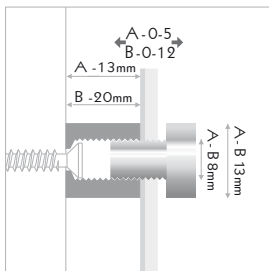

**IT** elegante sistema a vite in alluminio. montare il distanziale a muro e, dopo aver posizionato la targa, avvitare la testina sul distanziale. la testina è dotata di un forellino laterale che ne facilita l'avvitamento. a prova di impronte digitali. fissaggio: sistema a vite, montaggio frontale. materiale: alluminio anodizzato in color argento, oro, nero e titanio.

**DE** elegantes schraubensystem aus alu. halter wandmontieren, kopf durch das paneel in den halter schrauben. seitliche lochbohrung für verschrauben des kopfes. fingerabdruck-resistent. befestigung: schraubensystem, frontale montage. material: matt eloxiertes aluminium in silber, gold, schwarz und titan.

**EN** elegant aluminium screwsystem. wallmount the fastener, screw the head through the sign into the fastener. head with lateral hole for easy screwing. fingermark-proof. mounting: screw-system, frontal mounting. material: satin anodized aluminium in silver, gold, black and titan.

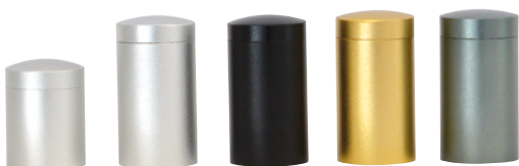
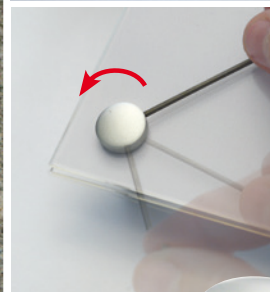
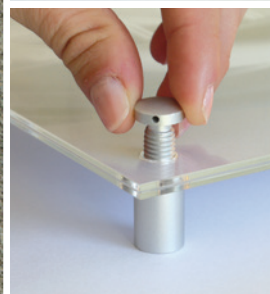
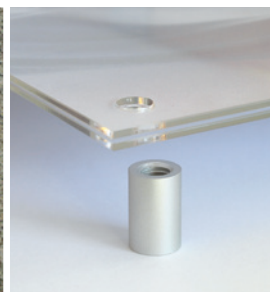
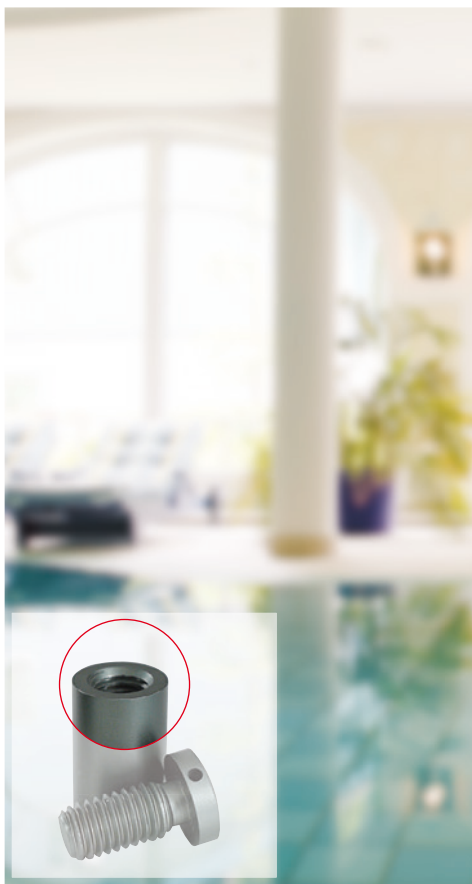

argento | silber | silver

1box

pz/st/pc

A: FMX1313AL

40pcs

B: FMX1320AL

40pcs

nero | schwarz | black

FMA1320MSZ

40pcs

oro | gold | gold

FMA1320MGD

40pcs

titanio | titan | titan

FMA1320TI

40pcs

combinations



# mix alu

MADE IN EU design by KD

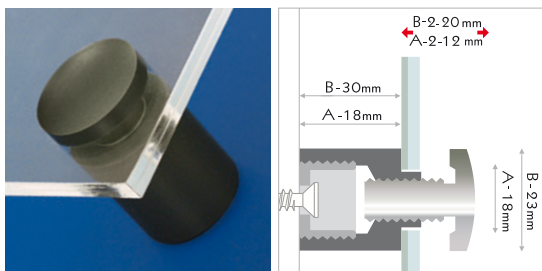

**IT** sistema di fissaggio a vite per grandi pannelli che offre una maggiore distanza dal muro. specifica conformazione per un facile posizionamento del pannello. resistente alle impronte lasciate dalle dita. fissaggio: sistema di fissaggio a vite, montaggio frontale. materiale: alluminio anodizzato in oro, argento, nero e titanio.

**DE** schraubsystem für grössere paneele mit mehr wandabstand. hülsenhals für leichtes positionieren des paneels. fingerabdruck-resistent. befestigung: schraubsystem, frontale montage. material: matt eloxiertes aluminium in silber, gold, schwarz und titan.

**EN** aluminium screw system for bigger panels with more distance to the wall. easy positioning of the panel thanks to the neck on the wall support. fingermark proof. mounting: screw system, frontal mounting. material: satin anodized aluminium in silver, gold, black and titan.

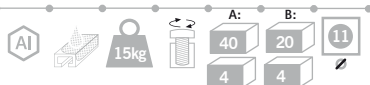

	argento   silber   silver	1box	pz/st/pc
	A: FMA1818AR	40pcs	
	B: FMA2330AR	20pcs	
	nero   schwarz   black		
	A: FMA1818MSZ	40pcs	
	B: FMA2330MSZ	20pcs	
	oro   gold   gold		
	A: FMA1818MGD	40pcs	
	B: FMA2330MGD	20pcs	
	titanio   titan   titan		
	A: FMA1818TI	40pcs	
	B: FMA2330TI	20pcs	

distanziali a parete | wandmontiert | on the wall

fisso



mix

MADE IN EU design by KD



**IT** sistema di fissaggio a vite – una vasta scelta. fisso mix offre la soluzione piú pratica per il fissaggio di lastre in posti poco accessibili come nicchie o angoli interni. fissare il distanziale alla parete, posizionare il pannello, inserire la testina nel foro e attraverso il pannello e avvitare per completare il fissaggio. materiale: ottone con cromatura

**DE** schraubensysteme - die grosse auswahl. fisso mix bietet die praktische lösung plattenmaterial an schwer zugänglichen orten wie nischen oder innenecken zu montieren. halter wandmontieren, kopf durch das panel stecken und in den halter schrauben. material: messing oberflächenveredelt

**EN** screwsystems - a wide choice. fisso mix is the convenient choice when you have to mount panels in niches and corners that are hard to reach. wallmount the fastener, put the head through the sign and screw it into the fastener. material: plated brass



diametro | Durchmesser | diameter  
 distanza muro | wandabstand | wall distance  
 foro | gewinde | thread  
 colore | farbe | colour

FMX 13 19M8GD

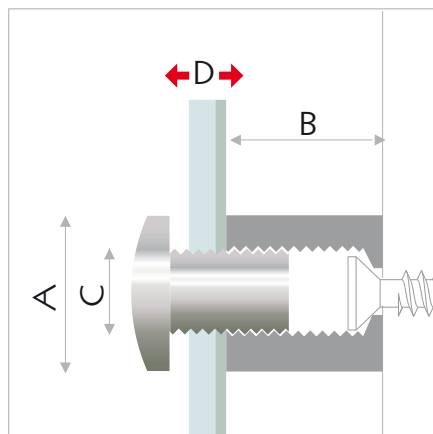

oro   gold   gold	40pcs	1 box	pz/st/pc
FMX1313M8GD	40pcs		
FMX1313M8CM	40pcs		
FMX1313M8AR	40pcs		

	A	B	C	D
FMX1313	13	13	8	5



oro   gold   gold	40pcs	1 box	pz/st/pc
FMX1319M8GD	40pcs		
FMX1319M8CM	40pcs		
FMX1319M8AR	40pcs		

	A	B	C	D
FMX1319	13	19	8	10



combinations	20pcs	1 box	pz/st/pc
FMX1925M12CM	20pcs		
FMX1925M12AR	20pcs		

	A	B	C	D
FMX1925	19	25	12	14

combinations	374	439	378-379



cromo   chrom   chrome	1box	pz/st/pc
FMX1930M12CM	20pcs	
argento   silber   silver		
FMX1930M12AR	20pcs	



	A	B	C	D
FMX1930	19	30	12	18



cromo   chrom   chrome	1box	pz/st/pc
FMX2530M12CM	20pcs	
argento   silber   silver		
FMX2530M12AR	20pcs	



	A	B	C	D
FMX2530	25	30	12	18



oro   gold   gold	1box	pz/st/pc
FMX2550M12GD*	10pcs	
cromo   chrom   chrome		
FMX2550M12CM	10pcs	
argento   silber   silver		
FMX2550M12AR	10pcs	



	A	B	C	D
FMX2550	25	50	12	25

\* fino ad esaurimento scorte | solange vorrat reicht | while stock last



cromo   chrom   chrome	1box	pz/st/pc
FMX3030M12CM	10pcs	
argento   silber   silver		
FMX3030M12AR	10pcs	



	A	B	C	D
FMX2550	30	30	12	20



oro   gold   gold	1box	pz/st/pc
FMX3060M12GD*	10pcs	



	A	B	C	D
FMX3060	30	60	12	30

\* fino ad esaurimento scorte | solange vorrat reicht | while stock last



oro   gold   gold	1box	pz/st/pc
FMX4040M12GD	6pcs	
cromo   chrom   chrome		
FMX4040M12CM	6pcs	
argento   silber   silver		
FMX4040M12AR	6pcs	



	A	B	C	D
FMX4040	40	40	12	25



oro   gold   gold	1box	pz/st/pc
FMX4080M12GD*	6pcs	



	A	B	C	D
FMX4080	40	80	12	30

\* fino ad esaurimento scorte | solange vorrat reicht | while stock last



distanziali a parete | wandmontiert | on the wall

fisso



## steel 13

MADE IN EU design by KD

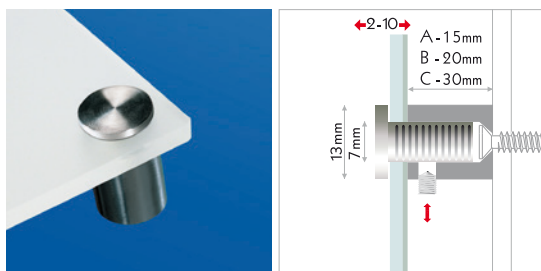

**IT** sistema di fissaggio in acciaio con chiusura laterale di sicurezza per piccoli formati. fissare il distanziale alla parete, posizionare il pannello, inserire la testina nel foro e attraverso il pannello e completare il fissaggio tramite la brugola laterale di sicurezza, che impedisce che la targa possa venir manomessa o smontata. materiale: acciaio inox AISI304, testina con sfaccettature.

**DE** hochwertiger edelstahl, elegante facettentoptik, stecksystem mit manipulationsgeschützter arretierung für kleine formate. halter an der wand befestigen, paneel auflegen, kopf durch das paneel in den halter stecken und mit seitlicher madenschraube im halter gegen manipulation sichern. material: edelstahl AISI304, facetteneffekt.

**EN** high-quality stainless steel, elegant facet appearance, plug-interlocksystem, tamper-proof, for small sizes. mount the fastener to the wall, put on the panel and plug the head through the panel into the fastener. fix the head in the fastener with the allen screw. material: stainless steel AISI304, head with facet cut.



combinations



acciaio   stahl   steel		1box	pz/st/pc
A: FS1315IX	40pcs		
B: FS1320IX	40pcs		
C: FS1330IX	20pcs		

## steel 15

MADE IN EU design by KD

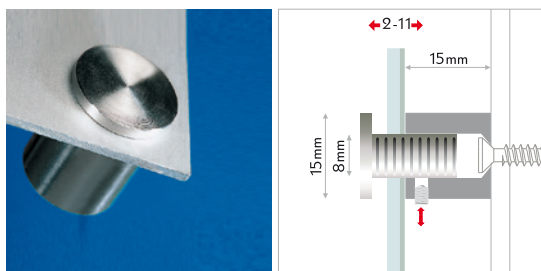

**IT** sistema di fissaggio in acciaio con chiusura laterale di sicurezza per piccoli formati. fissare il distanziale alla parete, posizionare il pannello, inserire la testina nel foro e attraverso il pannello e completare il fissaggio tramite la brugola laterale di sicurezza, che impedisce che la targa possa venir manomessa o smontata. materiale: acciaio inox AISI304, testina con sfaccettature

**DE** hochwertiger edelstahl, elegante facettentoptik, stecksystem mit manipulationsgeschützter arretierung für kleine formate. halter an der wand befestigen, paneel auflegen, kopf durch das paneel in den halter stecken und mit seitlicher madenschraube im halter gegen manipulation sichern. material: edelstahl AISI304, facetteneffekt

**EN** high-quality stainless steel, elegant facet appearance, plug-interlocksystem, tamper-proof, for small sizes. mount the fastener to the wall, put on the panel and plug the head through the panel into the fastener. fix the head in the fastener with the allen screw. material: stainless steel AISI304, head with facet cut.



combinations

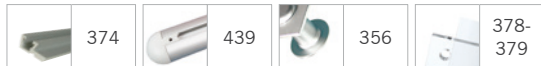

acciaio   stahl   steel		1box	pz/st/pc
FS1515IX	40pcs		

# steel 20

MADE IN EU design by KD

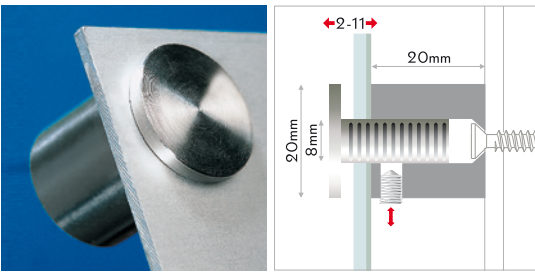

**IT** sistema di fissaggio in acciaio con chiusura laterale di sicurezza per formati medie. materiale: acciaio inox AISI304, testina con sfaccettature.

**DE** edelstahl-stecksystem mit manipulationsgeschützter arretierung, für mittlere formate. material: edelstahl AISI304, facetteneffekt.

**EN** stainless steel, plug-interlocksystem for middle sizes, tamper-proof. material: stainless steel AISI304, head with facet cut



combinations

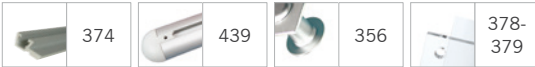

acciaio | stahl | steel 1 box pz/st/pc  
**FS2020IX** 40pcs

# steel 25

MADE IN EU design by KD

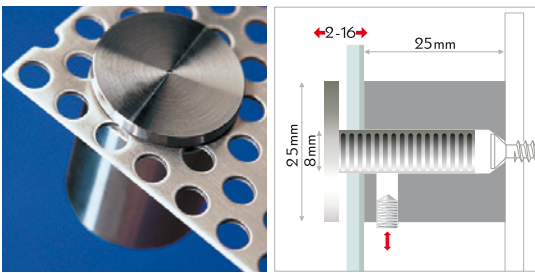

**IT** fissaggio in acciaio con chiusura laterale di sicurezza per formati grandi. materiale: acciaio inox AISI304, testina sfaccettata.

**DE** edelstahl-stecksystem mit manipulationsgeschützter arretierung für grosse formate. material: edelstahl AISI304, facetteneffekt.

**EN** stainless steel, plug-interlocksystem for big sizes, tamper-proof. material: stainless steel AISI304, head facet cut.

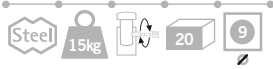

combinations



acciaio | stahl | steel 1 box pz/st/pc  
**FS2525IX** 20pcs

# steel 50

MADE IN EU design by KD

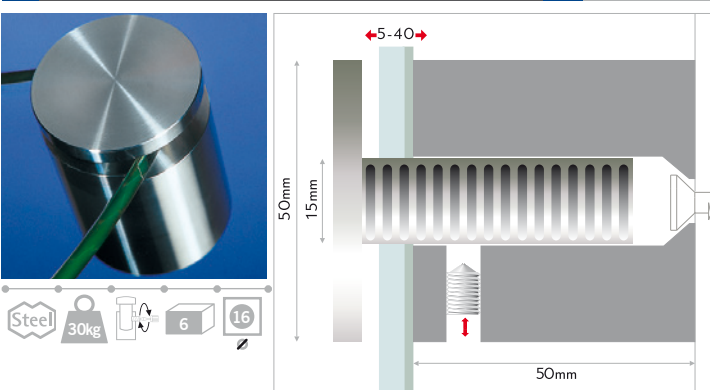

**IT** sistema di fissaggio in acciaio con chiusura laterale di sicurezza per lastre spesse e pesanti. materiale: acciaio inox AISI304, testina con sfaccettature.

**DE** stecksystem mit arretierung, edelstahl mit facettenoptik, für dicke, schwere paneele, manipulationsgeschützt. material: edelstahl AISI304, facetteneffekt.

**EN** plug-interlocksystem, faceted stainless steel for thick and heavy panels, tamper-proof. material: stainless steel AISI304, head facet cut.



combinations

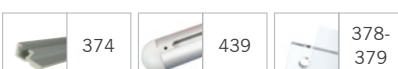

acciaio | stahl | steel 1 pc pz/st/pc  
**FS5050IX**

# clamper

MADE IN EU design by KD

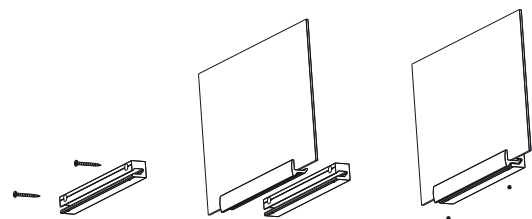
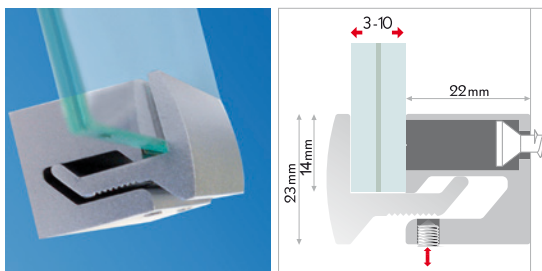

**IT** elegante sistema ad incastro, privo di fori. montare un profilo alla parete, agganciare l'altro profilo, inserire il pannello e fissarlo con i grani. pannelli di spessore diverso potranno essere assicurati senza bisogno di fori. clamper può essere usato in diverse lunghezze, mono -o bifacciale, per sistemi a sandwich o per singoli pannelli. abbiamo raggruppato per voi pannelli di vetro temperato nei formati più comuni. materiale: alluminio anodizzato argento.

**DE** variables klemmsystem, ohne bohrung. ein profil wandmontieren, das zweite einhaken, paneel auflegen und mit madenschrauben fixieren. paneele diverser stärken werden ohne bohrung sicher befestigt. sie können clamper in verschiedenen längen, ein- oder mehrseitig, im sandwichsystem oder mit einzelpaneelen verwenden. befestigung: klemmsystem ohne bohrung, manipulationssicher. material: silber eloxiertes aluminium. .

**EN** elegant clamp system, no holes. wall mount one profile, hook in the second, put on the panel and fix with allen screws. panels of different thicknesses are safely fastened without holes. you can use clamper in different lengths, on one or two sides, as sandwich system or with single panels. we provide you also with tempered glass panels in the most common sizes. mounting: variable clampssystem, tamper-proof. material: silver anodized aluminium.

clamper		pz/st/pc
FCL60	clamper, 60mm,1pc	
FCL100	clamper, 100mm,1pc	
FCL200	clamper, 200mm,1pc	
FCL300	clamper, 300mm,1pc	
FCL400	clamper, 400mm,1pc	
FCL600	clamper, 600mm,1pc	
FCL900	clamper, 900mm,1pc	
FCL2000	clamper, 2000mm,1pc	

tempered glass		pz/st/pc
FCL150150VE	glass, 150x150x4mm,1pc	
FCL150300VE	glass, 150x300x4mm,1pc	
FCL300450VE	glass,300x450x4mm,1pc	
FCL450600VE	glass, 450x600x4mm,1pc	
FCL200200VE	glass, 200x200x4mm,1pc	
FCL200400VE	glass, 200x400x4mm,1pc	
FCL250250VE	glass, 250x250x4mm,1pc	
FCL170370VE	glass, 170x370x4mm,1pc	

# clamper support

MADE IN EU design by KD

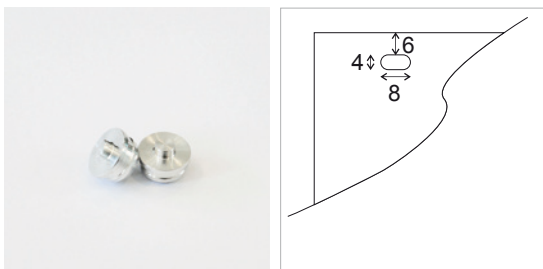

la distanza dei fori nel fisso clamper può variare, quindi prima di forare il pannello si prega di prendere le misure direttamente con il fisso clamper utilizzato.

*abstände der bohrungen bei fisso clamper, können variieren, daher masse für panelbohrung direkt bei den verwendeten fisso clamper abnehmen.*

the distance of the holes on fisso clamper can vary, therefore check the distance for panel holes directly with the fisso clamper used.

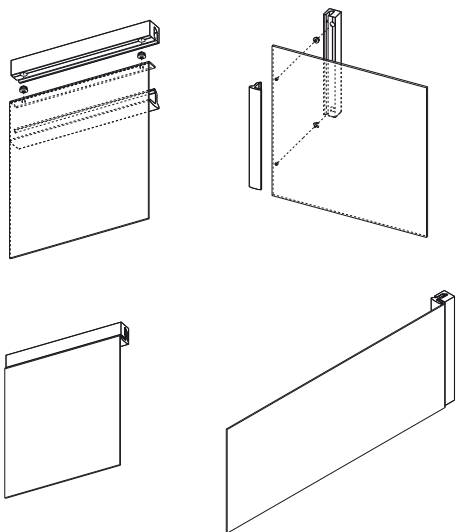

**IT** per il fissaggio perpendicolare di pannelli singoli, clamper support si fissa facilmente inserendo la lastra nei fori predisposti. se usato in combinazione con pannelli debitamente piegati e con clamper, potete creare anche della segnaletica a bandiera o a soffitto. materiale: alluminio.

**DE** für die senkrechte befestigung von einzelpaneelen, clamper support einfach in die lochbohrungen einsetzen. mit entsprechend gebogenen paneelen können sie clamper mit dem clamper support auch für decken- oder fahnschilder einsetzen. material: aluminium.

**EN** for the upright mounting of single panels you can simply insert the clamper support into the holes. clamper support even turns your clamper with shaped panels into a flag or ceiling sign support. material: aluminium.



acciaio | stahl | steel

FCL02AL

clamper support, 2pcs





## clip rail

MADE IN EU design by KD

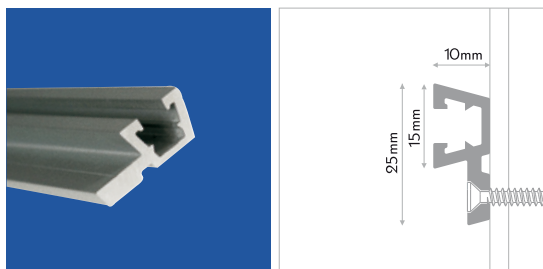

**IT** il pratico binario per il montaggio è dotato di dadi che si possono inserire nella cava, con un semplice clic, anche dopo l'installazione. i dadi di materiali plastico si possono spostare verticalmente sul binario in qualsiasi momento, facendo risparmiare tempo e denaro. cliprail si rivela essenziale soprattutto in caso di montaggio di molte targhe o quando la segnaletica debba venir cambiata con frequenza: il binario rimane sempre posizionato dove è stato montato. è necessario forare la parete solo una volta, le targhe possono poi essere cambiate o spostate facilmente sullo stesso binario. realizzato in alluminio anodizzato.

**DE** die praktische montageschiene mit nutsteinen zum einfachen einklipsen auch nach erfolgter montage. die kunststoff nutsteine lassen vertikal jederzeit verschieben. zeit und kostensparend, dabei immer exakt positioniert ist cliprail einfach praktisch bei montage von mehreren paneelen oder wenn schilder häufiger gewechselt werden. die wandbohrungen müssen nur einmal gemacht und die schilder können leicht ausgetauscht werden. aus silber eloxiertem aluminium.

**EN** the convenient mounting rail with sliding blocks that you can easily clip in even after wall mount mounting. the synthetic sliding blocks can be positioned anytime. saves time and money and always perfect in position, cliprail is simply perfect when you mount more panels or you want to exchange signs more often. the holes in the wall you need to drilled only once and the plates can be exchanged easily. cliprail is made of anodized aluminium.

✓ pratico: dadi in materiale plastico ad aggancio sul profilo  
 praktisch: nutstein zum einklipsen  
 handy: clip in thread nut

✓ flessibile: le targhe si possono spostare o cambiare a piacere  
 flexibel: jederzeit verschiebbar  
 flexible: movable anytime



alluminio | aluminium | aluminium

FCR1400

clip rail, 1400mm

pz/st/pc



# x-man

MADE IN EU design by KD

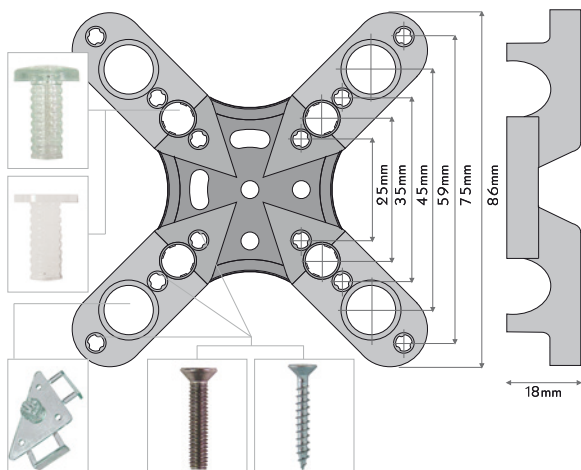

fissaggio di pannelli con viti.  
panelbefestigung mit schrauben.  
**panel mounting with screws.**

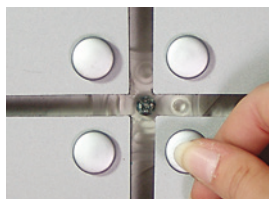

fissaggio di pannelli con il distanziale zigrinato fixxo.  
panelbefestigung mit fixxo klicksystem.  
**panel mounting with fixxo click-in.**

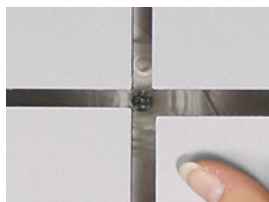

fissaggio invisibile di pannelli con ghost oppure con fixxo (FIXXK16WEFL).  
unsichtbare panelbefestigung mit ghost oder fixxo (FIXXK16WEFL).  
**invisible panel mounting with ghost or fixxo (FIXXK16WEFL).**

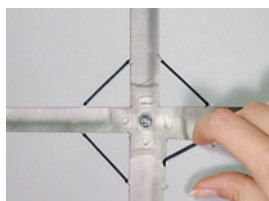

fissaggio dei pannelli con anellini di silicone.  
panelbefestigung mit silikon-ringen.  
**panel mounting with silicone oring.**

**IT** x-man: un talento nascosto. per il fissaggio di rivestimenti, pannelli, sistemi di informazione e molto di piú. il fissaggio puó essere visibile o invisibile, con viti, viti truciolari o con colla, fisso o rimovibile. ideale per luoghi di ingresso con molti pannelli o per pareti mobili. x-man puó essere montato centralmente o su un angolo. a seconda delle esigenze x-man puó essere usato in combinazione con i nostri distanziali e accessori. fissaggio: attacco a parete per viti, colla o a pressione. materiale: acrilico trasparente. nota bene: si prega di verificare se l'applicazione scelta è adatta per materiale e peso.

**DE** x-man: das multitalent im hintergrund. für die befestigung von verkleidungen, paneelen, informationssystemen und vielem mehr. befestigung sichtbar oder unsichtbar, mit schraube, holzschraube oder kleber, zum abnehmen oder fix montiert. ideal für eingangsbereiche mit vielen schildern oder für mobile wände. x-man kann zentriert oder auf eck montiert werden. kombinieren Sie x-man je nach bedarf mit unseren abstandhaltern und montagehilfen. befestigung: wandhalterung zum schrauben, kleben oder klicken. material: kunststoff, transparent. wichtiger hinweis: bitte testen sie die gewählte anwendung vorab auf eignung für material und gewicht.

**EN** x-man: allrounder in the background. for mounting of panelings, panels, information systems and much more. fastening is visible or invisible, with screw, woodscrew or glue, removable or fix. perfect for lobbies with a lot of signs or for mobile walls. you can mount x-man centered or on the corner. combine x-man according to your needs with our spacers and fit-up aids. mounting: wall holder for screwing, gluing or clicking. material: transparent synthetic. important note: please test in advance the chosen application if suitable for material and weight.

combinations



chiaro | klar | clear  
**FXMAN1885** 2pcs 1box pz/st/pc



col. vetro | glasgrün | glassgreen  
**FIXXK16GG** 40pcs



bianco | weiss | white  
**FIXXK16WEFL** 40pcs



chiaro | klar | clear  
**FGK4618K** 20pcs

# wall-style

MADE IN EU design by KD

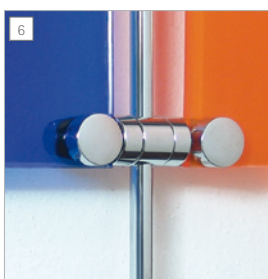
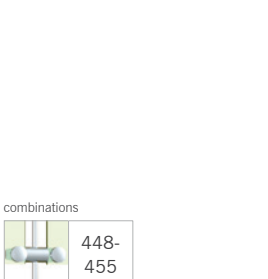

**IT** style, sistema di informazioni modulare a parete. regolare le astine del diametro di Ø6mm secondo la lunghezza desiderata. grazie alla combinazione dei due diversi formati (300mm e 400mm), è possibile variare la lunghezza del sistema a piacere, a partire da 600mm e in passi da 100mm. è possibile montare i pannelli frontalmente o lateralmente, grazie alla scelta dei distanziali. la lunghezza e la larghezza del sistema di informazioni sono variabili in qualsiasi momento grazie alla modularità degli elementi. materiale: ottone cromato lucido. distanza dalla parete: 18mm. spessore del pannello: max 10mm, spessori maggiori con brugole più lunghe. foro del pannello: Ø4mm.

**DE** style, modulares infosystem für die wand. die Ø6mm stangen je gewünschter länge verschrauben. durch kombination der von 300mm und 400mm sind ab 600mm alle längen in 100mm-schritten möglich. frontale oder seitliche paneelmontage je nach wahl des halters. jederzeit in länge und höhe erweiterbar durch die modulare bauweise. material: messing verchromt. wandabstand: 18mm. plattenstärke: max. 10mm, mehr mit längerer madenschraube. lochbohrung: Ø4mm.

**EN** style, modular information system, wallmounted. according to your needed length, screw the Ø6mm bars together. by combining the two lengths (300mm and 400mm) starting from 600mm all heights in 100mm-steps are possible. panels can be mounted lateral or frontal to the bar. height and width of your system can be enlarged anytime thanks to the modular design. material: brass chrome-plated. wall distance: 18mm. panel thickness: max. 10mm, more with longer allen screw. panel hole: Ø4mm.

combinations  
448-455

1	ASTA	cromo   chrom   chrome	1box	pz/st/pc
	YWS3006CM	300mm, 2pcs		
2	YWS4006CM	400mm, 2pcs		
2	CIMA	cromo   chrom   chrome		
	YWS1008CM	40pcs		
40				
3	FERMO	cromo   chrom   chrome		
	YWS1530CM	40pcs		
40				
4	MAESTRO	cromo   chrom   chrome		
	YWS1525CM	40pcs		
40				
5	LATO	cromo   chrom   chrome		
	YWS1545CM	40pcs		
40				
6	CUPIDO	cromo   chrom   chrome		
	YWS1568CM	10pcs		
10				

distanziali a parete | wandmontiert | on the wall

fisso



## infoglass

MADE IN EU design by KD

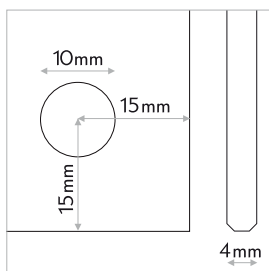
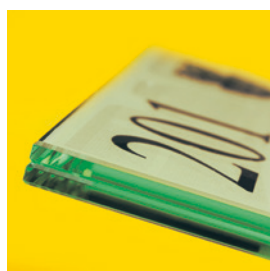

**IT** pannelli in vetro. elegante vetro temperato con bordi lucidati e sfaccettati con un'angolatura di 45°. da utilizzare singolarmente o in coppia per sistemi a sandwich. i pannelli sono già forati e completi con anellini di protezione. materiale: vetro temperato.

**DE** objektschild aus glas. temperiertes glas mit 45°-facettengeschliffenen kanten in ansprechender optik. einzeln oder im sandwich-system verwendbar. bereits mit lochbohrungen und inklusive glasschutzringe. material: temperiertes glas.

**EN** elegant glass sign. tempered glass with 45° faceted polished edge. use it single or double for sandwich systems. comes already with holes, glass protecting rings included. material: tempered glass.

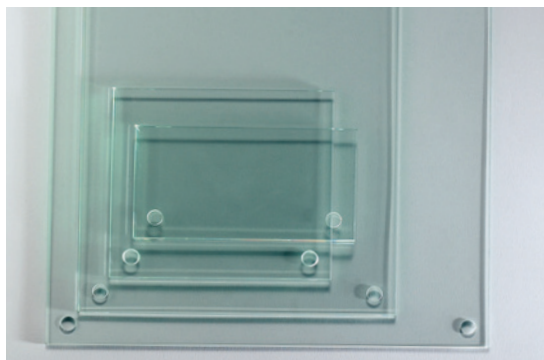

vetro   glas   glass	external size	nr. fori   nr. bohrungen   no. holes	pz/st/pc
IGA7L2M4	80x150mm, 1pc	nr 2	
IGA6L2M4	135x150mm, 1pc	nr 2	
IGA4L4M4	337x215mm, 1pc	nr 4	
IGA3L4M4	460x300mm, 1pc	nr 4	
IG100100L2M4	100x100mm, 1pc	nr 2	
IG100100L4M4*	100x100mm, 1pc	nr 4	
IG100200L2M4	100x200mm, 1pc	nr 2	
IG100200L4M4*	100x200mm, 1pc	nr 4	
IG150150L2M4	150x150mm, 1pc	nr 2	
IG150150L4M4	150x150mm, 1pc	nr 4	

\* fino ad esaurimento scorte | solange vorrat reicht | while stock last

## infoplate glassgreen

MADE IN EU design by KD

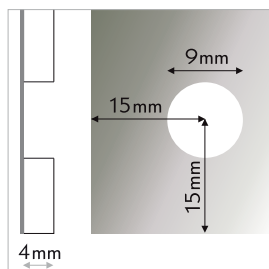
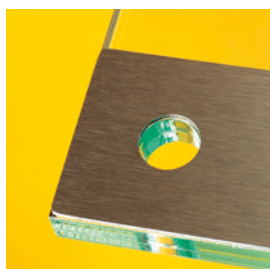

**IT** pannelli in acrilico color vetro. pannelli in acrilico che sembrano vetro ma che sono molto più leggeri. utilizzabile in molti modi per informazioni, indicatori di direzione o targhe. disponibili in molti formati e spessori con angoli politi e perfettamente rifiniti. altri formati disponibili a richiesta. particolarmente elegante e alla moda: la combinazione con le lastrine e i nostri distanziali in acciaio inox della linea STEEL. materiale: acrilico trasparente color vetro.

**DE** objektschild in glasgrünem acrylglas. leichter als glas und optisch kaum zu unterscheiden. vielseitig verwendbar, in vielen grössen und stärke, mit polierten schnittkanten. ihre wunschausführung bieten wir auf anfrage gerne an. besonders elegant und im trend: die kombination mit blende und befestigungen aus unserer edelstahllinie STEEL. material: acrylglas glasgrün transparent.

**EN** glassgreen acrylic signs. looks like glass but it is much lighter. multi-purpose usable for way-finding, information or pricing. comes in common sizes with polished edges. customized sizes on demand. elegant and trendy: the combination with faceplate and spacers of our stainless steel product line STEEL. material: glassgreen transparent acrylic glass.



vetro   glas   glass	external size	spessore   stärke   thickness	nr. fori   nr. bohrungen   no. holes	pz/st/pc
IGLA7L2M4*	80x150mm, 1pc	4mm	nr 2	
IGLA4L4M4*	337x215mm, 1pc	4mm	nr 4	

lastra d'acciaio spazzolato | edelstahlblende | faceplate brushed steel

IGL700500STEEL*	30x500mm, 1pc		nr 2	
-----------------	---------------	--	------	--

\* fino ad esaurimento scorte | solange vorrat reicht | while stock last

# infoplate square

MADE IN EU design by KD

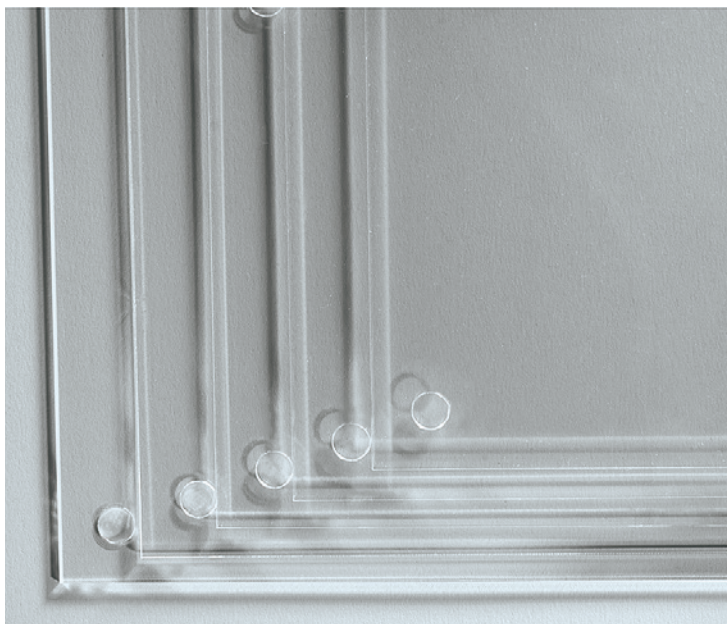
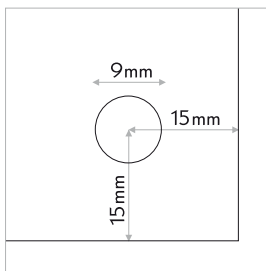

**IT** pannelli in acrilico trasparente. utilizzabili in molti modi per informazioni, indicatori di direzione, targhe. acrilico colato di alta qualità, disponibile in molti formati e spessori. una moderna tecnica laser garantisce una lavorazione esatta e angoli politi e perfettamente rifiniti. altri formati disponibili a richiesta. materiale: acrilico trasparente.

**DE** objektschild in transparentem acrylglas. vielseitig verwendbar für beschilderung, information oder preisauszeichnung. hochwertiges gegossenes acrylglas in einer grossen auswahl an grössen und stärken. moderne lasertechnik garantiert exakte bearbeitung und polierte schnitkanten. ihre wunschausführung bieten wir auf anfrage gerne an. material: acrylglas klar transparent.

**EN** transparent acrylic signs. multi-purpose usable for way-finding, information or pricing. high-quality casted acrylic glass comes in a wide range of size and thickness. state-of-the-art laser cutting ensures exact processing and polished edges. customized sizes on demand. material: clear transparent acrylic glass.

acrilico   acryl   acrylic	external size	spessore   stärke thickness	nr. fori   nr. bohrungen   no.holes	pz/st/pc
IEA7L2M2	80x150mm, 1pc	2mm	nr 2	
IEA7L2M4	80x150mm, 1pc	4mm	nr 2	
IEA6L2M4	135x150mm, 1pc	4mm	nr 2	
IEA6L2M8*	135x150mm, 1pc	8mm	nr 2	
IE150150L2M4	150x150mm, 1pc	4mm	nr 2	
IE150150L2M8*	150x150mm, 1pc	8mm	nr 2	
IE150150L4M4	150x150mm, 1pc	4mm	nr 4	
IE150150M4*	150x150mm, 1pc	4mm	nr 0	
IE200200L2M8*	200x200mm, 1pc	8mm	nr 2	
IEA4L4M4	337x215mm, 1pc	4mm	nr 4	
IEA3L4M2*	460x300mm, 1pc	2mm	nr 4	
IEA3L4M4	460x300mm, 1pc	4mm	nr 4	
IE400400L4M2*	400x400mm, 1pc	2mm	nr 4	

\* fino ad esaurimento scorte | solange vorrat reicht | while stock last



## infoquick

MADE IN EU design by KD

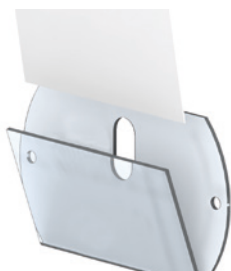
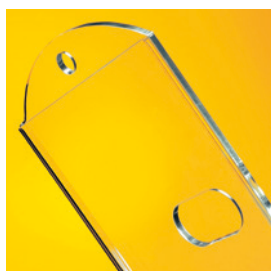

**IT** acrilico trasparente per un veloce cambio di informazioni. montare a parete infoquick ed inserire l'informazione. il plex piegato a tasca si apre facilmente. ideale dove si debbano cambiare informazioni frequentemente: menu e listini in ambito gastronomico, liste di eventi e manifestazioni in hotel, in centri per congressi e conferenze, in uffici o in ospedali, offerte del giorno in negozi o in agenzie di viaggio, corso delle azioni in banca, indicatori di direzione in uffici pubblici e assicurazioni. disponibile nei formati piú comuni e in diversi spessori. materiale: acrilico trasparente.

**DE** schnellinformation in transparentem acryl.infoquick wandmontieren und information einschleiben. die gebogene acryltasche lässt sich leicht öffnen und schliessen.ideal wo info häufig ausgetauscht wird: menükarten im gastronomiebetrieb, veranstaltungshinweise in hotels, konferenz- und seminarräumen, raumbelegung im büro oder krankenhaus, tagesangebote im einzelhandel oder reisebüro, aktienkurse in banks, hinweise in behörden und versicherungen. lieferbar in gängigen grössen und diversen stärke. material: acrylglas transparent.

**EN** quick information in transparent acrylic. wallmount infoquick and insert your information. the poster pocket opens and closes easily. perfect for often replacements: menu at restaurants, event notes at the hotel, for conferences and seminars, room signs at offices or in hospitals, daily offers at shops or travel agencies, stockquotation in banks, notes in boards and insurances. available in common sizes and different thicknesses. material: transparent acrylic glass.



acrilico   acryl   acrylic	external size	spessore   stärke thickness	nr. fori   nr. bohrungen   no.holes	pz/st/pc
IQA7L2M2	57x190mm, 1pc	2mm	nr 2	
IQA6L2M3	105x190mm, 1pc	3mm	nr 2	
IQA5L2M3	149x250mm, 1pc	3mm	nr 2	
IQA4L4M4	297x288mm, 1pc	4mm	nr 4	
IQA3L4M5	420x409mm, 1pc	5mm	nr 4	

## infoplate round

MADE IN EU design by KD

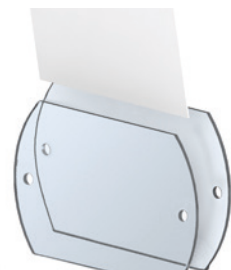

**IT** pannelli arrotondati in acrilico trasparente. elegante alternativa ai classici infoplate con una grande varietà di utilizzo: segnaletica, indicatori di direzione o anche come decorazione. angoli politi e perfettamente rifiniti, lavorazione esatta data da una moderna tecnica al laser. disponibile nei formati piú comuni e in diversi spessori. materiale: acrilico trasparente.

**DE** gerundetes, transparentes objektschild. formschöne alternative mit vielseitigen gestaltungsmöglichkeiten für leitsysteme, information oder dekoration. polierte schnitkanten, exakte bearbeitung durch moderne lasertechnik. lieferbar in gängigen grössen und diversen stärke. material: acrylglas transparent.

**EN** rounded, transparent sign. shapely alternative choice with manifold possibilities for signage, information or decoration. polished edges thanks to state-of-the-art lasercut. available in common sizes and different thicknesses. material: transparent acrylic glass.

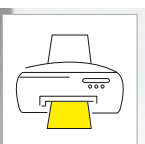

acrilico   acryl   acrylic	external size	spessore   stärke thickness	nr. fori   nr. bohrungen   no.holes	pz/st/pc
IA7L2M4	57x190mm, 1pc	4mm	nr 2	
IA6L2M4	105x190mm, 1pc	4mm	nr 2	
IA4L4M4	297x288mm, 1pc	4mm	nr 4	
IA3L4M2*	420x409mm, 1pc	2mm	nr 4	
IA3L4M4	420x409mm, 1pc	4mm	nr 4	
I700500L4M4	900x550mm, 1pc	4mm	nr 4	

\* fino ad esaurimento scorte | solange vorrat reicht | while stock last

# fiSSO maxipack

MADE IN EU design by KD



## mix alu pag. | s. | p. 366-367



mix alu 1313



13x13mm

mix alu 1320



13x20mm

mix alu 1818



18x20mm

mix alu 2330



23x30mm

order extra



	titanio   titan   titan	1box	pz/st/pc
<b>B</b>	FMAMP1320TI		
<b>C</b>	FMAMP1818TI		
<b>D</b>	FMAMP2330TI		

	oro   gold   gold	1box	pz/st/pc
<b>B</b>	FMAMP1320MGD		
<b>C</b>	FMAMP1818MGD		
<b>D</b>	FMAMP2330MGD		

	nero   schwarz   black		
<b>B</b>	FMAMP1320MSZ		
<b>C</b>	FMAMP1818MSZ		
<b>D</b>	FMAMP2330MSZ		

	argento   silber   silver		
<b>A</b>	FMXMP1313AL		
<b>B</b>	FMXMP1320AL		
<b>C</b>	FMAMP1818AR		
<b>D</b>	FMAMP2330AR		

## three | four | six pag. | s. | p. 365

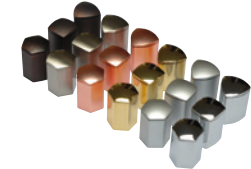

fisso three



fisso four



fisso six



order extra



	cromo   chrom   chrome	1box	pz/st/pc
<b>A</b>	FFTMP1621CM		
<b>B</b>	FFFMP1621CM		
<b>C</b>	FFSMP1621CM		

	oro   gold   gold	1box	pz/st/pc
<b>A</b>	FFTMP1621GD		
<b>B</b>	FFFMP1621GD		
<b>C</b>	FFSMP1621GD		

	argento   silber   silver	1box	pz/st/pc
<b>A</b>	FFTMP1621AR		
<b>B</b>	FFFMP1621AR		
<b>C</b>	FFSMP1621AR		

	rame satinato   kupfer matt   matt copper		
<b>A</b>	FFTMP1621MCO		
<b>B</b>	FFFMP1621MCO		
<b>C</b>	FFSMP1621MCO		

	steel look   steel look   steel look		
<b>A</b>	FFTMP1621IX		
<b>B</b>	FFFMP1621IX		
<b>C</b>	FFSMP1621IX		

	bronzo veneziano   bronze veneziano   venetian brass		
<b>A</b>	FFTMP1621VB		
<b>B</b>	FFFMP1621VB		
<b>C</b>	FFSMP1621VB		

## rapid pag. | s. | p. 364



154

order extra



ORINGIX15  
1box pz/st/pc

500



	cromo   chrom   chrome	1box	pz/st/pc
	FRAMP1520CM		
	argento   silber   silver		
	FRAMP1520AR		

	oro   gold   gold	1box	pz/st/pc
	FRAMP1520GD		
	rame satinato   kupfer matt   matt copper		
	FRAMP1520MCO		

	steel look	1box	pz/st/pc
	FRAMP1520IX		
	bronzo veneziano   bronze veneziano   venetian brass		
	FRAMP1520VB		





## midi

pag. | s. | p. 355



**order extra**

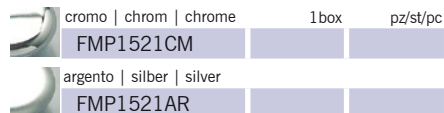
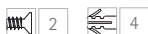
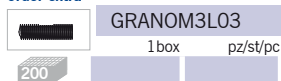

## maxi

pag. | s. | p. 360



**order extra**

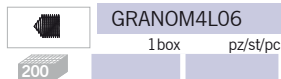

## border

pag. | s. | p. 361



**order extra**

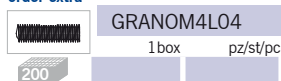

## corner

pag. | s. | p. 361



**order extra**

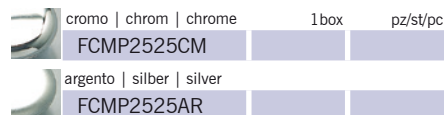
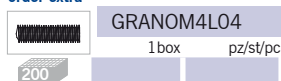

## fixxo

pag. | s. | p. 357



**order extra**

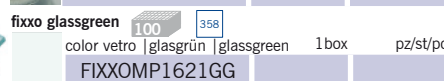
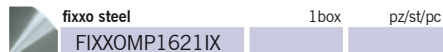

## steel 13

pag. | s. | p. 370



**order extra**

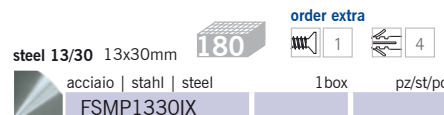
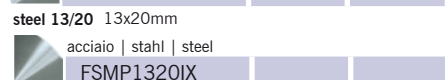
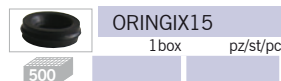

## steel 15 & 20

pag. | s. | p. 370-371



**order extra**

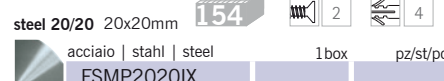
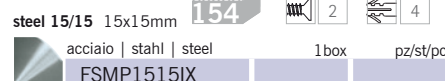
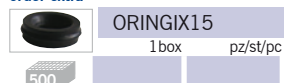

## steel 25

pag. | s. | p. 371



**order extra**

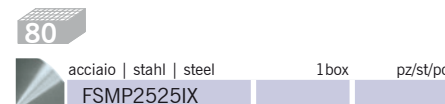
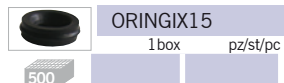

## mix

pag. | s. | p. 368

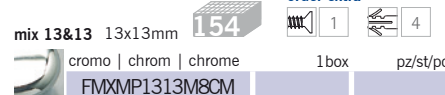

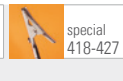
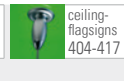
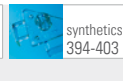
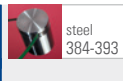

## plumatic pag. | s. | p. 408

**order extra**

30x35mm

60

2 4

cromo   chrom   chrome	1box	pz/st/pc
FPMMP3530CM		
argento   silber   silver		
FPMMP3530AR		

## perla pag. | s. | p. 413

**order extra**

15mm

154

GRANOM4L04

1box pz/st/pc

200

cromo   chrom   chrome	1box	pz/st/pc
FPEMP10CM		

## klipser pag. | s. | p. 396

15 x ø15mm 1box pz/st/pc

FKLMP1515

20 x ø20mm

FKLMP2020

30 x ø20mm

FKLMP2030

500

## ring kombo pag. | s. | p. 242

15mm

200

acciaio | stahl | steel
 1box | pz/st/pc || FRINGMP15KB |  |  |

## accessories

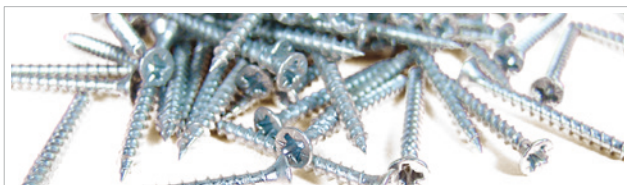

vite   schraube   screw	1box	pz/st/pc		
1	200	SKKR3L35		
2	200	SKKR4L35		
3	200	SKKR4L45		
tassello   dübel   anchor	1box	pz/st/pc		
4	100	TASS6L30NY		

**IT** anellini protetti-vetro, da utilizzare con INFOGLASS, confezionati in buste, con diametro interno Ø8mm o Ø4mm.

**DE** glasschutzringe, für die verwendung mit INFOGLASS. im nylonbeutel mit innendurchmesser Ø8mm oder Ø4mm.

**EN** glass protection ring, to be used with INFOGLASS products. in nylon bags with inner diameter Ø8mm or Ø4mm.

10

5	ARIP15/8	ø8mm	1box	pz/st/pc
6	ARIP15/4	ø4mm		

**IT** chiavi con impugnatura blu ACHI15 per brugole da 1,5mm e con impugnatura gialla ACHI20 per brugole da 2mm.

**DE** inbusschlüssel mit blauem griff ACHI15 für inbusschrauben 1,5mm, mit gelbem griff ACHI20 für inbusschrauben 2mm.

**EN** allen keys with blue handle ACHI15 for 1,5mm allen screws, with yellow handle ACHI20 for 2mm allen screws.

7	ACHI15	1,5mm		pz/st/pc
8	ACHI20	2mm		

**IT** biadesivo a peduncoli plastici removibili, forte tenuta.

**DE** selbstklebendes in sich schliessendes pilzkopfband, vielfach wieder lösbar, stark haftend.

**EN** self-locking reclosable adhesive tape with mushroom heads, strong durable hold.

10

9

AVE2525	25x25mm 4 set	1box	pz/st/pc
AVE252000	2m25mm	1 roll	1m

**IT** biadesivo in rotoli. larghezza: 15mm. rotolo: 9m.

**DE** doppelklebeband auf rolle. breite: 15mm. rolle: 9m.

**EN** double adhesive tape. width: 15mm. length: 9m.

ATP1509	9m	1 roll	1m
---------	----	--------	----

**IT** cavo d'acciaio Ø1,7mm o d'acciaio inox Ø1,2mm, sempre rivestito di pvc. rotoli da 5m, 25m e 500m. per sistemi in tensione con gli articoli delle linee fisso o fly.

**DE** stahlseil Ø1,7mm oder edelstahlseil Ø1,2mm, jeweils pvc beschichtet. konfektionen zu 5m, 25m und 500m. für seilspannsysteme mit fisso- oder fly-produkten.

**EN** steel cable Ø1,7mm or stainless steel cable Ø1,2mm, both pvc coated. in coils of 5m, 25m and 500m. for suspension systems with fisso- or fly-products.

12-17

inox   stahl   steel			1m
AFIL05	Ø1,7mm, 5m		
AFIL25	Ø1,7mm, 25m		
ABOB500	Ø1,7mm, 500m		
inox   edelstahl   stainless steel			1m
AFILIX05	Ø1,2mm, 5m		
AFILIX25	Ø1,2mm, 25m		
AFILIX500	Ø1,2mm, 500m		

distanziali a parete | wandmontiert | on the wall

**fisso**

# FISSO STEEL

## fisso acciaio

**IT** la linea completa in acciaio inox inossidabile di alta qualità (AISI304 e 303): distanziali per fissaggi a parete, a soffitto o per applicazioni speciali, per l'interno e per l'esterno, con diversi sistemi di fissaggio e di chiusura.

## fisso stahl







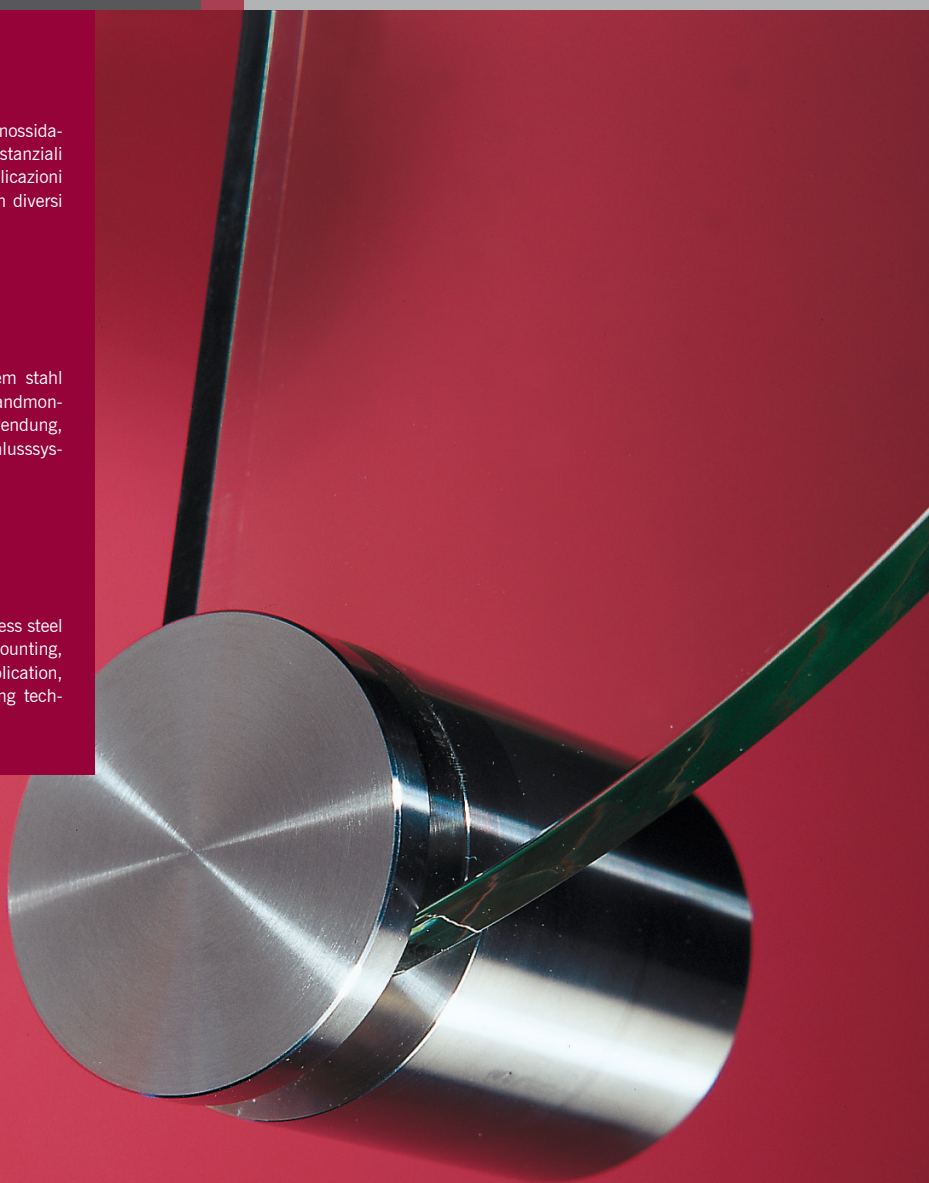

**DE** alles aus hochqualitativem rostfreiem stahl (AISI 304 und 303): befestigungen für wandmontage, deckenabhängung oder spezialanwendung, für innen und aussen, mit diversen verschlussystemen.



## fisso steel

**EN** everything made of highquality stainless steel (AISI 304 and 303): fasteners for wallmounting, suspension systems or other special application, for in- and outdoor, with different closing techniques.



							
ring steel	nano	micro steel	steel safe	fixxo bond	fixxo steel	steel 13	steel 15
386	386	386	387	387	387	388	388

							
steel 20	steel 25	steel 50	steel plus	steel univers	steel ceilingmatic	steel pinch	steel union
389	389	389	390	390	391	391	392

		
steel unite	steel uniplus	steel wallpinch
392	393	393



## ring steel

MADE IN EU design by KD

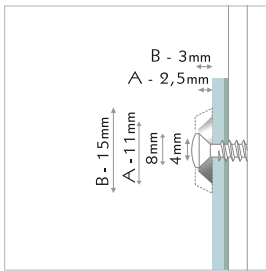

**IT** rosetta in acciaio massiccio. montaggio diretto a parete, per ogni tipo di materiale di qualsiasi spessore; graziosa vite torx in acciaio inox. materiale: acciaio inox AISI304, vite torx in acciaio inox. distanza dalla parete: 0mm. spessore del pannello: nessun limite.

**DE** rosette aus massivem edelstahl. direkte wandmontage, für alle materialien jeder stärke, ästhetische edelstahlschraube mit rosette aus massivem edelstahl. material: edelstahl AISI304, torxschraube edelstahl. wandabstand: 0mm. plattenstärke: frei.

**EN** rosette in solid stainless steel. mounting directly to the wall, for all materials, unlimited thickness, appealing stainless steel torx screw and solid stainless steel ring. material: stainless steel AISI304, torxscrew stainless steel. wall distance: 0mm. sign thickness: unlimited.



combinations



acciaio | stahl | steel

FRG11IX

Ø11mm, 40pcs

1box

pz/st/pc

FRG15IX

Ø15mm 40pcs

## nano

MADE IN EU design by KD

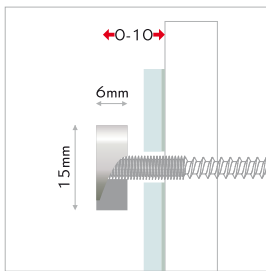
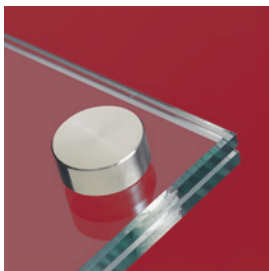

**IT** coprivite decorativo avvitabile, per piccoli fori. coprivite filettato con rondella per il fissaggio tramite vite di congiunzione senza alcuna distanza. forellini di Ø5mm sono sufficienti. fissaggio: sistema a vite, montaggio frontale. materiale: acciaio inox AISI304, rondella nylon, vite di congiunzione.

**DE** aufschraubbare dekokappe für frontale montage, kleine bohrung. dekokappe mit gewinde und beilagscheibe zur befestigung mit stockschrauben ohne wandabstand. paneel-bohrung: Ø5mm. material: edelstahl AISI 304, nylon-beilagscheibe, stockschraube.

**EN** screw-on decor head for frontal mounting, small holes. nano decor head with thread and washer for mounting with hanger screw directly to the wall. panel hole: Ø5mm. material: stainless steel AISI 304, with nylon washer and hanger screw.



combinations

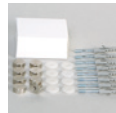
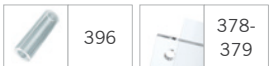

acciaio | stahl | steel

FNANO15IX

40pcs

1box

pz/st/pc

## micro steel

MADE IN EU design by KD

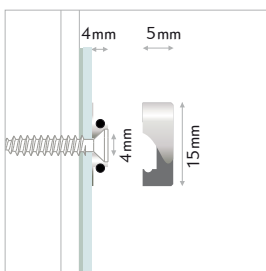
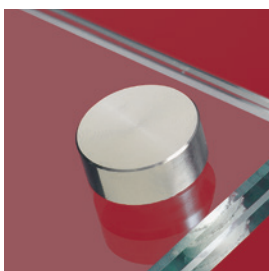

**IT** elegante coprivite a pressione in acciaio di qualità. il pannello si attacca a parete direttamente con il fissaggio micro. fissare il coprivite a pressione e senza utensili direttamente sull'anello. fissaggio: sistema a vite a pressione, montaggio frontale, per luoghi poco accessibili, semplice e veloce. materiale: anellino in ottone, coprivite in inox AISI304.

**DE** hochwertige click-on dekokappe in edelstahl. schilder oder paneele mit dem microhalter direkt an der wand befestigen. die dekokappe aus edelstahl ohne werkzeug einfach auf den halter klicken. befestigung: schraub-klicksystem, frontmontage, für unzugängliche orte. material: messing, AISI304 edelstahl.

**EN** high grade stainless steel click on deco head. mount panels or signs with micro fastener directly on the wall. then simply click the deco head on the fastener, no tools needed, for quick mounting. mounting: screw-clicksystem, frontal mounting, for hard accessible places, quick and easy. material: fastener brass, head AISI304 steel.

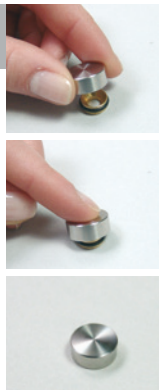

combinations



acciaio | stahl | steel

FMI1500IX

Ø15mm, 40pcs

1box

pz/st/pc

FMI3000IX\*

Ø30mm 40pcs

\* fino ad esaurimento scorta | solange vorrat reicht | while stock last

## steel safe

MADE IN EU design by KD

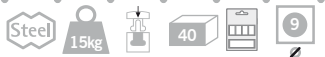
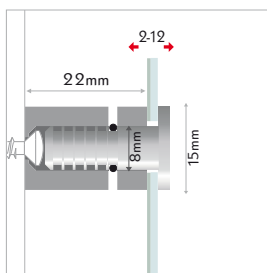
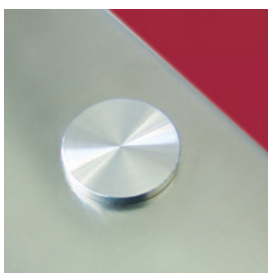

combinations

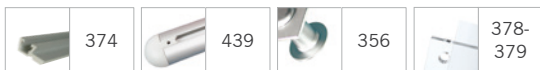

**IT** sistema variabile zigrinato, chiusura di sicurezza, veloce da montare. inserire le testine nel pannello e le rondelle in pvc, montare i distanziali alla parete. premere il pannello con le testine nei fori dei distanziali. inserire la moletta. fissaggio: sistema zigrinato, con chiusura laterale di sicurezza. materiale: acciaio inox o ottone color cromo lucido o argento satinato.

**DE** variables raster-klemmsystem, manipulationsgeschützt, schnell. köpfe durch paneel und pvc-scheibe stecken, hülsen wandmontieren. köpfe einfach aufklicken. metallklemme einschieben. befestigung: raster-klemmsystem, manipulationsicher. material: edelstahl bzw. messing versilbert oder verchromt.

**EN** variable grid-clampsystem, tamper-proof, quickly mounted. put the head through panel and washer, wallmount the spacers. plug the heads into the spacers and insert the spring. mounting: variable grid-clampsystem, tamper-proof. material: stainless steel or brass, silver- or chrome-plated.



acciaio | stahl | steel

FSF1520IX

40pcs

1box

pz/st/pc



## fixxo bond

MADE IN EU design by KD

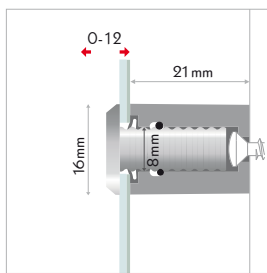

combinations

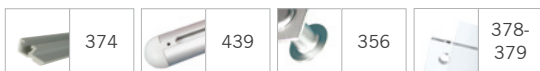

**IT** sistema variabile zigrinato con l'effetto inox. tutti i vantaggi del sistema fixxo. l'inserto in acciaio inox spazzolato fa un effetto speciale e può essere personalizzato con stampa, incisione o adesivo. materiale: nylon color nero satinato, acciaio inox spazzolato.

**DE** variables raster-klemmsystem mit stahl-effekt. alle vorteile des fixxo-systems. durch das edelstahl-inlay im kopf effektvolle optik. inlay kann personalisiert werden (druck, gravur). wetterfest. befestigung: raster-klemmsystem, für unterschiedliche stärken. material: mattschwarzes nylon, gebürsteter edelstahl.

**EN** variable grid-clampsystem with steel-look. all advantages of the fixxo-system. special steel look thanks to the brushed stainless steel inlay, that is customizable (print, engraving). weather-proof. mounting: grid-clampsystem, for different thickness. material: black matt nylon, brushed stainless steel.



acciaio | stahl | steel

FBO1621SZ

40pcs

1box

pz/st/pc

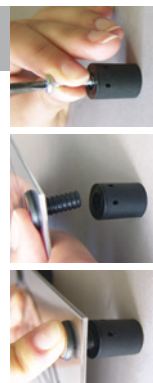

## fixxo steel

MADE IN EU design by KD

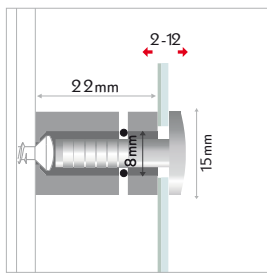
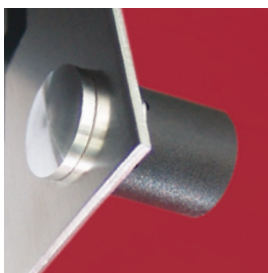

combinations

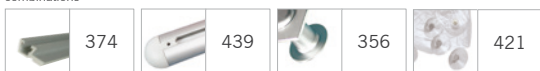

**IT** sistema variabile zigrinato con testina inox. tutti i vantaggi del sistema fixxo. testina in acciaio inox, distanziale in nylon. economico e veloce. fissaggio: sistema zigrinato, per lastre di differenti spessori, materiale: nylon color nero satinato, acciaio inox.

**DE** variables raster-klemmsystem mit edelstahl-kopf. alle vorteile des fixxo-systems. kopf aus edelstahl, hülsen aus kunststoff. befestigung: raster-klemmsystem, für unterschiedliche plattenstärken, material: mattschwarzes nylon, edelstahl.

**EN** variable grid-clampsystem with steel head. all advantages of the fixxo-system. head made of stainless steel, spacer made of nylon. mounting: grid-clampsystem, for different thicknesses. material: black matt nylon, brushed stainless steel.

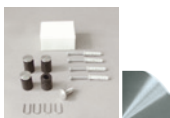

acciaio | stahl | steel

FIXXO1621IX

40pcs

1box

pz/st/pc

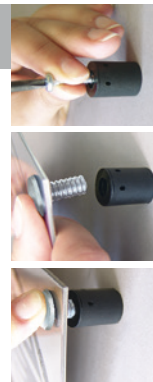



## steel 13

MADE IN EU design by KD

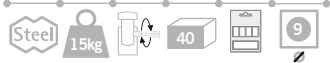
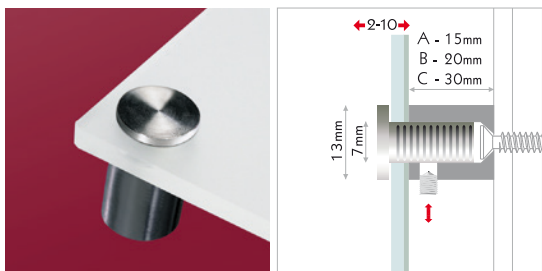

**IT** sistema di fissaggio in acciaio con chiusura laterale di sicurezza per piccoli formati. fissare il distanziale alla parete, posizionare il pannello, inserire la testina nel foro e attraverso il pannello e completare il fissaggio tramite la brugola laterale di sicurezza, che impedisce che la targa possa venir manomessa o smontata. materiale: acciaio inox AISI304, testina con sfaccettature.

**DE** hochwertiger edelstahl, elegante facettenoptik, stecksystem mit manipulationsgeschützter arretierung für kleine formate. halter an der wand befestigen, paneel auflegen, kopf durch das paneel in den halter stecken und mit seitlicher madenschraube im halter gegen manipulation sichern. material: edelstahl AISI304, facetteneffekt.

**EN** high-quality stainless steel, elegant facet appearance, plug-interlocksystem, tamper-proof, for small sizes. mount the fastener to the wall, put on the panel and plug the head through the panel into the fastener. fix the head in the fastener with the allen screw. material: stainless steel AISI304, head with facet cut.



	acciaio   stahl   steel		1box	pz/st/pc
	A: FS1315IX	40pcs		
	B: FS1320IX	40pcs		
	C: FS1330IX	20pcs		



combinations



## steel 15

MADE IN EU design by KD

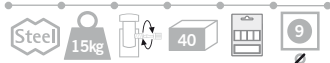
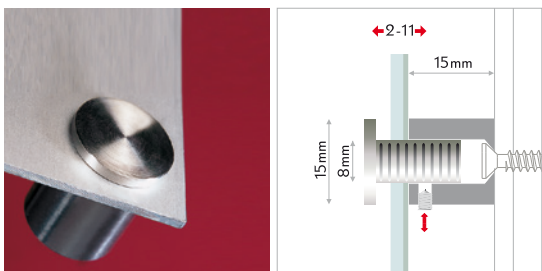

**IT** sistema di fissaggio in acciaio con chiusura laterale di sicurezza per formati piccoli. materiale: acciaio inox AISI304, testina con sfaccettature.

**DE** edelstahl-stecksystem mit manipulationsgeschützter arretierung, für kleinere formate. material: edelstahl AISI304, facetteneffekt.

**EN** stainless steel, plug-interlocksystem for smal sizes, tamper-proof. material: stainless steel AISI304, head with facet cut



	acciaio   stahl   steel		1box	pz/st/pc
	FS1515IX	40pcs		



combinations

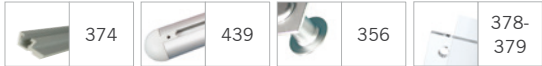

## steel 20

MADE IN EU design by KD

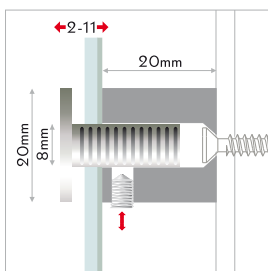

**IT** sistema di fissaggio in acciaio con chiusura laterale di sicurezza per formati medie. materiale: acciaio inox AISI304, testina con sfaccettature.

**DE** edelstahl-stecksystem mit manipulationsgeschützter arretierung, für mittlere formate. material: edelstahl AISI304, facetteneffekt.

**EN** stainless steel, plug-interlocksystem for middle sizes, tamper-proof. material: stainless steel AISI304, head with facet cut

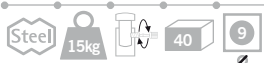

combinations

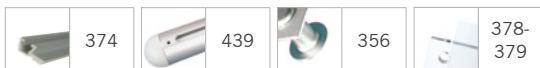

acciaio | stahl | steel

FS2020IX

40pcs

1 box

pz/st/pc

## steel 25

MADE IN EU design by KD

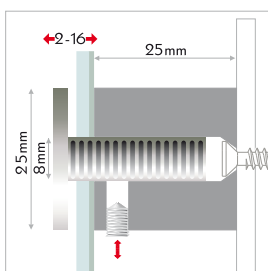
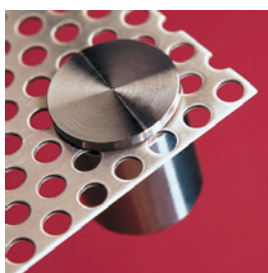

**IT** fissaggio in acciaio con chiusura laterale di sicurezza per formati grandi. materiale: acciaio inox AISI304, testina sfaccettata.

**DE** edelstahl-stecksystem mit manipulationsgeschützter arretierung für grosse formate. material: edelstahl AISI304, facetteneffekt.

**EN** stainless steel, plug-interlocksystem for big sizes, tamper-proof. material: stainless steel AISI304, head facet cut.

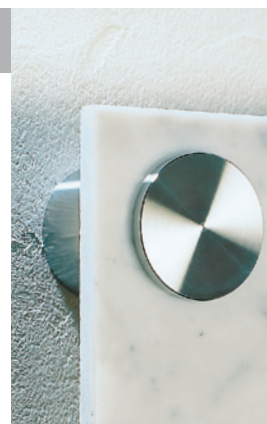

combinations



acciaio | stahl | steel

FS2525IX

20pcs

1 box

pz/st/pc

## steel 50

MADE IN EU design by KD

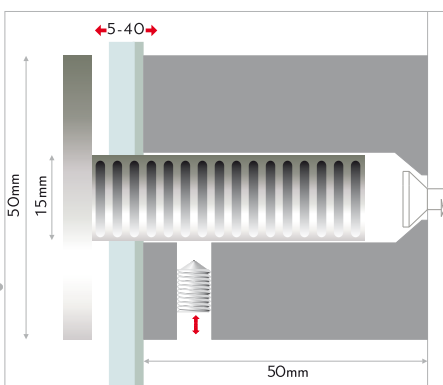
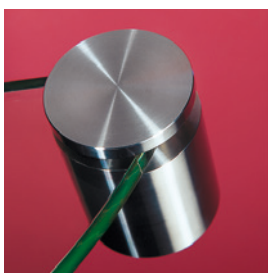

**IT** sistema di fissaggio in acciaio con chiusura laterale di sicurezza per lastre spesse e pesanti. materiale: acciaio inox AISI304, testina con sfaccettature.

**DE** stecksystem mit arretierung, edelstahl mit facettenoptik, für dicke, schwere paneele, manipulationsgeschützt. material: edelstahl AISI304, facetteneffekt.

**EN** plug-interlocksystem, faceted stainless steel for thick and heavy panels, tamper-proof. material: stainless steel AISI304, head facet cut.



combinations

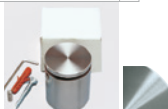

acciaio | stahl | steel

FS5050IX

1pc

pz/st/pc



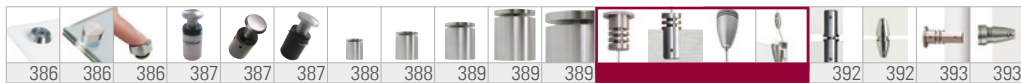

## steel plus

MADE IN EU design by KD

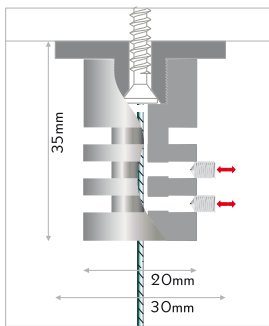
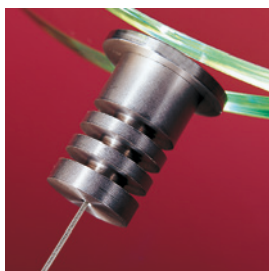

**IT** tirante in acciaio per cavi con sistema a brugola. fissaggio a soffitto universale, in acciaio inox, per cavi di acciaio o di nylon o per catenelle. montare il tirante a soffitto, inserire il cavo nel morsetto e fissarlo con le brugole. fissaggio: tirante per cavi, sistema a brugola. materiale: acciaio AISI303, testina con sfaccettature. distanza dal soffitto: 35mm. spessore del cavo: max. Ø1,8mm.

**DE** edelstahl seilhalter, schraubsystem. universelle deckenbefestigung aus edelstahl für stahlseil, kette oder nyllonschnur. deckenhalter montieren, seil in die klemme schieben und mit madenschraube sichern. befestigung: seilhalter, schraubsystem. material: edelstahl AISI303, facettenschliff. wandabstand: 35mm. seilstärke: max. Ø1,8mm.

**EN** stainless steel cable support, screw system. universal ceiling fastener for cable, chain or nylon thread. mount the fastener, insert the cable into the clamp and fasten with allen screw. mounting: cable support, screw system. material: stainless steel AISI303, facet finish. wall distance: 35mm. cable thickness: max. Ø1,8mm.



combinations

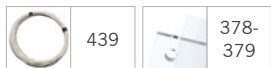

acciaio | stahl | steel

FPS3035IX

10pcs

1 box

pz/st/pc

## steel univers

MADE IN EU design by KD

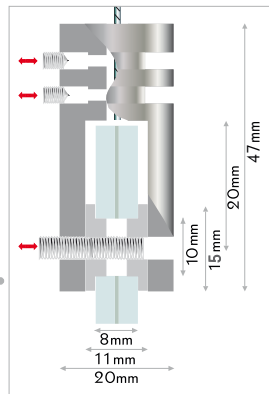

**IT** morsetto in acciaio per pannelli con cavi. morsetto per cavi di acciaio o di nylon o per catenelle. il fissaggio del pannello e del cavo avviene tramite le brugole. anellini di protezione inclusi. fissaggio: morsetto per pannelli, sistema a brugola. materiale: acciaio AISI303, testina con sfaccettature. spessore del pannello: max. 8mm o 11mm senza anellini. spessore del cavo: max. Ø1,8mm.

**DE** edelstahl paneelhalter für seil. halter für stahlseil, kette oder nyllonschnur. befestigung von paneel und seil mit madenschrauben. inklusive glasschutzringe. befestigung: paneelhalter für seil, schraubsystem. material: edelstahl AISI303, facettenschliff. plattenstärke: max. 8mm bzw. 11mm ohne ringe. seilstärke: max. Ø1,8mm.

**EN** stainless steel panel support for cable. panel support for cable, chain or nylon thread. fixing of panel and cable with allen screws. protecting rings included. mounting: panel support, screw system. material: stainless steel AISI303, facet finish. panel thickness: max 8mm resp. 11mm without rings. cable thickness: max. Ø1,8mm.

combinations

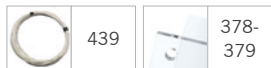

acciaio | stahl | steel

FUS2047IX

10pcs

1 box

pz/st/pc

## steel ceilingmatic

MADE IN EU design by KD

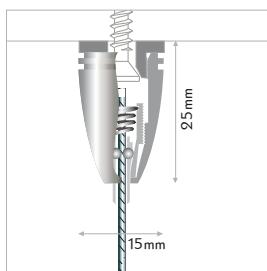

**IT** tirante in acciaio per cavi con sistema autobloccante. fissaggio a soffitto universale per cavi di acciaio o di nylon. montare il tirante a soffitto e inserire il cavo nel morsetto. il meccanismo di autobloccaggio trattiene automaticamente il cavo. fissaggio: tirante per cavi con sistema autobloccante semplice e sicuro. materiale: acciaio AISI303. distanza dal soffitto: 25mm. spessore del cavo: max. Ø1,2mm.

**DE** seilhalter in edelstahl, matic-system. universelle deckenbefestigung für stahlseil oder nyllonschnur. deckenhalter montieren, seil in die klemme schieben. die selbstschliessende mechanik blockiert das seil auf zug. befestigung: seilhalter, matic-system, einfach, genau, sicher. material: edelstahl AISI303. wandabstand: 25mm. seilstärke: max. Ø1,2mm.

**EN** stainless steel cable support, self-locking. universal ceiling fastener for steel cable or nylon thread. mount the fastener, insert the cable. the self-locking mechanism holds the cable by pull. mounting: cable support, self-closing, easy, exact, safe. material: stainless steel AISI303. wall distance: 25mm. cable thickness: max. Ø1,2mm.

combinations

	439		378-379
--	-----	--	---------



acciaio | stahl | steel

FCM1525IX\*

10pcs

1 box

pz/st/pc

\* fino ad esaurimento scorta | solange vorrat reicht | while stock last

## steel pinch

MADE IN EU design by KD

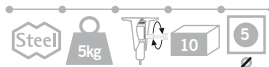
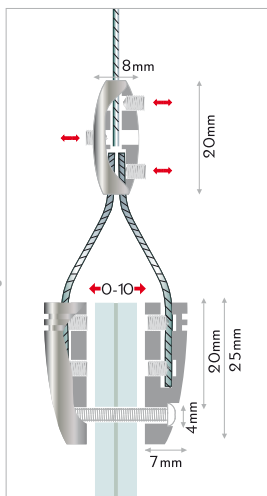

combinations

	439		378-379
--	-----	--	---------

**IT** morsetto variabile in acciaio per pannelli con cavi. morsetto per cavi di acciaio o di nylon o per catenelle. il fissaggio del pannello e del cavo avviene tramite le brugole. fissaggio: morsetto per pannelli, variabile, per diversi spessori, sistema a brugola. materiale: acciaio AISI303. spessore del pannello: max. 10mm. grazie all'utilizzo di brugole più lunghe è possibile fissare anche spessori maggiori. spessore del cavo: max. Ø1,8mm.

**DE** variabler edelstahl paneelhalter für seil. halter für stahlseil, kette oder nyllonschnur. befestigung von paneel und seil mit madenschrauben. befestigung: paneelhalter für seil, variabel für diverse stärke, schraubensystem. material: edelstahl AISI303. plattenstärke: max. 10mm, mehr mit längerer madenschraube. seilstärke: max. Ø1,8mm.

**EN** variable stainless steel panel support for cable. panel support for cable, chain or nylon thread. fixing of panel and cable with allen screws. mounting: panel support, variable fitting different thickness, screw system. material: stainless steel AISI303. panel thickness: max 10mm, more with longer allen screw. cable thickness: max. Ø1,8mm.



acciaio | stahl | steel

FPI0725IX\*

10pcs

1 box

pz/st/pc

\* fino ad esaurimento scorta | solange vorrat reicht | while stock last



## steel union

MADE IN EU design by KD

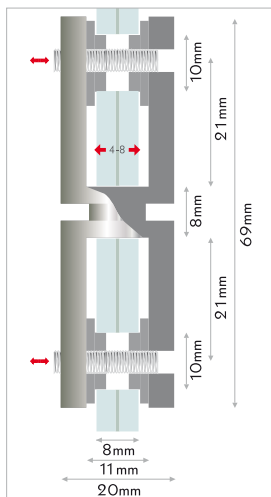
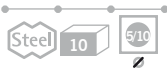
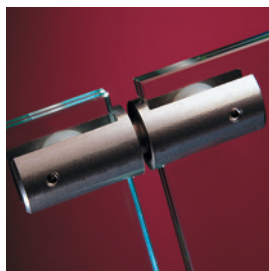

**IT** connettore in acciaio per pannelli. morsetto in acciaio inox per la connessione verticale di pannelli. il fissaggio avviene tramite le brugole. anellini di protezione inclusi. fissaggio: connettore di pannelli. materiale: acciaio inox AISI303

**DE** paneelverbinder aus edelstahl. halter aus edelstahl für die verbindung von paneelen untereinander. befestigung mit madenschrauben, inklusive glasschutzringe. befestigung: paneelverbinder. material: edelstahl AISI303.

**EN** stainless steel panel connector. stainless steel support to connect one panel under the other. fixing of panel with allen screws, protecting rings included. mounting: panel connector. material: stainless steel AISI303.



acciaio | stahl | steel

FNS2069IX\*

10pcs

1box

pz/st/pc

\* fino ad esaurimento scorta | solange vorrat reicht | while stock last

## steel unite

MADE IN EU design by KD

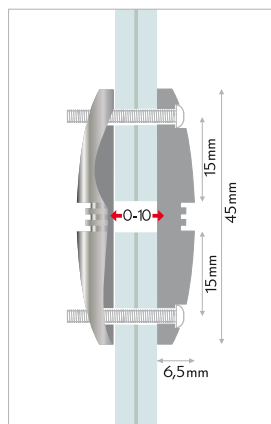

**IT** connettore variabile in acciaio per pannelli. morsetto in acciaio inox per la connessione verticale di pannelli. il fissaggio avviene tramite le brugole. fissaggio: connettore variabile per pannelli con diversi spessori. materiale: acciaio inox AISI303.

**DE** variabler paneelverbinder aus edelstahl. halter aus edelstahl für die verbindung von paneelen untereinander. befestigung mit madenschrauben. befestigung: paneelverbinder, variabel für diverse stärke. material: edelstahl AISI303.

**EN** variable stainless steel panel connector. stainless steel support to connect one panel under the other. fixing of panel with allen screws. mounting: panel connector, variable fitting different thickness. material: stainless steel AISI303.

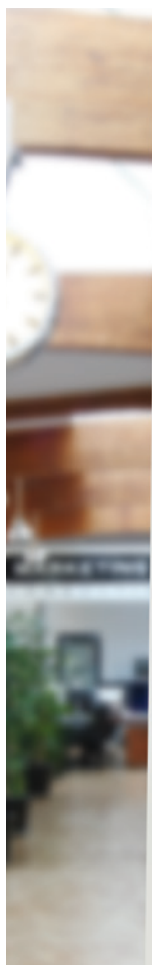

acciaio | stahl | steel

FUT0745IX\*

10pcs

1box

pz/st/pc

\* fino ad esaurimento scorta | solange vorrat reicht | while stock last

## steel uniplus

MADE IN EU design by KD

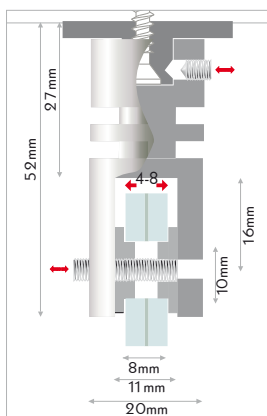

**IT** morsetto variabile a bandiera in acciaio per parete o soffitto. per montaggi di pannelli a bandiera o direttamente a soffitto. il fissaggio del pannello avviene tramite le brugole. fissaggio: morsetto variabile a bandiera con sistema a brugola. materiale: acciaio inox AISI303.

**DE** variabler edelstahl paneelhalter für wand/decke. für direkte wand- oder deckenmontage von auslegern und fahnschildern. befestigung des paneels mit madenschrauben. befestigung: paneelhalter für wand/decke, variabel für diverse stärken, schraubsystem. material: edelstahl AISI303.

**EN** variable panel support for wall/ceiling. for wall- or ceilingmounted flagsigns. fixing of the panel with allen screws. mounting: panel support for wall/ceiling, screw system, variable fitting different thickness. material: stainless steel AISI303.



acciaio | stahl | steel

FUPS3052IX

10pcs

1 box

pz/st/pc

## steel wallpinch

MADE IN EU design by KD

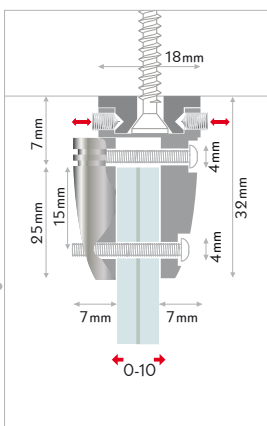

**IT** morsetto variabile a bandiera in acciaio per parete o soffitto. per montaggi di pannelli a bandiera o direttamente a soffitto. il fissaggio del pannello avviene tramite le brugole. fissaggio: morsetto variabile a bandiera con sistema a brugola. materiale: acciaio inox AISI303.

**DE** variabler edelstahl paneelhalter für wand/decke. für direkte wand- oder deckenmontage von auslegern und fahnschildern. befestigung des paneels mit madenschrauben. befestigung: paneelhalter für wand/decke, variabel für diverse stärken, schraubsystem. material: edelstahl AISI303.

**EN** variable panel support for wall/ceiling. for wall- or ceilingmounted flagsigns. fixing of the panel with allen screws. mounting: panel support for wall/ceiling, screw system, variable fitting different thickness. material: stainless steel AISI303.



acciaio | stahl | steel

FWP0732IX\*

10pcs

1 box

pz/st/pc

\* fino ad esaurimento scorta | solange vorrat reicht | while stock last

## fisso sintetici

**IT** soluzioni convenienti in materiale plastico per il fissaggio di pannelli leggeri: per tutte le applicazioni dai coprivite ai distanziali, dal policarbonato al nylon, nascosti oppure visibili.

## fisso kunststoff

**DE** günstige lösungen aus kunststoff zur befestigung leichter materialien: für alle anwendungen von der abdeckkappe bis zum distanzhalter, von polycarbonat bis nylon, verdeckt oder sichtbar.

## fisso synthetics

**EN** good value fasteners in synthetics for light-weight material: for all applications from caps to spacers, from polycarbonate to nylon, visible or blind mounted.



							
micro plast	tube	klipser	fixxo	ghost	panel connector	x-man	pixfix
396	396	396	397	398	398	399	400

			
pixfix safe	con	digiplug	connector
401	402	403	403

# micro plast

MADE IN EU design by KD

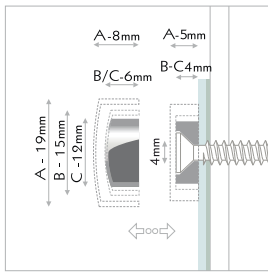

**IT** conveniente coprivite a pressione. montaggio diretta a parete. fissare il coprivite a pressione direttamente sull'anellino. fissaggio: sistema a vite a pressione, montaggio frontale, per luoghi poco accessibili. materiale: materiale plastico colorato.

**DE** preisgünstiges Klicksystem. direkte wandmontage, micro dekokappe einfach aufklicken. befestigung: frontales schraub-klicksystem. material: kunststoff farbig.

**EN** budget-priced fastener with click system. direct wallmounting, simply click the micro head on the fastener. mounting: frontal screw-clicksystem, material: coloured synthetics.

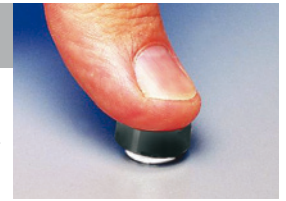

Sy 15kg 80 5  
Ø12mm



nero   schwarz   black		1box	pz/st/pc
FMISY1000SZ	Ø12mm, 80pcs		
FMISY1500SZ	Ø15mm, 80pcs		
bianco   weiss   white		1box	pz/st/pc
FMISY1000WE	Ø12mm, 80pcs		
FMISY1500WE	Ø15mm, 80pcs		

combinations

396	378-379
-----	---------

# tube

MADE IN EU design by KD

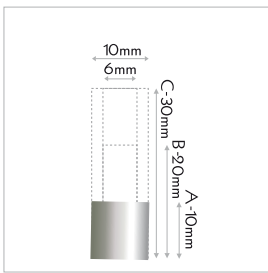
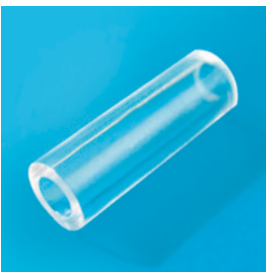

**IT** distanziale in acrilico. bussole per viti in acrilico di 2mm di spessore, convenienti e robuste. fissaggio: distanziale a bussola per tutti gli usi. materiale: acrilico trasparente.

**DE** abstandshülse, acryl. preisgünstige und robuste schraubenhülse in 2mm starkem acryl. universell verwendbar. material: transparentes acryl.

**EN** sleeve, acrylic. budget-priced and robust screw sleeve made of 2mm thick acrylic. mounting: screw sleeve, all-purpose. material: transparent acrylic.



Sy 100

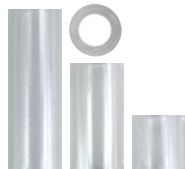

combinations

352	353
-----	-----

trasparente   transparent   transparent		1box	pz/st/pc
FTU1010	10mm, 100pcs		
FTU1030*	30mm, 100pcs		

\* fino ad esaurimento scorte | solange vorrat reicht | while stock last

# klipser

MADE IN EU design by KD

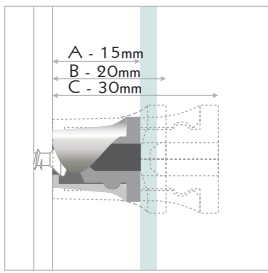

**IT** sistema di fissaggio a pressione, da incollare, invisibile, senza fori. fissare la bussola a parete, incollare la testina al pannello con biadesivo, silicone o colla, agganciare il pannello alla bussola. materiale: acrilico bianco/trasparente.

**DE** klebe-klicksystem, versteckt, ohne lochbohrung. hülse wandmontie-ren. material mit silikon, doppel- oder flüssigkleber direkt auf dem kopf befestigen. panel einklicken. material: acryl weiss/transparent.

**EN** glue-clicksystem, invisible, no holes. wallmount the spacer. fix the panel with adhesive tape, silicone or superglue directly to the head. click in the panel. material: acrylic, white/transparent.



Sy 477



trasparente   transparent   transparent		1box	pz/st/pc
FKL1515	15mm, Ø15mm, 100pcs		
FKL2020	20mm, Ø20mm, 50pcs		
FKL2030	30mm, Ø20mm, 50pcs		

477 manual

fixxo

patented

MADE IN EU design by KD

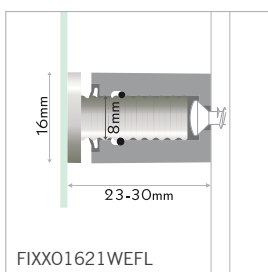
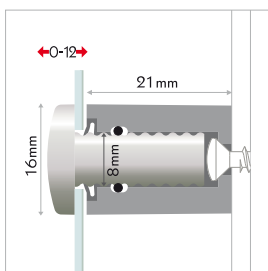

FIXXO1621WEFL



fixxo in colore bianco con la testa piatta (FIXXO1621WEFL) per montaggi invisibili di pannelli senza fori.

fixxo weiss mit flachkopf (FIXXO1621WEFL) für die unsichtbare montage ohne lochbohrung.

fixxo white with a flat head (FIXXO1621WEFL) for invisible mounting without holes.

combinations

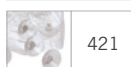
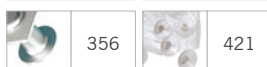

**IT** sistema variabile zigrinato. fissare il distanziale alla parete, posizionare il pannello, premere la testina nel foro e attraverso il pannello. le lamelle elastiche e sottili assicurano un fissaggio perfetto del pannello. la molletta laterale in acciaio blocca la testa del distanziale ed impedisce che la targa possa venir manomessa. fixxo in colore bianco è disponibile anche con la testa piatta (FIXXO1621WEFL) per montaggi invisibili di pannelli senza fori: incollare la testina direttamente al pannello con biadesivo, silicone o colla a due componenti. materiale: policarbonato o nylon cromato. distanza dalla parete: 21mm. spessore del pannello: fino a max 12mm.

**DE** variables raster-klemmsystem. abstandhalter wandmontieren, kopf durch das paneel schieben und im distanzer einrasten. elastische plättchen sorgen für satte auflage des paneels. manipulationsschutz durch seitlich einschiebbare edelstahlfeder. fixxo weiss erhältlich mit flachkopf (FIXXO1621WEFL) für die unsichtbare montage ohne lochbohrung: material mit doppel-, silikon- oder 2-komponenten-kleber direkt auf dem kopf befestigen. material: transparentes polycarbonat bzw. farbiges oder verchromtes nylon. wandabstand: 21mm. plattenstärke: bis max.12mm.

**EN** variable grid-clampsystem. wallmount the spacer, put the head through the panel and snap in the spacer. elastic small plates keep the panel solid seated. retractable stainless steel spring prevents from manipulation. fixxo white is available also with a flat head (FIXXO1621WEFL) for invisible mounting without holes: fix the panel with adhesive tape, silicone or superglue directly on the fixxo head. material: transparent polycarbonate resp. coloured or plated nylon. wall distance: 21mm. sign thickness: up to 12mm.

	nero satinato   schwarz matt   black matt	1 box	pz/st/pc
	FIXXO1621MSZ	40pcs	
	grigio satinato   grau matt   grey matt		
	FIXXO1621GR	40pcs	
	color vetro   glasgrün   glassgreen		
	FIXXO1621GG	40pcs	
	bianco   weiss   white		
	FIXXO1621WE	40pcs	
	FIXXO1621WEFL	40pcs	







# ghost patented

MADE IN EU design by KD

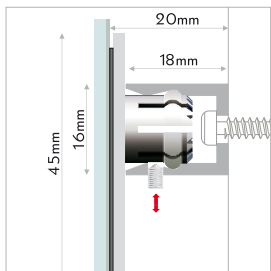

**IT** il distanziale invisibile e semplice da montare. per tutti i casi in cui non siano graditi i distanziali visibili e quando si debba o si voglia rinunciare a forare la targa. posizionare sulla targa i distanziali in polycarbonato e fissarli nella parte posteriore; marcare sulla parete i punti da forare con i piccoli biadesivi e avvitare alla parete i distanziali in nichel; agganciare la targa al muro esercitando una lieve pressione. materiale: polycarbonato, ottone nichelato.

**DE** unsichtbare befestigung mit montagehilfe. immer wenn sichtbare halter unerwünscht sind und sie auf löcher verzichten müssen oder wollen. polycarbonathalter mit den randabstandsbugeln positionieren, auf der schildrückseite befestigen, bohrlöcher mit den doppelklebern an der wand ganz einfach markieren, wandhülsen andübeln und das schild einklicken. material: polycarbonat, messing vernickelt.

**EN** invisible fastener with fit-up aid. when you want to hide the fastener and you cannot or will not have holes in your sign. post the polycarbonate fastener using the removable leaves on your sign, fasten it with screws, glue, tape or silicone, mark the boreholes on the wall using the smart adhesive stickers, wallmount the spacers and click in the sign. material: polycarbonate, brass nickel-plated.



- ⚠** si prega di verificare se l'applicazione scelta è adatta per materiale e peso. quando si sceglie il montaggio con adesivi seguire le istruzioni del manuale rigorosamente.
- ⚠** unbedingt testen, ob sich ihre gewählte anwendung für material und gewicht eignet. v.a. wenn sie befestigung mit klebstoffen wählen, befolgen sie die bedienungsanleitung.
- ⚠** every application must be tested if suitable for material and weight, esp. when using adhesives follow manual instructions carefully.

combinations

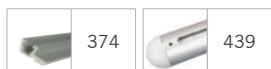

ghost   ghost   ghost	1box	pz/st/pc
<b>FG4618K</b>	20pcs	

# panel connector

MADE IN EU design by KD

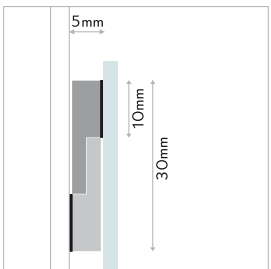
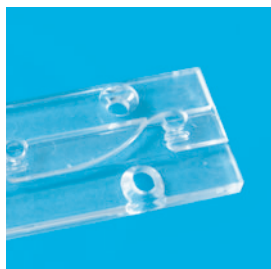

**IT** binario di fissaggio laterale da incollare, invisibile. montare una parte a parete, l'altra incollarla con biadesivo, silicone o colla sul pannello. fissaggio con viti anche possibile. i pannelli sono così facilmente intercambiabili. materiale: acrilico trasparente.

**DE** einerschub-schiene zum kleben, unsichtbar. ein teil wandmontieren, den anderen mit doppelkleber, silikon oder zwei-komponenten-kleber auf dem pannel befestigen. schrauben-montage auch möglich. pannel aufdrücken, fertig. jederzeit abnehmbar. material: kunststoff transparent.

**EN** slide-in rail, invisible. mount one part to the wall the other on the panel with double adhesive tape, silicone or superglue, fixing with screws also possible. press on the panel, ready. panels can be taken off anytime. material: transparent synthetics.

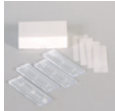

trasparente   transparent   transparent	1box	pz/st/pc
<b>FPC20100</b>	20pcs	

# x-man

MADE IN EU design by KD

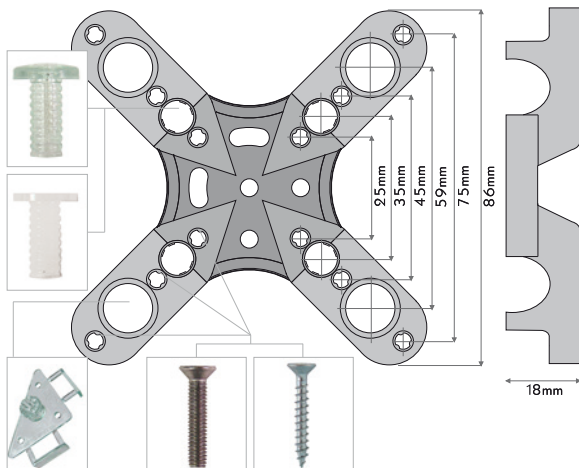

fissaggio di pannelli con viti.  
*panelbefestigung mit schrauben.*  
**panel mounting with screws.**

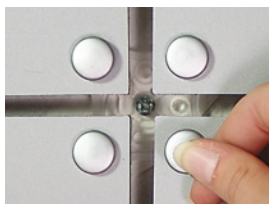

fissaggio di pannelli con il distanziale zigrinato fixxo.  
*panelbefestigung mit fixxo klücksystem.*  
**panel mounting with fixxo click-in.**

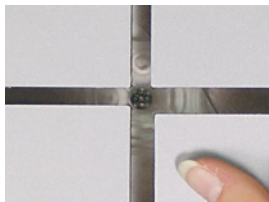

fissaggio invisibile di pannelli con ghost oppure con fixxo (FIXXK16WEFL).  
*unsichtbare panelbefestigung mit ghost oder fixxo (FIXXK16WEFL).*  
**invisible panel mounting with ghost or fixxo (FIXXK16WEFL).**

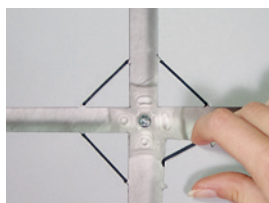

fissaggio dei pannelli con anellini di silicone.  
*panelbefestigung mit silikon-ringen.*  
**panel mounting with silicone oring.**

**IT** x-man: un talento nascosto. per il fissaggio di rivestimenti, pannelli, sistemi di informazione e molto di più. il fissaggio può essere visibile o invisibile, con viti, viti truciolori o con colla, fisso o rimovibile. ideale per luoghi di ingresso con molti pannelli o per pareti mobili. x-man può essere montato centralmente o su un angolo. a seconda delle esigenze x-man può essere usato in combinazione con i nostri distanziali e accessori. fissaggio: attacco a parete per viti, colla o a pressione. materiale: acrilico trasparente. nota bene: si prega di verificare se l'applicazione scelta è adatta per materiale e peso.

**DE** x-man: das multitalent im hintergrund. für die befestigung von verkleidungen, paneelen, informationssystemen und vielem mehr. befestigung sichtbar oder unsichtbar, mit schraube, holzschraube oder kleber, zum abnehmen oder fix montiert. ideal für eingangsbereiche mit vielen schildern oder für mobile wände. x-man kann zentriert oder auf eck montiert werden. kombinieren sie x-man je nach bedarf mit unseren abstandhaltern und montagehilfen. befestigung: wandhalterung zum schrauben, kleben oder klicken. material: kunststoff, transparent. wichtiger hinweis: bitte testen sie die gewählte anwendung vorab auf eignung für material und gewicht.

**EN** x-man: allrounder in the background. for mounting of panelings, panels, information systems and much more. fastening is visible or invisible, with screw, woodscrew or glue, removable or fix. perfect for lobbies with a lot of signs or for mobile walls. you can mount x-man centered or on the corner. combine x-man according to your needs with our spacers and fit-up aids. mounting: wall holder for screwing, gluing or clicking. material: transparent synthetic. important note: please test in advance the choosen application if suitable for material and weight.

combinations



374

439



chiaro | klar | clear

**FXMAN1885**

2pcs

1box

pz/st/pc



col. vetro | glasgrün | glassgreen

**FIXXK16GG**

40pcs



bianco | weiss | white

**FIXXK16WEFL**

40pcs



chiaro | klar | clear

**FGK4618K**

20pcs



# pixfix 100x100

MADE IN EU design by KD

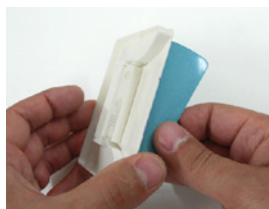
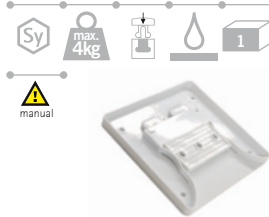
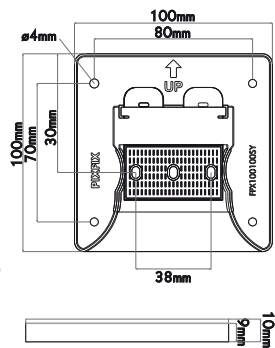
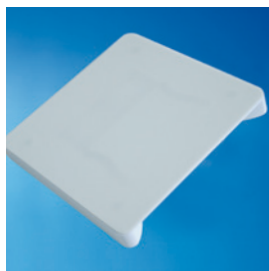

rimuovere il foglio di protezione del biadesivo  
*doppelkleberfolie abziehen*  
**remove adhesive tape foil**

**IT** pixfix vi entusiasmerà: il vostro pannello può essere fissato a parete in modo completamente invisibile e senza essere forato. grazie all'intelligente sistema di inserimento, i pannelli possono inoltre venir cambiati in qualsiasi momento. pixfix può essere fissato alla targa da esporre già direttamente in officina, così da risparmiare tempo sul luogo del montaggio. le dime per il montaggio sono davvero pratiche: si segnano così sul muro i punti dove effettuare i fori con il trapano, senza bisogno di prendere altre misure a vuoto. pixfix si adatta a tutti i materiali perchè può anche essere fissato ai pannelli con delle viti. distanza dal muro: 10mm.



incollare pixfix al pannello  
*pixfix am panel aufkleben*  
**mount pixfix to the panel**

**DE** pixfix wird sie begeistern: ganz ohne lochbohrung und unsichtbar wird ihr panel befestigt. dank des cleveren einschubsystems können sie die paneele auch jederzeit ganz einfach austauschen. die befestigung von pixfix am panel kann bereits in der werkstatt erfolgen, so sparen sie zeit bei der montage. praktisch die montageschablone: bohrlöcher werden einfach durch andrücken markiert, ohne umständliches ausmessen. pixfix ist geeinet für alle materialien und lässt sich auch mit schrauben am panel befestigen. wandabstand: 10mm

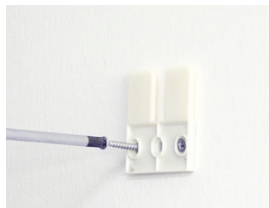

rimuovere la parte di pixfix che va a parete e montarla  
*wandhalter abnehmen und wandmontieren*  
**mount the wall support to the wall**

**EN** pixfix will inspire you: without the need for holes in your panel and it secures it invisibly. thanks to the clever insert system you can simply exchange the panels at anytime. you can mount pixfix to your panels already in the work shop, saving time on-site later. the label positioning is convenient: press on the pixfix and drill holes which are simply marked on the wall. pixfix is suitable for all materials and can be also mounted with screws to the panel. distance from wall: 10mm

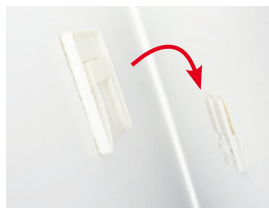

inserire il pannello sul supporto a parete montato in precedenza  
*panel einfach auf wandhalter einklicksen*  
**simply click in your panel**



**⚠** si prega di verificare se l'applicazione scelta è adatta per materiale e peso. quando si sceglie il montaggio con adesivi seguire le istruzioni del manuale rigorosamente.

**⚠** unbedingt testen, ob sich ihre gewählte anwendung für material und gewicht eignet. v.a. wenn sie befestigung mit klebstoffen wählen, befolgen sie die bedienungsanleitung.

**⚠** every application must be tested if suitable for material and weight, esp. when using adhesives follow manual instructions carefully.



pixfix  
**FPX100100SY**

pz/st/pc

1 pc

# pixfix safe 150x200

MADE IN EU design by KD

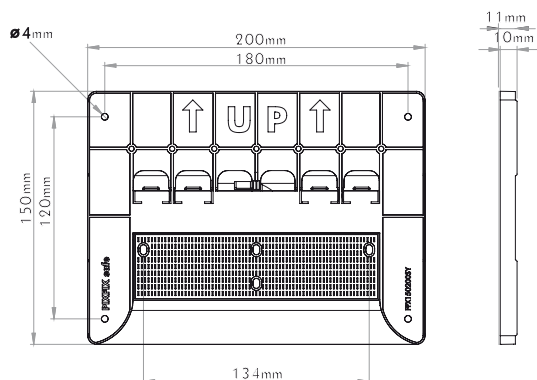
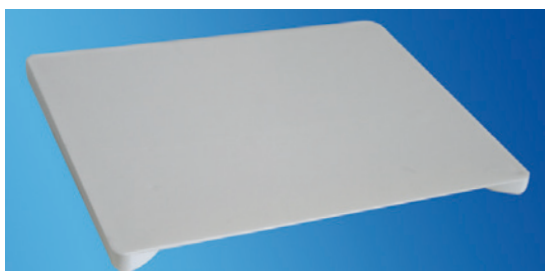

intelligente sistema a prova di furto  
clevere diebstahlsicherung  
thief-proof design



**IT** con il grande pixfix safe facciamo un grosso salto in avanti: adesso potrete fissare a parete senza doverle forare e con un sistema invisibile anche targhe e pannelli di grandi dimensioni. I pannelli possono essere incollati o avvitati al sistema di fissaggio. il clou: un sistema integrato di chiusura, di sicurezza, può essere attivato, a scelta, dopo il montaggio. in questo modo la vostra targa è a prova di furto. la calamita per tale uso è da ordinare separatamente.

**DE** mit dem grossen pixfix safe gehen wir einen schritt weiter: grosse platten befestigen sie damit unsichtbar und ohne lochbohrung. paneele können aufgeklebt oder aufgeschraubt werden. der clou: eine eingebaute sperre kann nach montage optional aktiviert werden. ihr panel ist damit manipulationsgeschützt und diebstahlsicher montiert. bestellen sie hierzu extra den passenden magneten.

**EN** with the bigger pixfix safe we go one step further: big panels can be mounted invisibly and without any holes. panels can be fixed with adhesive tape, glue or screws. the chief attraction: an integrated lock can be optionally activated after mounting easily. thus your panel is tamper- and thief-proof mounted. order the matching magnet extra.

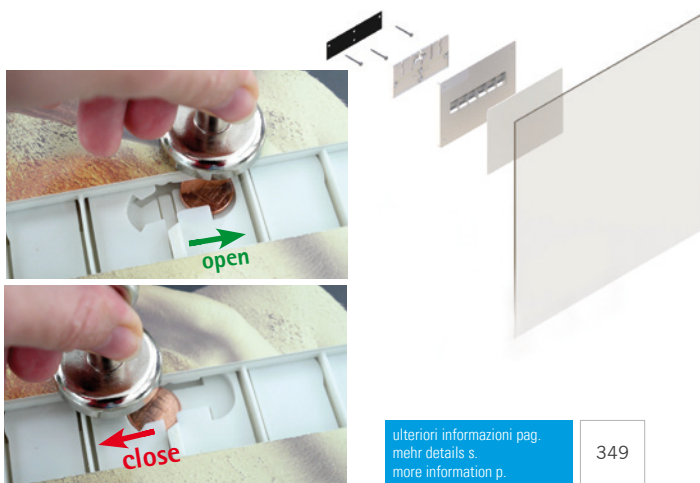

ulteriori informazioni pag.  
mehr details s.  
more information p.

349

⚠ si prega di verificare se l'applicazione scelta è adatta per materiale e peso. quando si sceglie il montaggio con adesivi seguire le istruzioni del manuale rigorosamente.

⚠ unbedingt testen, ob sich ihre gewählte anwendung für material und gewicht eignet. v.a. wenn sie befestigung mit klebstoffen wählen, befolgen sie die bedienungsanleitung.

⚠ every application must be tested if suitable for material and weight, esp. when using adhesives follow manual instructions carefully.



pixfix safe

FPX150200SY

1pc

pz/st/pc

magnet

ACALPF

magnet, 1pc

pz/st/pc

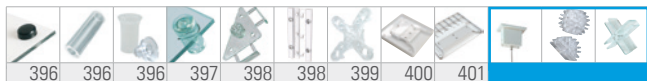

con

MADE IN EU design by KD

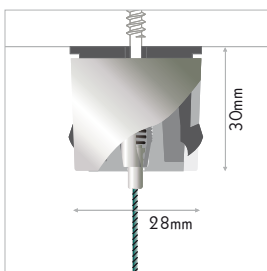

fissare il tirante a soffitto  
halter deckenmontieren  
mount the support to the ceiling

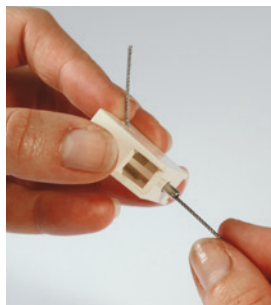

inserire il cavo nel sistema matic  
seil duch den matic-verschluss  
einziehen  
insert the cable through the self-lock  
system



agganciare il fermacavo  
seilhalter aufklipsen  
clip on the cable support



il fermacavo può essere rimosso in  
qualsiasi momento  
seilhalter kann einfach jederzeit  
wieder entfernt werden  
cable support can be removed easily  
anytime



**IT** fermacavo per montaggi a soffitto con sistema matic di chiusura in materiale plastico. fissare il tirante a soffitto, inserire il cavo, agganciare ed il gioco è fatto. Fissaggio: fermacavo con sistema matic; distanza dal soffitto: 28mm, spessore del cavo: max. ø1,8mm

**DE** seilhalter für deckenmontage mit matic schnellverschluss aus kunststoff. halter deckenmontieren, seil montieren, aufklipsen, fertig. befestigung: seilhalter maticsystem, abstand: 28mm, seilstärke max. ø1,8mm

**EN** synthetic cable support for ceiling with matic locksystem. mount the support to the ceiling, fix the cable, clip on the cable support. mounting: cable support, self-closing, wall distance: 28mm, cable thickness: max. ø1,8mm.

combinations

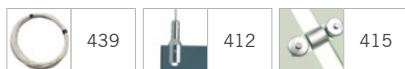

con  
FCN2928 20pcs 1box pz/st/pc

# digiplug

MADE IN CHINA quality control by KD

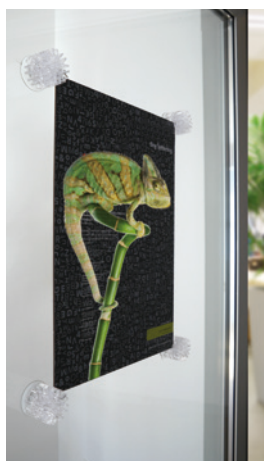

ulteriori informazioni pag.  
mehr details s.  
more information p.

170

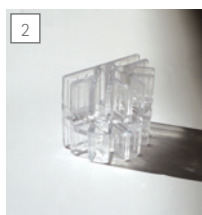
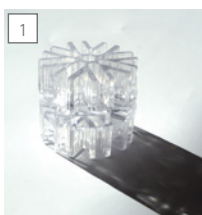

**IT** leggero, facile da usare, veloce da installare: ecco digiplug, il connettore ad 8 vie per pannelli con spessore di 4 mm. digiplug è particolarmente consigliato con pannelli leggeri, di piccole dimensioni e quadrati, perchè il connettore si monta sugli angoli, non in mezzo. digiplug da un lato è filettato, per consentirne l'utilizzo con tutta una serie di accessori. Vi offriamo digiplug come set completo fornito in un a pratica valigetta per il trasporto o a singoli componenti.

**DE** schnell leicht und einfach: das ist digiplug 8-wege verbinder für 4mm starke paneele. besonders empfiehlt sich digiplug mit kleinformatigen, quadratischen leichtstoffplatten, da digiplug an den ecken, nicht mittig, eingesetzt wird. jeder digiplug hat an einer seite ein gewinde für die befestigung von zubehör. wir bieten ihnen digiplug als kompletset im praktischen transportkoffer oder als einzelkomponente an.

**EN** quick, light and easy: this is digiplug, the 8-way connector for 4mm panels. especially recommended is digiplug with small sized, squared lightweight panels as the connector is used at the corners, not in the middle. every digiplug comes with a thread on one side for mounting the accessories. we offer digiplug as a complete set with handy transport case or as single components.

			pz/st/pc
1	DPLU8TR	digiplug full, transparent, 1pc	
2	DPLU5TR	digiplug half, transparent, 1pc	
3	DPLUREG	digiplug regulator, 1pc	
4	DPLUAVEN	digiplug suction cup, 1pc	
5	DPLULMP	digiplug lamp, 1pc	

# connector

MADE IN TAIWAN quality control by KD



**IT** sistema modulare per vetrine ad incastro. realizzate la vostra personalissima vetrina con pannelli da 5mm ed i fissaggi angolari connector in policarbonato color vetro. a seconda della forma e delle dimensioni della vostra applicazione, ordinate i singoli pezzi che vi servono. gli esempi qui riproposti vi aiutano nella scelta del fissaggio giusto.

**DE** schlagfeste eckverbinder aus glasgrünem polycarbonat für cuben nach dem baukasten-system. gestalten sie ihre persönliche vetrine mit connector eckhaltern und 5mm-paneeelen. die beispieldisken helfen Ihnen bei der richtigen auswahl der entsprechenden eckverbinder.

**EN** shock-resistant panel-connector made of glassgreen polycarbonate for modular cube systems. create your personal vetrine with 5mm-panels and connectors. the drawings with examples help you choosing the right parts.

ulteriori informazioni pag.  
mehr details s.  
more information p.

172

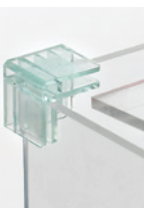
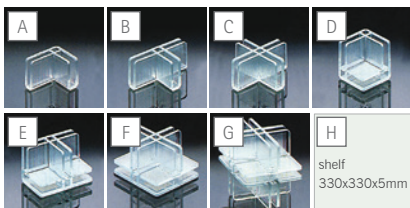

			pz/st/pc
A	FCONA		1pc
B	FCONB		1pc
C	FCONC		1pc
D	FCOND		1pc
E	FCONE		1pc
F	FCONF		1pc
G	FCONG		1pc
H	FCON330PL	shelf, transparent acrylic, 330x330x5mm	

## fisso soffitto e bandiera

**IT** tutto ciò che occorre per montare pannelli informativi a soffitto o a bandiera: tiranti per il fissaggio con catenelle o cavi di acciaio, distanziali a parete per pannelli espositivi o a bandiera, in ottone finemente lavorato o in acciaio inox di qualità, per l'interno e per l'esterno.







## fisso decke und fahne

**DE** alles um infoträger abgehängt oder als fah-nenschild zu befestigen: halter für die abhängung mit seil oder kette, wandhalter für ausleger- und fah-nenschilder, aus veredeltem messing oder rostfreiem, hochwertigem stahl, für innen und aussen.









## fisso ceiling and flagsigns





**EN** everything to mount signs suspended or as flagsigns: fasteners for suspension with cable or chain, wall spacers for flagsigns, made of plated brass or stainless highquality steel, for in- and outdoor.



							
ceiling style	plus	plusmatic	con	fix	plusmini	plusdesign	loop
406	408	408	409	410	410	410	411

							
steel plus	steel univers	steel ceiling-matic	steel pinch	univers	universdesign	perla	lasso
411	411	412	412	412	413	413	413

							
hook	univers mini	univers matic	union design	steel union	steel unite	uniplus	uniplus style
414	414	414	415	415	415	416	416

			
steel uniplus	steel wall pinch	punto	button
416	417	417	417



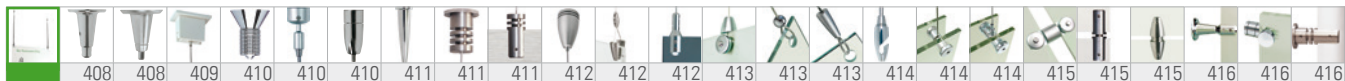

## ceiling style

MADE IN EU design by KD



**IT** style, sistema di informazioni modulare a soffitto. regolare le astine di Ø6mm secondo la lunghezza desiderata. grazie alla combinazione dei 2 diversi formati (300mm e 400mm), è possibile variarne la lunghezza a piacere, a partire da 600mm e in passi da 100mm. le astine dispongono di un filetto M4 e di brugole. finire il montaggio con i tiranti a soffitto e le chiusure finali. i pannelli si montano frontalmente o di lato, grazie alla scelta dei distanziali. lunghezza e larghezza del sistema sono variabili grazie alla modularità degli elementi. ideale per pannelli singoli come anche a sandwich, mono e bifacciali. fissaggio: sistema a brugola, per montaggi frontali e laterali. materiale: ottone cromato lucido. spessore del pannello: max 10mm, spessori maggiori con brugole piú lunghe. foro del pannello: Ø4mm.

**DE** style, modulares infosystem für die decke. die Ø6mm stangen je gewünschter länge verschrauben. durch kombination der zwei längen (300mm und 400mm) sind ab 600mm alle längen in 100mm-schritten möglich. stangen miteinander verschrauben und mit endkapen und deckenhalter montieren. frontale oder seitliche montage je nach halter. länge und breite erweiterbar durch modulare bauweise. für einzelpanelee wie sandwichsysteme auch beidseitig. befestigung: schraubensystem, frontale und seitliche montage. material: messing verchromt. plattenstärke: max. 10mm, mehr mit längerer madenschraube. lochbohrung: Ø4mm.

**EN** style, modular information system, ceilingmounted. according to your needed length, screw the Ø6mm bars together. by combining the two lengths (300mm and 400mm) starting from 600mm all heights in 100mm-steps are possible. screw the bars together and mount them with endcaps and ceiling support. lateral or frontal mounting of the panels. enlarge height and width of the modular system anytime. suitable for single panels as well as sandwich systems, also both-way. mounting: screw system, frontal and lateral mounting. material: brass chrome-plated. panel thickness: max. 10mm, more with longer allen screw. panel hole: Ø4mm.



1	ASTA	cromo   chrom   chrome	1box	pz/st/pc
	YWS3006CM	300mm, 2pcs		
2	YWS4006CM	400mm, 2pcs		
2	CIMA	cromo   chrom   chrome		
	YWS1008CM	40pcs		
3	FORTE	cromo   chrom   chrome		
	YCS1529CM	10pcs		
4	AMO	cromo   chrom   chrome		
	YCS1535CM	10pcs		
5	LATO	cromo   chrom   chrome		
	YWS1545CM	40pcs		
6	CUPIDO	cromo   chrom   chrome		
	YWS1568CM	10pcs		
7	PROFI	cromo   chrom   chrome		
	YCS1527CM	40pcs		
8	MAESTRO	cromo   chrom   chrome		
	YWS1525CM	40pcs		

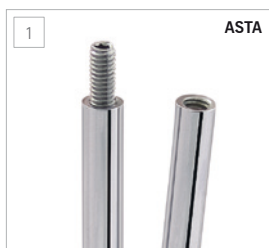

combinations

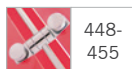

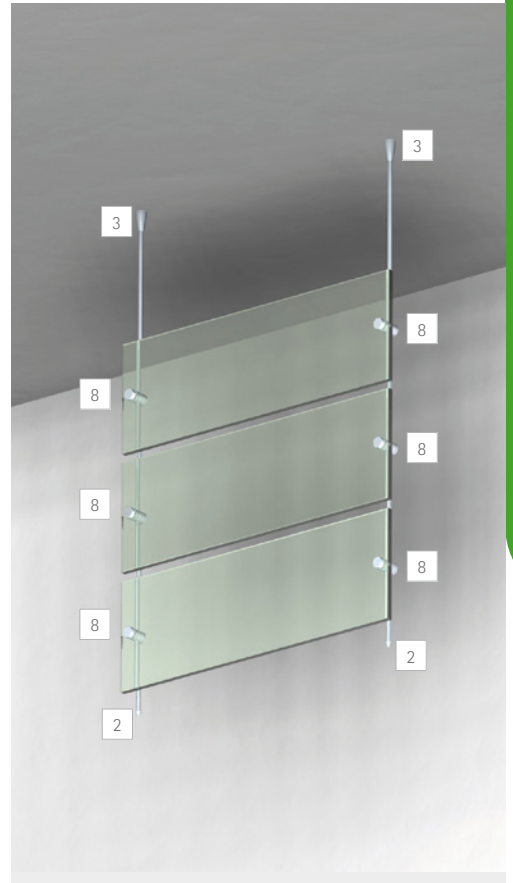
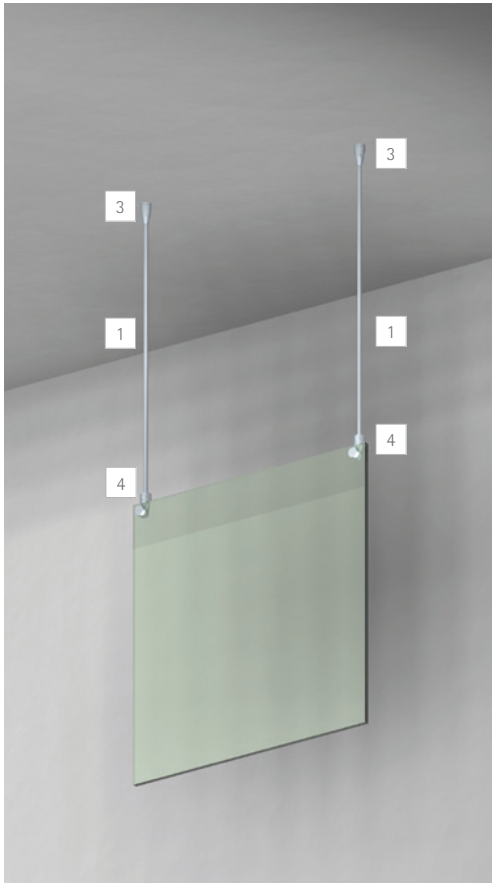
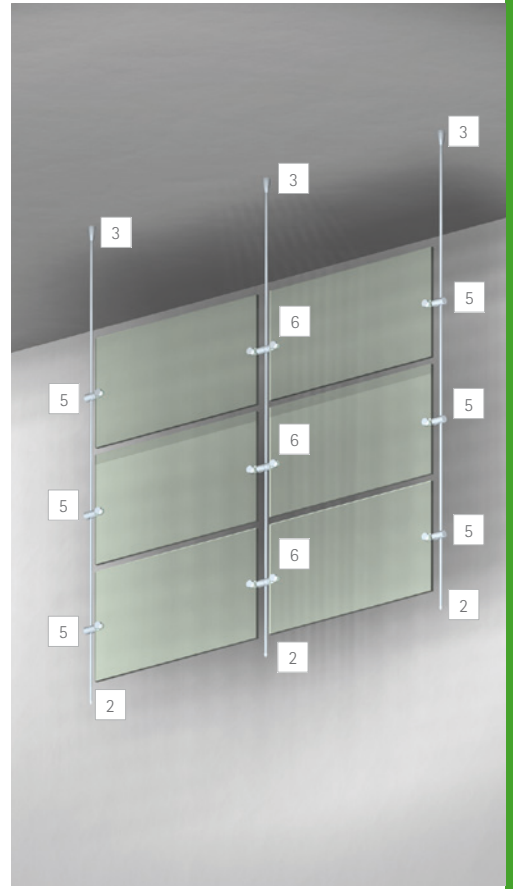
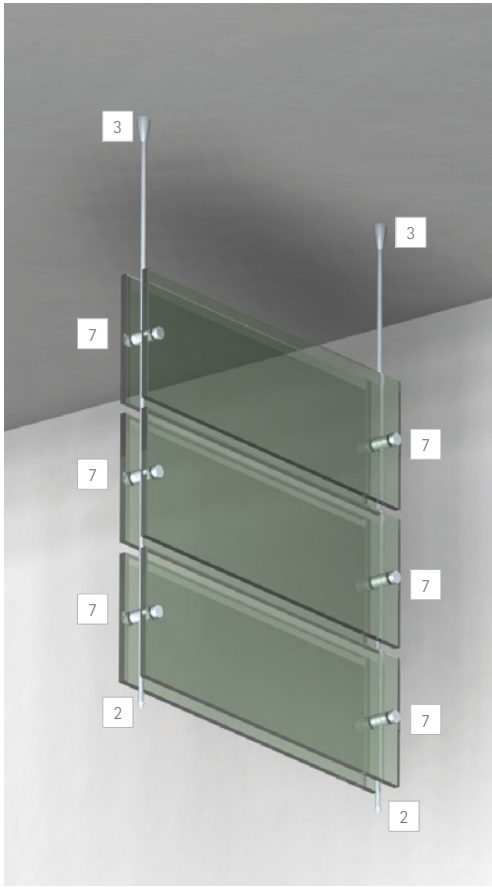
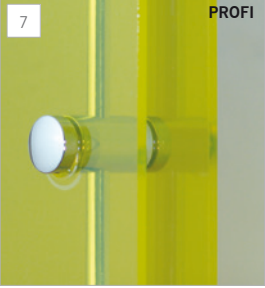
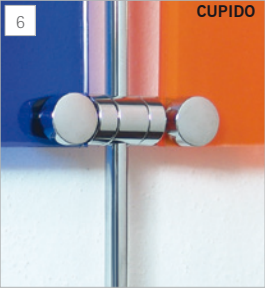
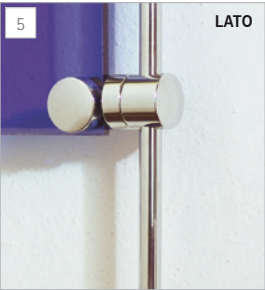

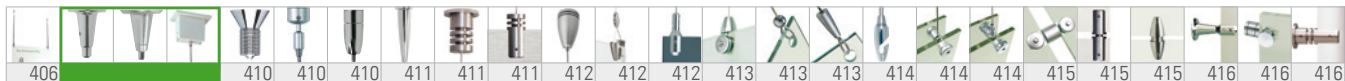

plus

MADE IN EU design by KD

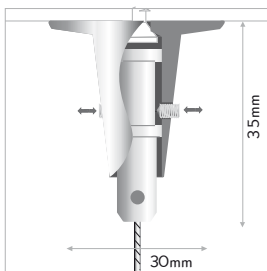

**IT** tirante per cavi con sistema a brugola. fissaggio a soffitto universale per cavi di acciaio o di nylon o per catenelle. montare il tirante a soffitto, inserire il cavo nel morsetto e fissarlo con le brugole. materiale: ottone cromato. spessore del cavo: max. Ø1,8mm.

**DE** seilhalter, schraubsystem. universelle deckenbefestigung für stahlseil, kette oder nyllonschnur. deckenhalter montieren, seil in die klemme schieben und mit madenschraube sichern. material: messing veredelt. seilstärke: max. Ø1,8mm.

**EN** cable support, screw system. universal ceiling fastener for cable, chain or nylon thread. mount the fastener, insert the cable into the clamp and fasten with allen screw. material: plated brass. cable thickness: max. Ø1,8mm.

combinations

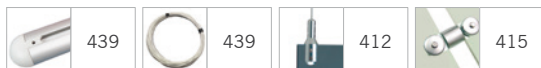

nero   schwarz   black	FP3040SZ*	20pcs	1box	pz/st/pc
oro   gold   gold	FP3040GD*	20pcs		
chromo   chrom   chrome	FP3040CM	20pcs		
argento   silber   silver	FP3040AR	20pcs		

\* fino ad esaurimento scorte | solange vorrat reicht | while stock last

plusmatic

MADE IN EU design by KD

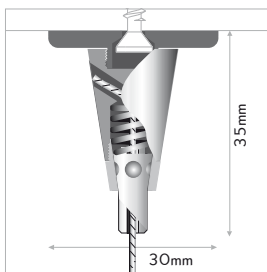

**IT** tirante per cavi con sistema autobloccante. fissaggio a soffitto per cavi di acciaio o di nylon. montare il tirante a soffitto e inserire il cavo nel morsetto. il meccanismo di autobloccaggio trattiene automaticamente il cavo. fissaggio: tirante per cavi, sistema autobloccante. mat: ottone color cromo lucido e argento satinato. distanza dal soffitto: 35mm. spessore cavo: max. Ø1,8mm.

**DE** seilhalter, maticsystem. universelle deckenbefestigung für stahlseil oder nyllonschnur. deckenhalter montieren, seil in die klemme schieben. die selbstschliessende mechanik blockiert das seil auf zug. befestigung: seilhalter, maticsystem. wandabstand: 35mm, stahlseil max. Ø1,8mm.

**EN** cable support, self-locking. universal ceiling fastener for steel cable or nylon thread. mount the fastener, insert the cable. the self-locking mechanism holds the cable by pull. mounting: cable support, self-closing. wall distance: 35mm. cable thickness: max. Ø1,8mm.

combinations

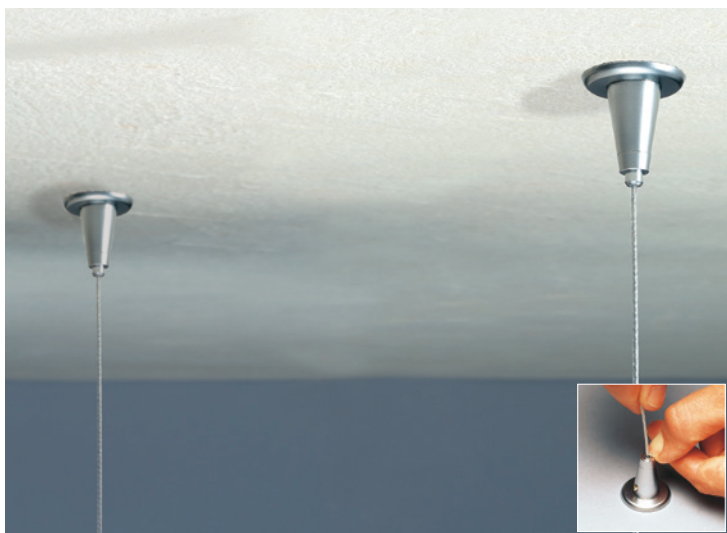
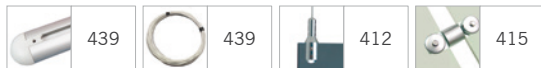

oro   gold   gold	FPM3530GD*	20pcs	1box	pz/st/pc
chromo   chrom   chrome	FPM3530CM*	20pcs		
argento   silber   silver	FPM3530AR	20pcs		

\* fino ad esaurimento scorte | solange vorrat reicht | while stock last

con

MADE IN EU design by KD

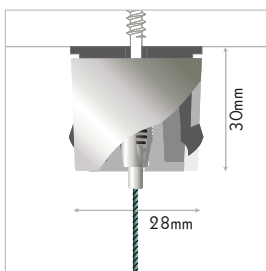

fissare il tirante a soffitto  
halter deckenmontieren  
mount the support to the ceiling

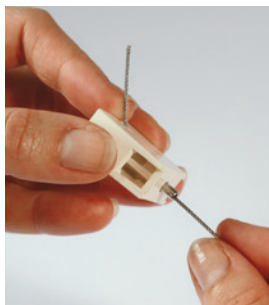

inserire il cavo nel sistema matic  
seil duch den matic-verschluss einziehen  
insert the cable through the self-lock system



agganciare il fermacavo  
seilhalter aufklipsen  
clip on the cable support



il fermacavo può essere rimosso in qualsiasi momento  
seilhalter kann einfach jederzeit wieder entfernt werden  
cable support can be removed easily anytime



**IT** fermacavo per montaggi a soffitto con sistema matic di chiusura in materiale plastico. fissare il tirante a soffitto, inserire il cavo, agganciare ed il gioco è fatto. Fissaggio: fermacavo con sistema matic; distanza dal soffitto: 28mm, spessore del cavo: max.  $\varnothing$ 1,8mm

**DE** seilhalter für deckenmontage mit matic schnellverschluss aus kunststoff. halter deckenmontieren, seil montieren, aufklipsen, fertig. befestigung: seilhalter maticsystem, abstand: 28mm, seilstärke max.  $\varnothing$ 1,8mm

**EN** synthetic cable support for ceiling with matic locksystem. mount the support to the ceiling, fix the cable, clip on the cable support. mounting: cable support, self-closing, wall distance: 28mm, cable thickness: max.  $\varnothing$ 1,8mm.

combinations



con

FCN2928

20pcs

1box

pz/st/pc

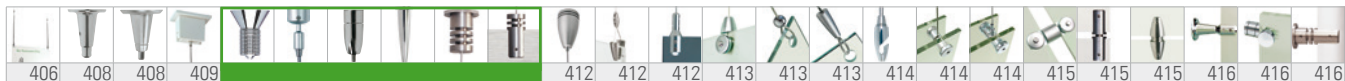

## fix

MADE IN EU design by KD

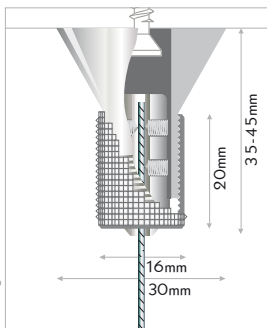

**IT** tirante per cavi, sistema in tensione a brugola. fissaggio a soffitto universale per cavi di acciaio, nylon o per catenelle. montare il tirante a soffitto, inserire il cavo nel morsetto e fissarlo con le brugole. regolare la tensione avvitando la parte zigrinata. materiale: ottone cromato. spessore del cavo: max. Ø1,8mm.

**DE** seilhalter, schraub-spannsystem. universelle befestigung für stahlseil, kette, oder nylon-schnur. halter montieren, seil mit madenschraube sichern, durch ver-schrauben der hülse stufenlos spannen. material: messing veredelt. seil: max. Ø1,8mm.

**EN** cable support, screw-tautsystem. universal fastener for steel cable, chain or nylon thread. mount the fastener, fix cable with allen screw, clamp stepless taut by screwing the hull. material: plated brass. cable thickness: max. Ø1,8mm.



combinations

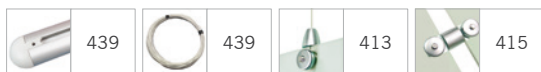

	oro   gold   gold	YF3045GD	10pcs	1box	pz/st/pc
	cromo   chrom   chrome	YF3045CM	10pcs		
	argento   silber   silver	YF3045AR	10pcs		

## plusmini

MADE IN EU design by KD

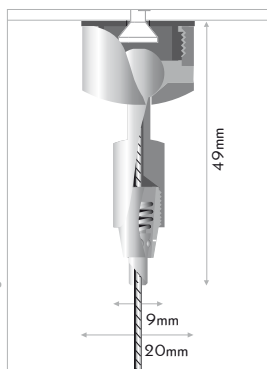

**IT** tirante snodabile per cavi, sistema autobloccante. fissaggio a soffitto universale per cavi di acciaio o nylon. montare il tirante a soffitto e inserire il cavo nel morsetto. il meccanismo di autobloccaggio trattiene automaticamente il cavo. materiale: ottone cromato. spessore cavo: max. Ø1,2mm.

**DE** seilhalter, matic-system, klappbar. universelle befestigung für stahlseil oder nyloonschnur. halter montieren, seil einschieben. selbstschliessende mechanik blockiert das seil auf zug. material: messing veredelt. seilstärke: max. Ø1,2mm.

**EN** foldable cable support, self-locking. universal ceiling fastener for steel cable or nylon thread. mount the fastener, insert the cable. the self-locking mechanism holds the cable by pull. material: plated brass. cable thickness: max Ø1,2mm.



	argento   silber   silver	YPM2070AR	10pcs	1box	pz/st/pc
--	---------------------------	-----------	-------	------	----------

## plusdesign

MADE IN EU design by KD

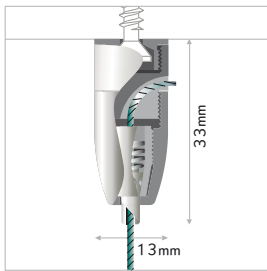

**IT** tirante per cavi con sistema autobloccante. fissaggio a soffitto per cavi di acciaio. montare il tirante a soffitto, inserire il cavo nel morsetto e regolare la tensione e la lunghezza del cavo grazie al forellino laterale. il meccanismo di autobloccaggio trattiene il cavo. materiale: ottone con cromatura. spessore del cavo: max. Ø1,2mm.

**DE** seilhalter, matic-system. universelle befestigung für stahlseil oder nylon-schnur. halter montieren, seil einschieben. die selbstschliessende mechanik blockiert das seil auf zug. material: messing oberflächenveredelt. seilstärke: max. Ø1,2mm.

**EN** cable support, self-locking. universal ceiling fastener for steel cable or nylon thread. mount the fastener, insert the cable. the self-locking mechanism holds the cable by pull. material: plated brass. cable thickness: max. Ø1,2mm.



combinations

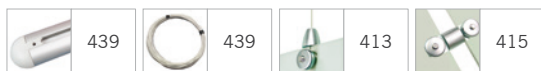

	argento   silber   silver	YPD1333AR	20pcs	1box	pz/st/pc
--	---------------------------	-----------	-------	------	----------



# loop

MADE IN EU design by KD

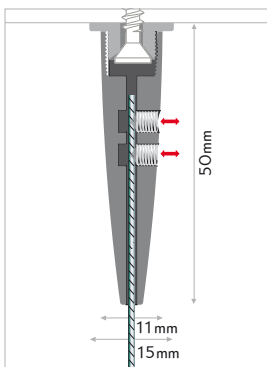

**IT** tirante per cavi con sistema a brugola. fissaggio a soffitto universale per cavi di acciaio o di nylon o per catenelle. montare il tirante a soffitto, inserire il cavo nel morsetto e fissarlo con le brugole. fissaggio: tirante per cavi, sistema a brugola. materiale: ottone cromato. spessore del cavo: max. Ø1,8mm.

**DE** seilhalter, schraubsystem. universelle deckenbefestigung für stahlseil, kette oder nylonseil. deckenhalter montieren, seil einschieben und mit madenschraube sichern. material: messing oberflächenveredelt. seilstärke: max. Ø1,8mm.

**EN** cable support, screw system. universal ceiling fastener for cable, chain or nylon thread. mount the fastener, insert the cable and fasten with allen screw. material: plated brass. cable thickness: max. Ø1,8mm.



combinations

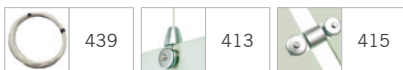

argento | silber | silver

**YLOOPAR**

20pcs

1 box

pz/st/pc

# steel plus

MADE IN EU design by KD

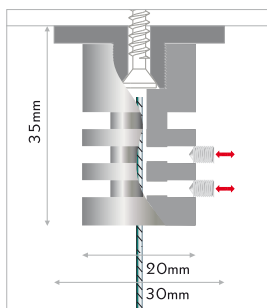

**IT** tirante in acciaio per cavi con sistema a brugola. fissaggio a soffitto universale, in acciaio inox, per cavi di acciaio o di nylon o per catenelle. montare il tirante a soffitto, inserire il cavo nel morsetto e fissarlo con le brugole. materiale: acciaio AISI303, testina con sfaccettature. spessore del cavo: max. Ø1,8mm.

**DE** edelstahl seilhalter, schraubsystem. universelle deckenbefestigung aus edelstahl für stahlseil, kette oder nylonseil. deckenhalter montieren, seil in die klemme schieben und mit madenschraube sichern. material: edelstahl AISI303, facettenschliff. seilstärke: max. Ø1,8mm.

**EN** stainless steel cable support, screw system. universal ceiling fastener for cable, chain or nylon thread. mount the fastener, insert the cable into the clamp and fasten with allen screw. material: stainless steel AISI303, facet finish. cable thickness: max. Ø1,8mm.

combinations

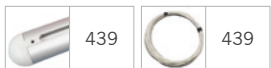

acciaio | stahl | steel

**FPS3035IX**

10pcs

1 box

pz/st/pc

# steel unvers

MADE IN EU design by KD

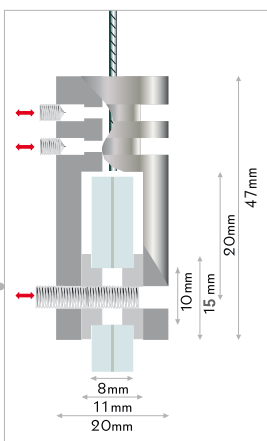

**IT** morsetto in acciaio per pannelli con cavi. morsetto per cavi di acciaio o di nylon o per catenelle. il fissaggio del pannello e del cavo avviene tramite le brugole. anellini di protezione inclusi. fissaggio: morsetto per pannelli, sistema a brugola. materiale: acciaio AISI303, testina con sfaccettature. spessore del pannello: max. 8mm o 11mm senza anellini. spessore del cavo: max. Ø1,8mm.

**DE** edelstahl paneelhalter für seil. halter für stahlseil, kette oder nylonseil. befestigung von paneel und seil mit madenschrauben. inklusive glasschutzringe. befestigung: paneelhalter für seil, schraubsystem. material: edelstahl AISI303, facettenschliff. plattenstärke: max. 8mm bzw. 11mm ohne ringe. seilstärke: max. Ø1,8mm.

**EN** stainless steel panel support for cable. panel support for cable, chain or nylon thread. fixing of panel and cable with allen screws. protecting rings included. mounting: panel support, screw system. material: stainless steel AISI303, facet finish. panel thickness: max 8mm resp. 11mm without rings. cable thickness: max. Ø1,8mm.



combinations

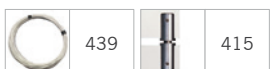

acciaio | stahl | steel

**FUS2047IX**

10pcs

1 box

pz/st/pc

soffitto e bandiera | decke und fahne | ceiling and flagsigns

fisso



## steel ceilingmatic

MADE IN EU design by KD

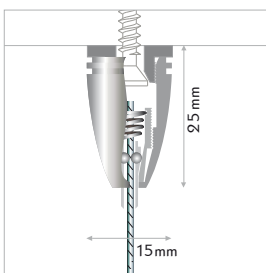

**IT** tirante in acciaio per cavi con sistema autobloccante. fissaggio a soffitto universale per cavi di acciaio o di nylon. montare il tirante a soffitto e inserire il cavo nel morsetto. il meccanismo di autobloccaggio trattiene automaticamente il cavo. materiale: acciaio AISI303. distanza dal soffitto: 25mm. spessore del cavo: max. Ø1,2mm.

**DE** seilhalter in edelstahl, matic-system. universelle deckenbefestigung für stahlseil oder nylonseil. deckenhalter montieren, seil in die klemme schieben. die selbstschliessende mechanik blockiert das seil auf zug. befestigung: seilhalter, matic-system, einfach, genau, sicher. material: edelstahl AISI303. wandabstand: 25mm. seilstärke: max. Ø1,2mm.

**EN** stainless steel cable support, self-locking. universal ceiling fastener for steel cable or nylon thread. mount the fastener, insert the cable. the self-locking mechanism holds the cable by pull. mounting: cable support, self-closing, easy, exact, safe. material: stainless steel AISI303. wall distance: 25mm. cable thickness: max. Ø1,2mm.



combinations

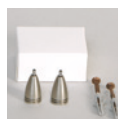
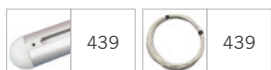

acciaio | stahl | steel

**FCM1525IX\***

10pcs

1box

pz/st/pc

\* fino ad esaurimento scorte | solange vorrat reicht | while stock last

## steel pinch

MADE IN EU design by KD

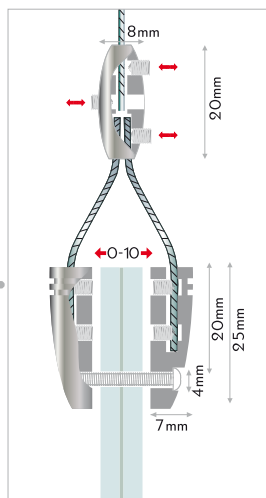

**IT** morsetto variabile in acciaio per pannelli con cavi. morsetto per cavi di acciaio o di nylon o per catenelle. il fissaggio del pannello e del cavo avviene tramite le brugole. fissaggio: morsetto per pannelli, variabile, per diversi spessori, sistema a brugola. materiale: acciaio AISI303. spessore del pannello: max. 10mm. grazie all'utilizzo di brugole più lunghe è possibile fissare anche spessori maggiori. spessore del cavo: max. Ø1,8mm.

**DE** variabler edelstahl paneelhalter für seil. halter für stahlseil, kette oder nylonseil. befestigung von paneel und seil mit madenschrauben. befestigung: paneelhalter für seil, variabel für diverse stärke, schraubensystem. material: edelstahl AISI303. plattenstärke: max.10mm, mehr mit längerer madenschraube. seilstärke: max. Ø1,8mm.

**EN** variable stainless steel panel support for cable. panel support for cable, chain or nylon thread. fixing of panel and cable with allen screws. mounting: panel support, variable fitting different thickness, screw system. material: stainless steel AISI303. panel thickness: max 10mm, more with longer allen screw. cable thickness: max. Ø1,8mm.



acciaio | stahl | steel

**FPI0725IX\***

10pcs

1box

pz/st/pc

\* fino ad esaurimento scorte | solange vorrat reicht | while stock last

## univers

MADE IN EU design by KD

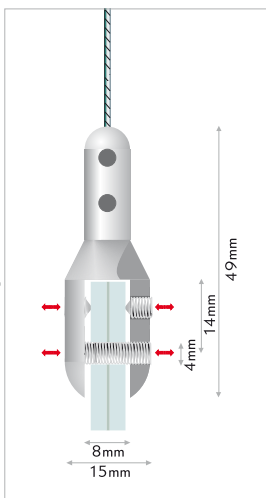

**IT** morsetto variabile in acciaio per pannelli con cavi. morsetto per cavi di acciaio o di nylon o per catenelle. il fissaggio del pannello e del cavo avviene tramite le brugole. materiale: ottone con cromatura. spessore del cavo: max. Ø1,8mm.

**DE** paneelhalter für seil. halter für stahlseil, kette oder nylonseil. befestigung von paneel und seil mit madenschrauben. material: veredeltes messing. seilstärke: max. Ø1,8mm.

**EN** panel support for cable. panel support for cable, chain or nylon thread. fixing of panel and cable with allen screws. material: plated brass. cable thickness: max. Ø1,8mm.



combinations

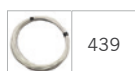

nero | schwarz | black

**FU1549SZ\***

20pcs

1box

pz/st/pc

oro | gold | gold

**FU1549GD\***

20pcs

cromo | chrom | chrome

**FU1549CM**

20pcs

argento | silber | silver

**FU1549AR**

20pcs

\* fino ad esaurimento scorte | solange vorrat reicht | while stock last

## univers design

MADE IN EU design by KD

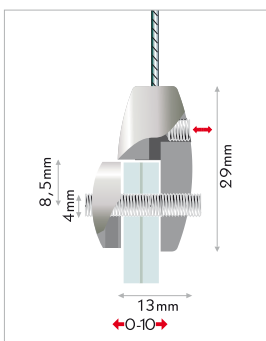

**IT** morsetto variabile per pannelli con cavi. morsetto per cavi di acciaio o di nylon o per catenelle. il fissaggio del pannello e del cavo avviene tramite le brugole. materiale: ottone con cromatura. spessore del cavo: max.  $\varnothing 1,8\text{mm}$ .

**DE** paneelhalter für seil, variabel. halter für stahlseil, kette oder nyllonschnur. befestigung von paneel und seil mit madenschrauben. material: veredeltes messing. seilstärke: max.  $\varnothing 1,8\text{mm}$ .

**EN** panel support for cable, variable. panel support for cable, chain or nylon thread. fixing of panel and cable with allen screws. material: silver- or chrome-plated brass. cable thickness: max.  $\varnothing 1,8\text{mm}$ .

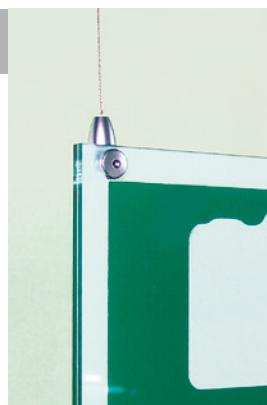

combinations



argento | silber | silver

FUD1329AR

20pcs

1box

pz/st/pc

## perla

MADE IN EU design by KD

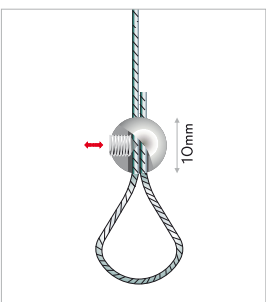
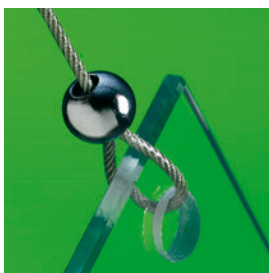

**IT** fermacavo. far passare il cavo di acciaio o di nylon all'interno del fermacavo e bloccarlo con la brugola. materiale: ottone cromato. spessore del cavo: max.  $\varnothing 1,8\text{mm}$ .

**DE** schlaufenklemme für seil. stahlseil oder nyllonschnur zur schlaufe durchschieben und mit madenschraube sichern. material: messing verchromt. seilstärke: max.  $\varnothing 1,8\text{mm}$ .

**EN** loop clamp for cable. slide through steel cable or nylon thread forming a loop and fast it with allen screw. material: chrome-plated brass. cable thickness: max.  $\varnothing 1,8\text{mm}$ .



combinations



cromo | chrom | chrome

FPE10CM

40pcs

1box

pz/st/pc

## lasso

MADE IN EU design by KD

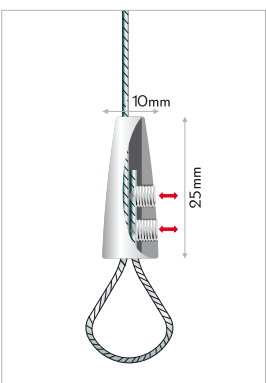

**IT** fermacavo. far passare il cavo di acciaio o di nylon all'interno del fermacavo e bloccarlo con la brugola. materiale: ottone cormato. spessore del cavo: max.  $\varnothing 1,8\text{mm}$ .

**DE** schlaufenklemme für seil. stahlseil oder nyllonschnur zur schlaufe durchschieben und mit zwei madenschrauben sichern. material: messing veredelt. seilstärke: max.  $\varnothing 1,8\text{mm}$ .

**EN** loop clamp for cable. slide through steel cable or nylon thread forming a loop and fast it with two allen screws. material: plated brass. cable thickness: max.  $\varnothing 1,8\text{mm}$ .



combinations



argento | silber | silver

FLA1025AR

40pcs

1box

pz/st/pc



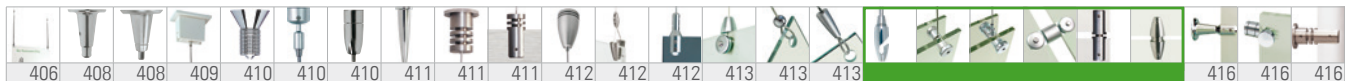

## hook

MADE IN EU design by KD

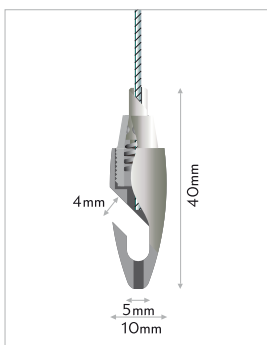

**IT** gancio per pannelli con sistema autobloccante. gancio multiuso per cavo di acciaio o di nylon. nella parte superiore si infila il cavo di acciaio, mentre nella parte inferiore si possono agganciare i pannelli. il fissaggio del cavo è semplice e veloce grazie al sistema autobloccante: inserire il cavo nel gancio, il meccanismo di autobloccaggio trattiene automaticamente il cavo. materiale: ottone cromato. spessore del cavo: max. Ø1,2mm.

**DE** anker für paneel und seil, matic-system. vielseitiger anker für stahlseil oder nylnonschnur. oben: zum einhängen an spannsenlen und anderen vertikalen führungen. unten: zur befestigung für paneele. seilbefestigung unkompliziert, schnell und sicher mit matic-system: seil in den anker schieben, die selbstschliessende mechanik blockiert das seil auf zug. material: chrom veredeltes messing. seilstärke: max. Ø1,2mm.

**EN** anchor support for panel and cable, self-locking. versatile anchor support for cable or nylon thread. on top: hanging to tether or other vertical guiding. downwards: attaching panels. thanks to the self-locking system cable mounting is easy, quick and safe: insert the cable into the anchor, the self-locking mechanism holds the cable by pull. material: brass chrome-plated. cable thickness: max. Ø1,2mm.



combinations



chromo | chrom | chrome

1 box

pz/st/pc

FHM1040CM

20 pcs

## univers mini

MADE IN EU design by KD

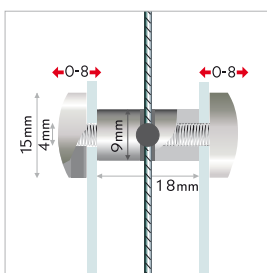

**IT** connettore bifacciale per pannelli con sistema a brugola. per la connessione laterale di due pannelli su cavi di acciaio. il fissaggio avviene tramite una brugola. fissaggio: connettore bifacciale, a due lati, per pannelli su cavi di acciaio, con sistema a brugola. materiale: ottone cromato, spessore del cavo: max. Ø1,2mm.

**DE** paneelverbinder für seil, doppelseitig, variabel, schraubsystem. für die verbindung und befestigung von doppel-paneelen am stahlseil. befestigung mit madenschrauben. material: veredeltes messing. seil: max. Ø1,2mm.

**EN** panel connector for cable, double-sided, variable, screw-system. connect and suspend double panels. fastening with allen screws. material: brass plated. cable: max. Ø1,2mm.



combinations

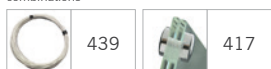

chromo | chrom | chrome

1 box

pz/st/pc

FUB1518CM\*

20 pcs

argento | silber | silver

FUB1518AR

20 pcs

\* fino ad esaurimento scorte | solange vorrat reicht | while stock last

## univers matic

MADE IN EU design by KD

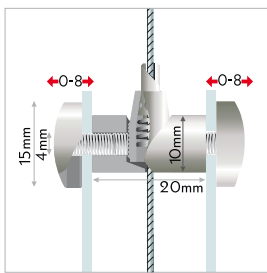

**IT** connettore bifacciale per pannelli, sistema autobloccante. per la connessione laterale di 2 pannelli su cavi di acciaio tramite brugola. il meccanismo di autobloccaggio trattiene automaticamente il cavo. materiale: ottone cromato. spessore del cavo: max. Ø1,2mm.

**DE** paneelverbinder für seil, doppelseitig, variabel, maticsystem. für die verbindung und befestigung von doppel-paneelen am stahlseil. paneelbefestigung mit madenschrauben, seil mit maticsystem. material: messing veredelt. seil: max. Ø1,2mm

**EN** panel connector for cable, doubleside, variable, matic system. connect and suspend double panels. fasten panels with allen screws, cable with self-locking system. material: plated brass. cable: max. Ø1,2mm.



combinations

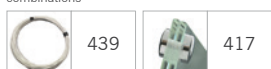

chromo | chrom | chrome

1 box

pz/st/pc

FMB1520CM\*

20 pcs

argento | silber | silver

FMB1520AR

20 pcs

\* fino ad esaurimento scorte | solange vorrat reicht | while stock last

## union design

MADE IN EU design by KD

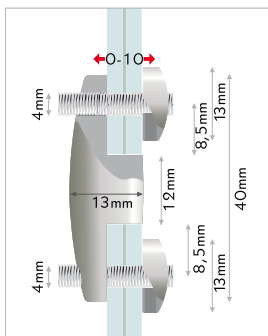

combinations

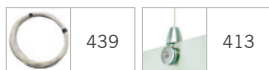

**IT** connettore bifacciale per pannelli, sistema autobloccante. morsetto in ottone lavorato per la connessione verticale di due pannelli. connettore flessibile per pannelli con diversi spessori. il fissaggio avviene tramite le brugole. materiale: ottone cromato. spessore del cavo: max. Ø1,8mm.

**DE** variabler paneelverbinder. halter aus veredeltem messing für die verbindung von paneelen untereinander. flexibel einstellbar für diverse plattenstärken. befestigung mit madenschrauben. material: veredeltes messing. seil: max. Ø1,8mm

**EN** variable panel connector. plated brass support to connect panels with each other. can be adjusted to the panel thickness. fixing of panel with allen screws. material: plated brass. cable: max. Ø1,8mm.

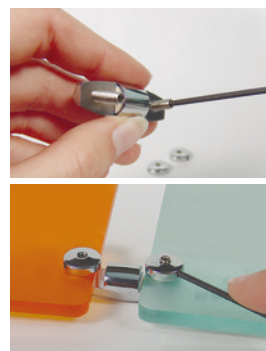

cromo | chrom | chrome

1box

pz/st/pc

FOD1340CM\*

20pcs

\* fino ad esaurimento scorte | solange vorrat reicht | while stock last

## steel union

MADE IN EU design by KD

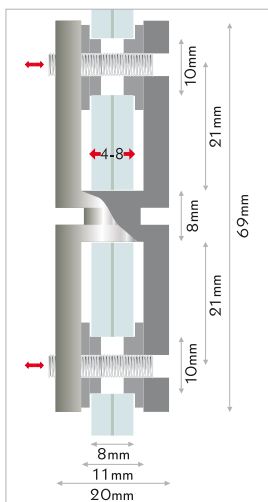

combinations

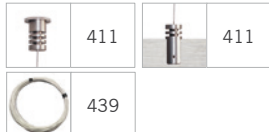

**IT** connettore in acciaio per pannelli. morsetto in acciaio inox per la connessione verticale di pannelli. il fissaggio avviene tramite le brugole. anellini di protezione inclusi. fissaggio: connettore di pannelli. materiale: acciaio inox AISI303 lucidato.

**DE** paneelverbinder aus edelstahl. halter aus edelstahl für die verbindung von paneelen untereinander. befestigung mit madenschrauben, inklusive glasschutzringe. befestigung: paneelverbinder. material: edelstahl AISI303 glanzpoliert.

**EN** stainless steel panel connector. stainless steel support to connect one panel under the other. fixing of panel with allen screws, protecting rings included. mounting: panel connector. material: stainless steel AISI303, glossy finish.



acciaio | stahl | steel

1box

pz/st/pc

FNS2069IX\*

10pcs

\* fino ad esaurimento scorte | solange vorrat reicht | while stock last

## steel unite

MADE IN EU design by KD

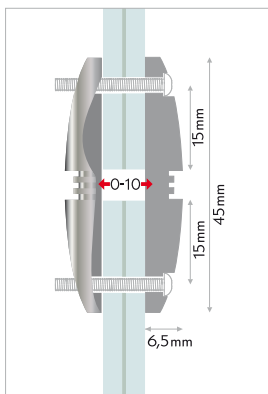

combinations



**IT** connettore variabile in acciaio per pannelli. morsetto in acciaio inox per la connessione verticale di pannelli. il fissaggio avviene tramite le brugole. fissaggio: connettore variabile per pannelli con diversi spessori. materiale: acciaio inox AISI303.

**DE** variabler paneelverbinder aus edelstahl. halter aus edelstahl für die verbindung von paneelen untereinander. befestigung mit madenschrauben. befestigung: paneelverbinder, variabel für diverse stärken. material: edelstahl AISI303.

**EN** variable stainless steel panel connector. stainless steel support to connect one panel under the other. fixing of panel with allen screws. mounting: panel connector, variable fitting different thickness. material: stainless steel AISI303.



acciaio | stahl | steel

1box

pz/st/pc

FUT0745IX\*

10pcs

\* fino ad esaurimento scorte | solange vorrat reicht | while stock last

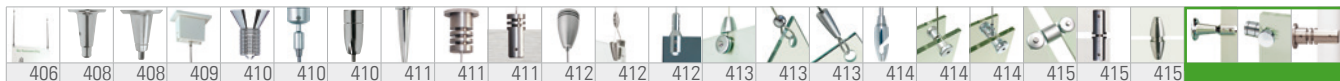

## uniplus

MADE IN EU design by KD

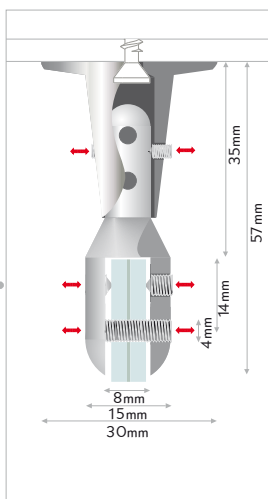

**IT** morsetto a bandiera per parete o soffitto. per montaggi di pannelli a bandiera o direttamente a soffitto. il fissaggio del pannello avviene tramite le brugole. fissaggio: morsetto a bandiera con sistema a brugola. materiale: ottone con cromatura.

**DE** paneelhalter für wand/decke. für direkte wand- oder deckenmontage von auslegern und fahnschildern. befestigung des paneels mit madenschrauben. befestigung: paneelhalter für wand/decke, schraubsystem. material: veredeltes messing.

**EN** panel support for wall/ceiling. for wall- or ceilingmounted flagsigns. fixing of the panel with allen screws. mounting: panel support for wall/ceiling, screw system. material: plated brass.



combinations



	cromo   chrom   chrome	1 box	pz/st/pc
	FUP3060CM	20pcs	
	argento   silber   silver		
	FUP3060AR	20pcs	

## uniplus style

MADE IN EU design by KD

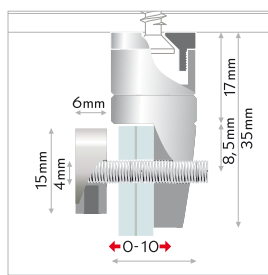

**IT** morsetto variabile a bandiera per parete o soffitto. per montaggi di pannelli a bandiera o direttamente a soffitto. morsetto flessibile per pannelli con diversi spessori. il fissaggio del pannello avviene tramite le brugole. fissaggio: morsetto variabile a bandiera con sistema a brugola. materiale: ottone cromato.

**DE** variabler paneelhalter für wand/decke. für direkte wand- oder deckenmontage von auslegern und fahnschildern. flexibel für diverse plattenstärken. befestigung des paneels mit madenschraube. befestigung: paneelhalter für wand/decke, variabel, schraubsystem. material: veredeltes messing.

**EN** variable panel support for wall/ceiling. for wall- or ceilingmounted flagsigns. adjustable to panel thickness. fixing of the panel with allen screws. mounting: panel support for wall/ceiling, variable, screw system. material: plated brass.



combinations



	cromo   chrom   chrome	1 box	pz/st/pc
	FSUP1535CM	20pcs	
	argento   silber   silver		
	FSUP1535AR	20pcs	

## steel uniplus

MADE IN EU design by KD

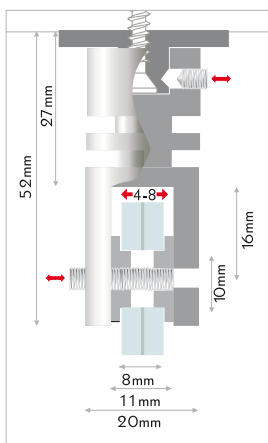

**IT** morsetto a bandiera in acciaio per parete o soffitto. per montaggi di pannelli a bandiera o direttamente a soffitto. il fissaggio del pannello avviene tramite le brugole. anellini di protezione inclusi. fissaggio: morsetto a bandiera con sistema a brugola. materiale: acciaio inox AISI303.

**DE** edelstahl paneelhalter für wand/decke. für direkte wand- oder deckenmontage von auslegern und fahnschildern. befestigung des paneels mit madenschrauben. inklusive glasschutzringe. befestigung: paneelhalter für wand/decke, schraubsystem. material: edelstahl AISI303.

**EN** panel support for wall/ceiling. for wall- or ceilingmounted flagsigns. fixing of the panel with allen screws. protecting rings included. mounting: panel support for wall/ceiling, screw system.



combinations



	acciaio   stahl   steel	1 box	pz/st/pc
	FUPS3052IX	10pcs	

\* fino ad esaurimento scorte | solange vorrat reicht | while stock last

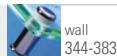

wall  
344-383

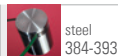

steel  
384-393

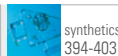

synthetics  
394-403



ceiling-  
flagsigns  
404-417



special  
418-427

## steel wall pin

MADE IN EU design by KD

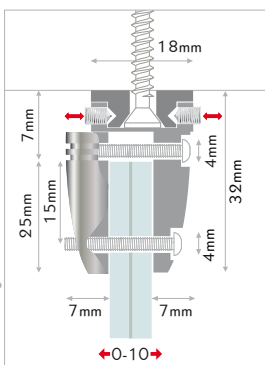

**IT** morsetto variabile a bandiera in acciaio per parete o soffitto. per montaggi di pannelli a bandiera o direttamente a soffitto. il fissaggio del pannello avviene tramite le brugole. fissaggio: morsetto variabile a bandiera con sistema a brugola. materiale: acciaio inox AISI303.

**DE** variabler edelstahl paneelhalter für wand/decke. für direkte wand- oder deckenmontage von auslegern und fahnschildern. befestigung des paneels mit madenschrauben. befestigung: paneelhalter für wand/decke, variabel für diverse stärken, schraubensystem. material: edelstahl AISI303.

**EN** variable panel support for wall/ceiling. for wall- or ceilingmounted flagsigns. fixing of the panel with allen screws. mounting: panel support for wall/ceiling, screw system, variable fitting different thickness. material: stainless steel AISI303.



combinations



acciaio | stahl | steel

1box

pz/st/pc

FWP0732IX\*

10pcs

\* fino ad esaurimento scorte | solange vorrat reicht | while stock last

## punto

MADE IN EU design by KD

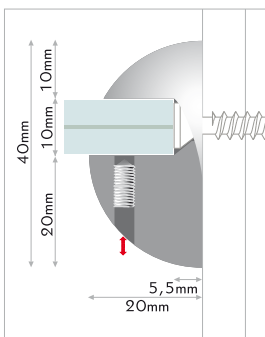

**IT** supporto per pannelli e ripiani per parete/soffitto o da banco. grazie a punto possono venir fissate targhe e pannelli ma anche ripiani e piccoli scaffali in qualsiasi posto e posizione. materiale: ottone con cromatura.

**DE** paneel- und ablagenhalter für wand/decke/boden. befestigen sie mit fisso punto schilder und paneele, aber auch ablagen in jeder position und in jedem winkel. punto lässt sich wand-, decken- oder bodenmontieren mit vielfältigen anwendungsmöglichkeiten. material: veredeltes messing.

**EN** panel support for wall/ceiling/floor. mount with punto signs and panels but also shelves in any position and angle. punto can be mounted on wall, ceiling or floor. use punto for a lot of purposes material: plated brass.

combinations



cromo | chrom | chrome

1box

pz/st/pc

FPT4020CM

10pcs

argento | silber | silver

FPT4020AR

10pcs

## button

MADE IN EU design by KD

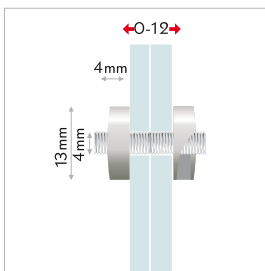

**IT** connettore variabile per pannelli a sandwich. volete tener uniti pannelli a sandwich appesi a soffitto o a bandiera? grazie a button, i vostri pannelli vengono tenuti uniti in modo elegante e sicuro. materiale: ottone con cromatura, foro del pannello: Ø>4mm.

**DE** variabler sandwich paneelverbinder. sandwich-systeme deckenabgehängt oder als ausleger-schild sicher verbinden? button der verschluss aus veredeltem messing hält ihre paneele zusammen. material: veredeltes messing.lochbohrung: Ø>4mm.

**EN** variable sandwich panel connector. connecting sandwich-panels ceiling-suspended or as flagsign safely? button the plated brass fastener connects your panels. material: plated brass. panel hole: Ø>4mm.



combinations



oro | gold | gold

FBT1304GD\*

40pcs

cromo | chrom | chrome

FBT1304CM

40pcs

argento | silber | silver

FBT1304AR

40pcs

\* fino ad esaurimento scorte | solange vorrat reicht | while stock last

soffitto e bandiera | decke und fahne | ceiling and flagsigns

fisso

# FISSO SPEZIAL

## fisso speciali

**IT** tutto quello che serve per applicazioni speciali: sostegni per targhette da tavolo, segnaposto e porta messaggi, come anche ripiani, connettori e sistemi di fissaggio in acciaio, in ottone lavorato o in materiale plastico.

## fisso spezial



**DE** alles für die spezielle anwendung: halter für tisch- und preisschilder sowie ablagen, verbinder und stecksysteme, in stahl, veredeltem messing oder kunststoff

## fisso special

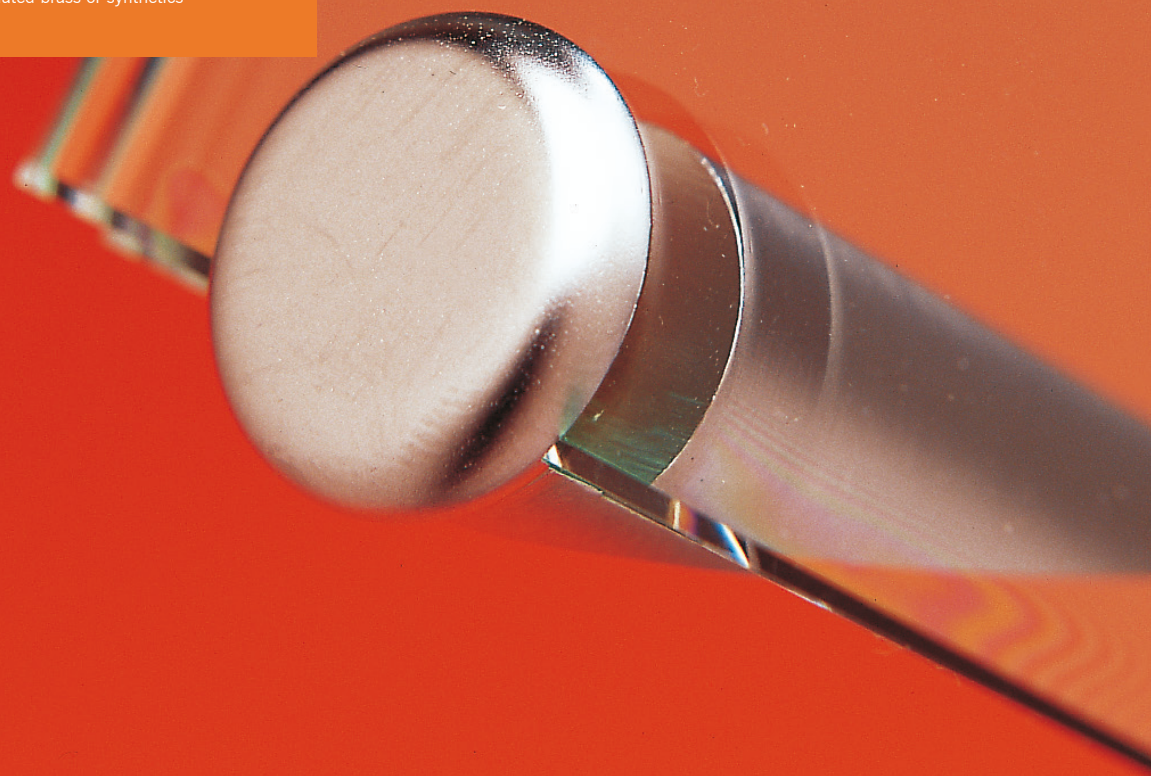
**EN** everything for the very special application: holder for countersigns or price tags and shelves, connectors and module systems, made of stainless steel, plated brass or synthetics



							
desk	table	punto	aven	croco cube	set antenna/ arco	antenna components	digiplug
420	420	421	421	422	422	423	424

		
connector	ix bond	artrail
425	426	427

# desk

MADE IN EU design by KD

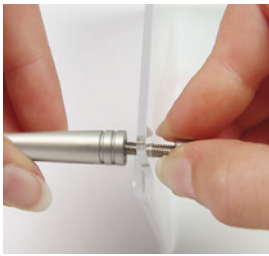
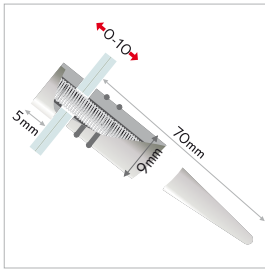
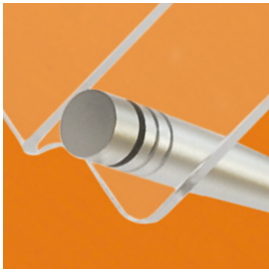





**IT** supporto da tavolo variabile con sistema a brugola. desk, elegante e variabile, è la soluzione ideale per le vostre informazioni da tavolo e da banco. inserire il pannello nella brugola e fissarlo con la testina anteriore. grazie alla posizione del foro da praticare, si può scegliere e definire l'inclinazione del pannello: più in alto è il foro, maggiore sarà l'inclinazione del pannello. per pannelli singoli come anche per sistemi a sandwich. materiale: ottone cromato o alluminio anodizzato. foro del pannello: Ø4mm.

**DE** thekeninfo, variables steck-schraubsystem. desk extravagant und variabel, ihre lösung für counterpräsentation. gewindesttift durch das paneel stecken, mit body und kopf verschrauben. durch positionierung der lochbohrung bestimmen sie die neigung des aufstellers: je höher die bohrung, desto mehr neigung erhält das paneel. für einzelpaneel wie sandwich-systeme gleichermaßen geeignet. material: messing veredelt oder eloxiertes aluminium. lochbohrung: Ø4mm.

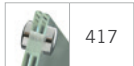
**EN** sign support for counter, variable plug-screwsystem. desk is your choice when you look for a fancy counter sign support. put the allen screw through the panel, screw on body and head. with the position of the hole you adjust the inclination of the sign: the higher the hole the more the panel leans back. adapted for single signs as well as for sandwich-systems. material: plated brass or anodized aluminium. hole: Ø4mm

combinations



	cromo   chrom   chrome	1 box	pz/st/pc
	FDK0975CM*	10 pcs	
	argento   silber   silver		
	FDK0975AL	10 pcs	

\* fino ad esaurimento scorte | solange vorrat reicht | while stock last

# table

MADE IN EU design by KD

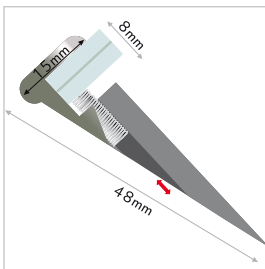
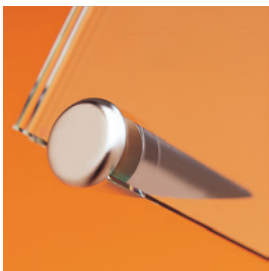







**IT** informazioni da tavolo con stile. soluzione design pratica ed elegante per espositori da tavolo e da banco. appoggio stabile per segnaposto, cartellini di informazione, e cornici in vetro, legno, acrilico o metallo. il fissaggio avviene tramite la brugola nascosta sotto la base del supporto. materiale: ottone con cromatura.

**DE** thekeninfo mit stil. praktische und elegante designlösung für tisch- und thekenaufsteller. stabiler stand für schilder, tischkarten oder fotorahmen. befestigung erfolgt mit der auf der unterseite verdeckt liegenden madenschraube. material: messing veredelt.

**EN** stylish sign support for counter. convenient and elegant support for table and counter. signs, frames, or name cards stand firm with table support. suitable for all materials like glass, wood, acrylic or metal. the panels are fixed with the allen screw on the rear side. material: plated brass.

combinations



	cromo   chrom   chrome	1 box	pz/st/pc
	FT1548CM	20 pcs	
	argento   silber   silver		
	FT1548AR	20 pcs	
	nero   schwarz   black		
	FT1548SZ*	20 pcs	

\* fino ad esaurimento scorte | solange vorrat reicht | while stock last

# punto

MADE IN EU design by KD

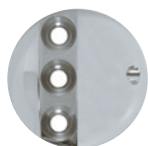
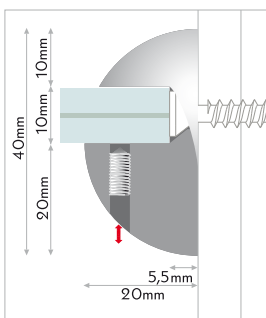
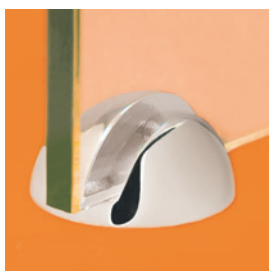

**IT** supporto per pannelli e ripiani per parete/soffitto o da banco. grazie a punto possono venir fissate targhe e pannelli ma anche ripiani e piccoli scaffali in qualsiasi posto e posizione. punto infatti si può utilizzare a parete, a soffitto o da banco, offrendo svariate possibilità di applicazione: anche come base per segnaposto da tavolo. materiale: ottone con cromatura.

**DE** paneel- und ablagenhalter für wand/decke/boden. befestigen sie mit fisco punto schilder und paneele, aber auch ablagen in jeder position und in jedem winkel. punto lässt sich wand-, decken- oder bodenmontieren mit vielfältigen anwendungsmöglichkeiten: u.a. als counter-schild. material: veredeltes messing.

**EN** panel support for wall/ceiling/floor. mount with punto signs and panels but also shelves in any position and angle. punto can be mounted on wall, ceiling or floor. use punto for a lot of purposes: small shelves or wall racks, ceiling and wall mounted for partition or for your name plate on desk and counter. material: plated brass.

combinations

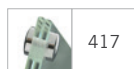

417



cromo | chrom | chrome

1 box

pz/st/pc

FPT4020CM

10pcs

argento | silber | silver

FPT4020AR

10pcs

# aven

MADE IN EU design by KD



**IT** ventose trasparenti ø40mm con pinza croco, filetto interno M4 o vite da M4 e dado esagonale.

**DE** transparente saugnapfe ø40mm mit crocklemme, mit M4 gewinde oder M4 gewindestift und mutter.

**EN** transparent suction cups ø40mm, with croco clip, M4 thread or M4 threaded pin and hex nut.



1 AVENCR

10pcs

1 box

pz/st/pc

2 AVENFI

10pcs

3 AVEN4010

10pcs



## croco cube





MADE IN EU design by KD



**IT** croco cube. accattivanti cubetti con morsetti in 4 colori. materiale: morsetto nichelato, cubetto in materiale plastico. altezza: 120mm. cubetto: ogni lato 25mm. confezione: 16pz.

**DE** croco cube. peppige clips in vier farben. material: clip vernickelt, würfel kunststoff. höhe: 120mm. würfel: 25mm kantenlänge. packung: 16st.

**EN** croco cube. cool clips in four different colours. material: clip nickel-plated, cube synthetics. height: 120mm. cube: 25mm edge length. box: 16pcs.

		1box	pz/st/pc
	verde   grün   green CRCUBVE	16pcs	
	bianco   weiss   white CRCUBWE	16pcs	
	blu   blau   blue CRCUBBL	16pcs	
	rosso   rot   red CRCUBRS	16pcs	

## set antenna



MADE IN EU design by KD



**IT** antenna regolabile in altezza grazie ai bracci telescopici. in combinazione con la base piana per l'esposizione di prezzi o informazioni, in vetrina, come segnaposto o porta-messaggi. ideali anche per la presentazione di oggetti piccoli e leggeri. materiale: ottone cromato, morsetto nichelato.

**DE** stufenlos verstellbare teleskopantenne mit extra starker krokodilklemme. zusammen mit antenna basis flach. für die preisauszeichnung, zur schaufenstergestaltung, als tischaufsteller oder infohalter. auch für die präsentation kleiner, leichter objekte geeignet. material: messing verchromt, clip vernickelt.

**EN** antenna infinitely adjustable for height with very strong alligator crimp. in combination with antenna flat base for price tags, decoration of the shop window, as table display or information support. even suitable for the presentation of small and lightweight objects. material: chrome-plated brass, crimp nickel-plated.

			pz/st/pc
	+		
	FAC350BFL	90-350mm, set01	
	FAC830BFL	165-830mm, set01	
	FAC1200BFL	235-1200mm, set01	

## set antenna & arco



MADE IN EU design by KD



**IT** antenna regolabile in altezza grazie ai bracci telescopici. in combinazione con la base piana per l'esposizione di prezzi o informazioni, in vetrina, come segnaposto o porta-messaggi. ideali anche per la presentazione di oggetti piccoli e leggeri. connettore 180° con bussola per antenna incluso, semplicemente avvitare. materiale: ottone cromato, morsetto nichelato.

**DE** stufenlos verstellbare teleskopantenne mit extra starker krokodilklemme. zusammen mit antenna basis flach. für die preisauszeichnung, zur schaufenstergestaltung, als tischaufsteller oder infohalter. auch für die präsentation kleiner, leichter objekte geeignet. inkl. 180° verbindler mit gewindehülse für antennen, einfach anschrauben. material: messing verchromt, clip vernickelt.

**EN** antenna infinitely adjustable for height with very strong alligator crimp. in combination with antenna flat base for price tags, decoration of the shop window, as table display or information support. even suitable for the presentation of small and lightweight objects. incl. connector for 180° turn of antenna, simply screw on. material: chrome-plated brass, crimp nickel-plated.

			pz/st/pc
	+		+
			
	FACA830BFL	165-830mm, set01	
	FACA1200BFL	235-1200mm, set01	

## antenna

MADE IN EU design by KD

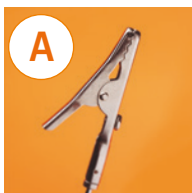

**IT** antenna con morsetto a cocodrillo. regolabili in altezza grazie ai bracci telescopici, disponibili in 4 formati, tutti dotati di un robusto morsetto a cocodrillo. in combinazione con le basi per antenne per l'esposizione di prezzi o informazioni, in vetrina, come segnaposto o porta-messaggi. ideali anche per la presentazione di oggetti piccoli e leggeri. materiali: ottone cromato, morsetto nichelato. confezione: 5pz.

**DE** antenna clip. stufenlos höhenverstellbare teleskop-antenne in vier grössen mit extra starker krokodilklamme. zusammen mit antenna basis für die preisauszeichnung, zur schaufenstergestaltung, als tischaufsteller oder infohalter. auch für die präsentation kleiner, leichter objekte geeignet. material: messing verchromt, clip vernickelt. packung: 5st.

**EN** antenna clip. infinitely adjustable for height in four sizes with very strong alligator crimp. in combination with antenna base for price tags, decoration of the shop window, as table display or information support. even suitable for the presentation of small and lightweight objects. material: chrome-plated brass, crimp nickel-plated. box: 5pcs.

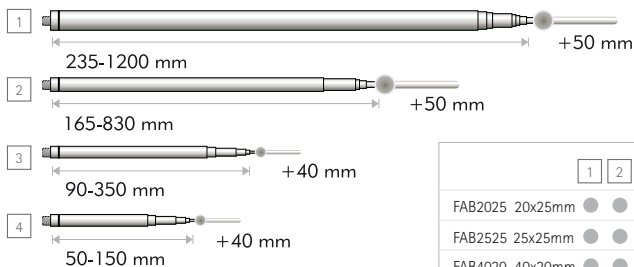

	1	2	3	4
FAB2025	20x25mm	●	●	
FAB2525	25x25mm	●	●	
FAB4020	40x20mm	●	●	●
FAB5010	50x10mm	●	●	●

	1	2	3	4	1 box	pz/st/pc
1	FA50150	50-150+40mm, 5pcs				
2	FA90350	90-350+40mm, 5pcs				
3	FA165830	165-830+50mm, 5pcs				
4	FA2351200	235-1200+50mm, 5pcs				

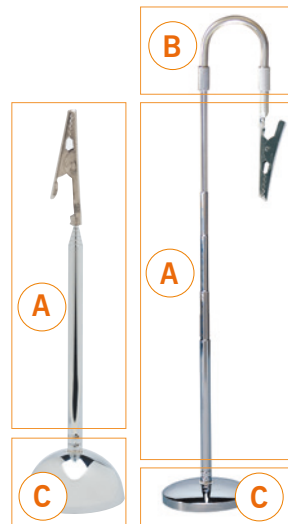

## arco

MADE IN EU design by KD



**IT** arco per antenna. connettore 180° con bussola per antenna. semplicemente avvitare. materiale: acciaio inox, bussola ottone nichelato, con filettatura per il sostegno delle antenne. confezione: 5pz.

**DE** antennenbogen. 180° verbinder mit gewindehülse für antennen. einfach anschrauben. material: edelstahl, hülse messing vernickelt, mit gewinde für antenna clip. packung: 5st.

**EN** antenna arc. connector for 180° turn of antenna. simply screw on. material: stainless steel, huls brass nickel-plated, with thread for antenna clip. box: 5pcs.

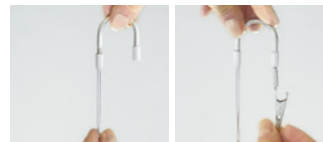

	5	1 box	pz/st/pc
5	FARC180*	5pcs	

\* fino ad esaurimento scorte | solange vorrat reicht | while stock last

## antenna base

MADE IN EU design by KD

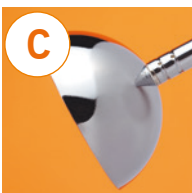

**IT** basi per antenne: a semicerchio, piatta, conica o a punta. in combinazione con le antenne. materiale: ottone cromato con filettatura per il sostegno delle antenne. confezione: 5pz.

**DE** antenna basis: halbrund, flach, konisch oder als steckfuss. material: messing verchromt, mit gewinde für antenna clip. packung: 5st.

**EN** antenna base: hemisphere, flat, conic or as a stick. material: brass chrome-plated, with thread for antenna clip. box: 5pcs.

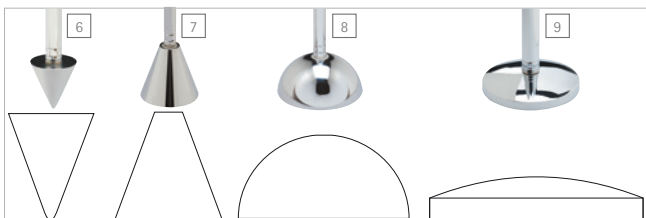

	6	7	8	9	1 box	pz/st/pc
6	FAB2025*	20x25mm, 5pcs				
7	FAB2525*	25x25mm, 5pcs				
8	FAB4020	40x20mm, 5pcs				
9	FAB5010	50x10mm, 5pcs				

\* fino ad esaurimento scorte | solange vorrat reicht | while stock last

# digiplug

MADE IN CHINA quality control by KD

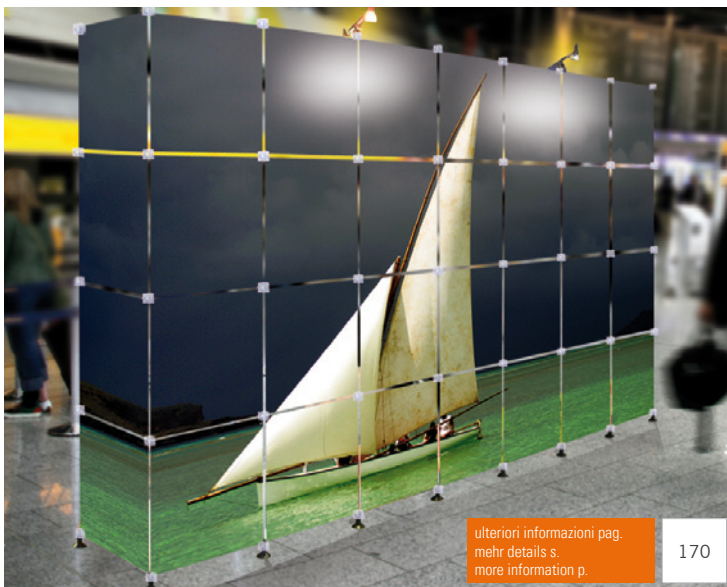
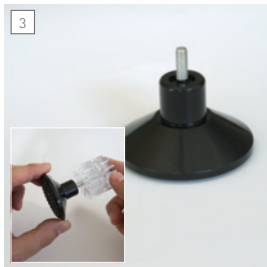
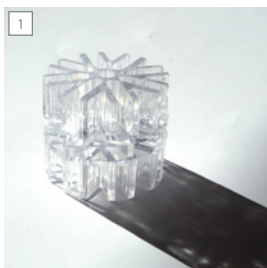

ulteriori informazioni pag.  
mehr details s.  
more information p.

170

**IT** leggero, facile da usare, veloce da installare: ecco digiplug, il connettore ad 8 vie per pannelli con spessore di 4 mm. digiplug è particolarmente consigliato con pannelli leggeri, di piccole dimensioni e quadrati, perchè il connettore si monta sugli angoli, non in mezzo. digiplug da un lato è filettato, per consentirne l'utilizzo con tutta una serie di accessori. vi offriamo digiplug come set completo fornito in un a pratica valigetta per il trasporto o a singoli componenti.

**DE** schnell leicht und einfach: das ist digiplug 8-wege verbinder für 4mm starke paneele. besonders empfiehlt sich digiplug mit kleinformatigen, quadratischen leichtstoffplatten, da digiplug an den ecken, nicht mittig, eingesetzt wird. jeder digiplug hat an einer seite ein gewinde für die befestigung von zubehör. wir bieten ihnen digiplug als komplettset im praktischen transportkoffer oder als einzelkomponente an.

**EN** quick, light and easy: this is digiplug, the 8-way connector for 4mm panels. especially recommended is digiplug with small sized, squared lightweight panels as the connector is used at the corners, not in the middle. every digiplug comes with a thread on one side for mounting the accessories. we offer digiplug as a complete set with handy transport case or as single components.

## information

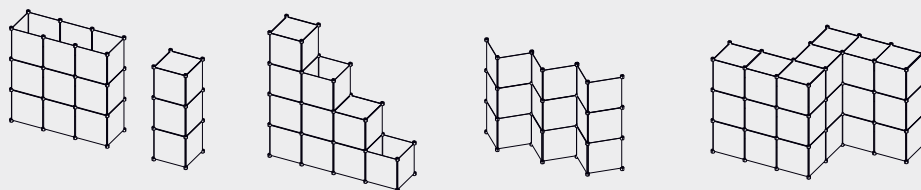

particolarmente indicato per pannelli leggeri flessibili e non troppo rigidi o per cartone di 5 mm di spessore, ma che si possano ridurre a 4 mm durante l'inserimento in digiplug.

besonders geeignet für flexible leichtstoffplatten oder karton mit 5mm, die sich auf 4mm bei ein-schub reduzieren.

especially recommended for flexible lightweight panels or cardboards with 5mm that reduce to 4mm when inserted

			pz/st/pc
1	DPLU8TR	digiplug full, 1 pc	
2	DPLU5TR	digiplug half, 1 pc	
3	DPLUREG	digiplug regular, 1 pc	
4	DPLUAVEN	digiplug suction cup, 1 pc	
5	DPLULMP	digiplug lamp, 1 pc	

# connector

MADE IN TAIWAN quality control by KD

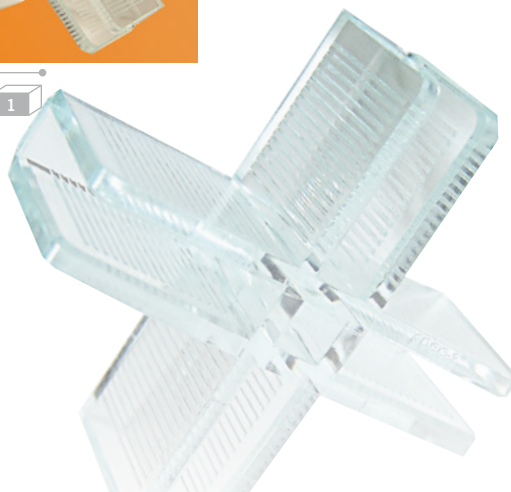

ulteriori informazioni pag.  
mehr details s.  
more information p.

172



**IT** sistema modulare per vetrine ad incastro. realizzate la vostra personalissima vetrina con pannelli da 5mm ed i fissaggi angolari connector in policarbonato color vetro. a seconda della forma e delle dimensioni della vostra applicazione, ordinate i singoli pezzi che vi servono. gli esempi qui riproposti vi aiutano nella scelta del fissaggio giusto. ideale per negozi, showroom, musei, vetrine e anche per l'arredamento di casa.

**DE** schlagfeste eckverbinder aus glasgrünem polycarbonat für cuben nach dem baukasten-system. gestalten sie ihre persönliche vetrine mit connector eckhaltern und 5mm-paneeeln. die beispieleskizzen helfen Ihnen bei der richtigen auswahl der entsprechenden eckverbinder. eine tolle sache für shop, showroom, museum, schaufenster und homebereich.

**EN** shock-resistant panel-connector made of glassgreen polycarbonate for modular cube systems. create your personal vitrine with 5mm-panels and connectors. the drawings with examples help you choosing the right parts. it's a peach for shop, showroom, museum, shop window and home as well.

## information

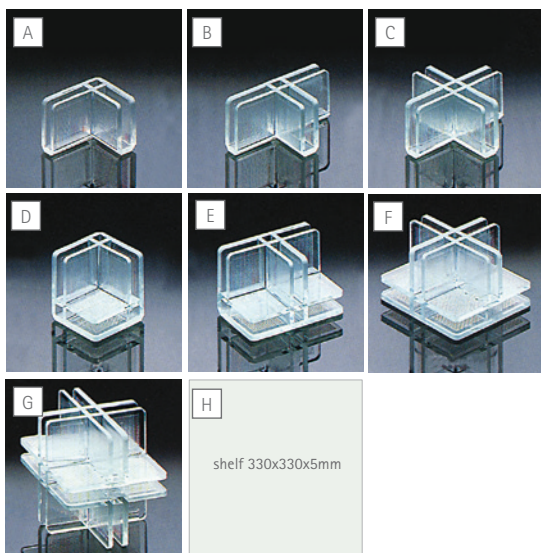
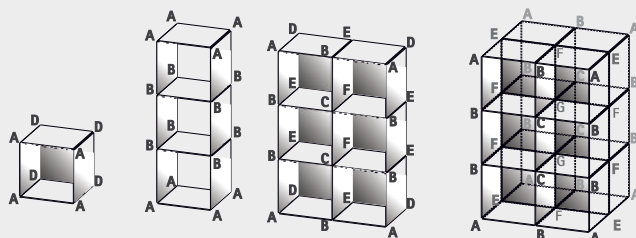

shelf 330x330x5mm

pz/st/pc

A	FCONA	1pc
B	FCONB	1pc
C	FCONC	1pc
D	FCOND	1pc
E	FCONE	1pc
F	FCONF	1pc
G	FCONG	1pc
H	FCON330PL	shelf, transparent acrylic, 330x330x5mm 1pc

# ix bond

MADE IN EU design by KD

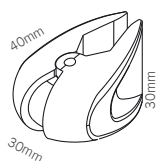
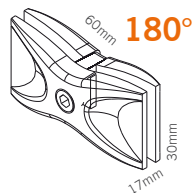
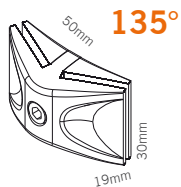
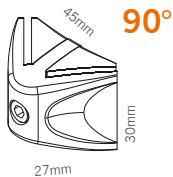
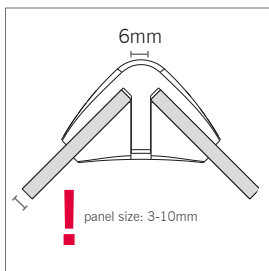

6



**IT** ixbond può connettere pannelli da 3 a 10mm con sicurezza e senza il rischio di torsioni. discreto e funzionale una volta uniti, i pannelli risulteranno a soli 6mm di distanza. la vite di chiusura é facilmente raggiungibile dal lato esterno e dal lato interno garantendo cosí la migliore comoditá di esercizio - pratico, specialmente per strutture 3D o vicino alle pareti. ergonomici e decorativi „snodi“ per montare in convenienza. cacciaviti a parte

**DE** ixbond verbindet panel von 3-10mm stufenlos sicher und verwindungsstabil. die sichtfuge bleibt dabei immer dezent mit 6mm. die schraube kann beidseitig (innen wie aussen) eingesetzt werden - praktisch, wenn sie räumliche konstruktionen umsetzen oder nahe an wänden bauen. ergonomische und ästhetische griffmulden erleichtern die montage. gewünschte anzahl inbus-schlüssel bitte extra bestellen.

**EN** ixbond connects 3-10mm panels infinitely and free of torsion. the face joint remains at a discrete 6mm gap. the screw can be mounted from both sides. convenient if you create structures in 3-D or close to walls. ergonomic and decorative recessed grips make mounting easy. order the required keys separately.

## information

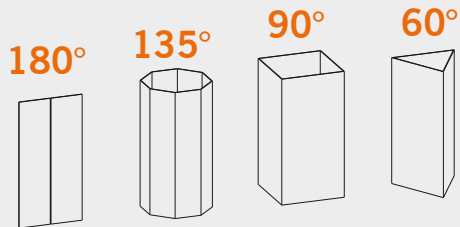

			pz/st/pc
1	IX2B60AR	60° connector, 1pc	
2	IX2B90AR	90° connector, 1pc	
3	IX2B120AR	135° connector, 1pc	
4	IX2B180AR	180° connector, 1pc	
5	IX2BSWAR	sandwich connector, 1pc	
6	SOKEY4	t-handle hex key, 1pc	

# artrail

MADE IN EU design by KD

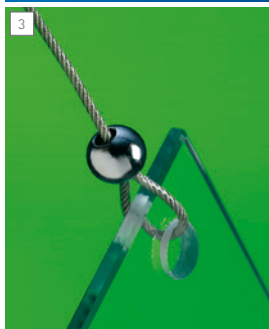
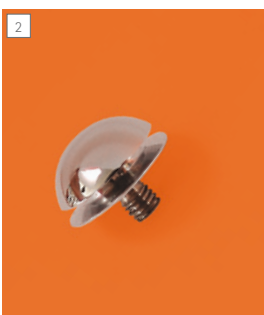
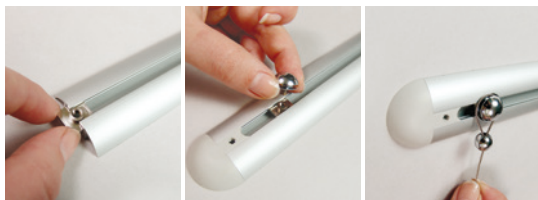

**IT** l'arte della presentazione. fly rail in combinazione con point, perla e hook, è ideale non solo per gallerie e per musei, ma può diventare un ottimo strumento anche per arredatori d'interni, decoratori e per allestitori di fiere e negozi. veloce da montare, facile e comodo da cambiare e posizionare. utilizzate più HOOK per presentare oggetti uno sotto l'altro. un consiglio: grazie a fly lot è possibile creare un elegante sistema in tensione. ordine: scegliete liberamente i componenti singoli in base alle esigenze del vostro allestimento.

**DE** die kunst der präsentation. fly rail kombiniert mit point, perla und hook, ideal nicht nur für galerien und museen, sondern auch für inneneinrichter, dekorateure, messe- und ladenbauer. schnell montiert, austausch wie positionierung jederzeit einfach und bequem. mit HOOK oben und unten: mehrere objekte übereinander kein problem. unser tip: mit fly lot ein elegantes spannsystem. bestellung: ganz flexibel wählen Sie je nach größe Ihrer anwendung die menge der einzelnen komponenten.

**EN** the art of presentation. fly rail in combination with point, perla and hook, ideal not only for galleries and museums, but also for decorators, shop fitters and booth builders. quickly mounted, exchange and positioning is quick and easy anytime. put hook on top and below: one object upon the other is no problem. our special. the straight tip: use FLY LOT and create an elegant suspended system. order: choose freely according to your application the quantity of the single components.

	<b>ARTRAIL</b>	alluminio   aluminium   aluminium			pz/st/pc
	<b>YRAIL20402000</b>		2000mm		
	<b>POINT</b>	cromo   chrom   chrome		1box	pz/st/pc
	<b>FPO1512CM</b>		40pcs		
	<b>PERLA</b>	cromo   chrom   chrome			
	<b>FPE10CM</b>		40pcs		
	<b>HOOK</b>	cromo   chrom   chrome			
	<b>FHM1040CM</b>		40pcs		
	<b>AFIL</b>	inox   stahl   steel		1box	1m
	<b>AFIL05</b>		Ø1,7mm, 5m		
	<b>AFIL25</b>		Ø1,7mm, 25m		
	<b>ABOB500</b>		Ø1,7mm, 500m		
	<b>AFIL</b>	inox   edelstahl   stainless steel			
	<b>AFILIX05</b>		Ø1,2mm, 5m		
	<b>AFILIX25</b>		Ø1,2mm, 25m		
	<b>AFILIX500</b>		Ø1,2mm, 500m		

combinations

