

## sistemi espositivi

**IT** soluzioni intelligenti e di stile per i professionisti della stampa digitale: porta banner, profili per banner, sistemi di presentazione, fissaggi, portabandiere, pannelli illuminati e una serie completa di espositori multimediali.

## displays & werbeträger









**DE** clevere lösungen mit für den digitaldruckprofi: banner- und leuchtdisplays, klemmprofile, spannrahmen, präsentations-systeme, spezial-befestigungen, fahnenmasten sowie eine reihe audiovisueller media-displays.

## digital print displays

**EN** clever and stylish applications for the digital printing pro: banner and presentation displays, profiles, frames, light panels, fasteners, flagpoles and a special series of media displays.



					
zip media	velo media	wingoo media   pirouet pad	pad man   pad woman	ipoint media	tv bond   tv rack   tv wall
116-117	118-119	120-121	122-123	124-125	126-127

							
postfix	bannerblock wallsupport	bannerboy   structure   pole	bannerblock	posterblock	backframe	monoframe	framframe wall
128-129	130-131	132-135	136	137	138-139	140-141	142-143

							
framframe floor   framframe multi	framframe silentart	framframe LED	lumo   lumo clipper	lumo twist	frame twist	wallup soistes	tex wall
144-145	146-147	148-149	150-151	152-153	154-155	156-157	158

							
print soistes	eLgrande   eleg	roll   x-image	ima2go bow   ima2go straight	ima2go tower   standbyU	pirouet vetrina   pirouet counter	digiplug	connector
159	160-161	162-163	164-165	166-167	168-169	170-171	172-173

							
ix bond	digipresso	mypresso	pylo   pylo poster	ipoint   pylo outdoor	outer   panelpod	signwalk   passboard	maxiboard   clip mobil
174-175	176-177	178-179	180-181	182-183	184-185	186-187	188-189

					
signcode eXtern	flag fix   big fix	monsterframe	angelframe	leoframe	tripole   giantpole   pirata
190-191	192-193	194-197	198-199	200-201	202-203



# zip media

 MADE IN EU design by KD

**IT** le immagini dicono più di 1000 parole: con zip media siete ben equipaggiati, multimediali e con una grande mobilità. al posto della tasca portacataloghi superiore abbiamo inserito nell'espositore un pannello di alluminio ed uno schermo lcd da 8". che siate in fiera, sul punto vendita, nello showroom o ad un evento, la presentazione audiovisiva vi assicurerà l'attenzione di tutti i presenti. zipmedia è anche personalizzabile, grazie alla tasca pixquick montata sul pannello frontale.

**DE** bilder sagen mehr als 1000 worte: mobil und multimedial sind sie mit zip media bestens gerüstet. statt der obersten prospekttasche haben wir ein silber eloxiertes aluminiumpaneel mit einem 8" lcd bildschirm eingebaut. ob auf mesen, am pos, im showroom oder bei events: audiovisuelle präsentation ist ange-sagt. passend zum anlass ist mit der pixquick tasche am frontpaneel der zipmedia im nu personalisiert.

**EN** images say more than 1000 words: with zip media your are mobile and multi-functionally equipped as well. instead of the top tray we have placed a silver anodized aluminium panel with a built-in 8" lcd screen. at fairs, at the pos, in your showroom or at events: you will certainly attract the attention with your audio-visual presentation. thanks to the pixquick frame on the front panel you can customize your zipmedia anytime in the blink of an eye.

1  
zip media



LCD display	LCD display	8" TFT LCD
	resolution	800x600 RGB
	active area	159mmx119mm (W x H)
	aspect ratio	4:3
picture playback	format	JPEG, BMP, GIF, PNG, TIFF
	max. resolution	800x600
	automatic slideshow	yes
video playback	supported video formats	mpeg1, mpeg2, mpeg4-asp, m-jpg, dvix, xvid, avi
music playback	audio formats	mp3, wma, aac, ogg
storage	USB sticks	up to 4GB
	SD/MMC card	up to 4GB (no SDHC cards)
	MS pro card	up to 4GB

[video configuration details](#) 478

zip media



1 ZMR8150AA

zip media, 1pc



personalizzazione semplice e veloce: stampare la grafica ed inserirla nel pixquick  
 personalisierung einfach und schnell: grafik ausdrucken, einlegen, fertig!  
 quick and easy customizing: print your graphics, insert in pixquick, ready!

### information

zip media: schermo lcd 8" digital media frame, pannello alluminio anodizzato, 3 tasche porta depliant A4 in policarbonato antiurto, 1 tasca A4 pixquick, base mdf verniciata argento

zip media: lcd 8" digital media frame, paneel silber eloxiertes aluminium, 3 prospektaschen DIN A4 aus schlagfestem polycarbonat, 1 postertasche A4

zip media: lcd 8" digital media frame, silver anodized aluminium panel, 3 brochure pockets for DIN A4 format made of shock-resistant polycarbonate, 1 poster pocket A4 pixquick base silver coated mdf. pixquick, basis silber lackiertes mdf

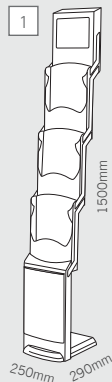

8"  
screen  
4:3

digi



# velo media

 MADE IN EU design by KD

**IT** rendete multimediali le vostre presentazioni: il classico velo si trasforma in velomedia. sotto lo schermo di 8" trovate lo spazio per esporre depliant in formato A4. tutti gli accessori della serie velo si possono utilizzare, dandovi così la possibilità di creare valore aggiunto grazie alle personalizzazioni.

**DE** werden sie multimedial in ihrer präsentation: der klassische velo zip wird zum velo media. unter dem 8" bildschirm hat velo media ein fach für printmedien in A4. das zubehör der velo serie passt auch zum velomedia und bietet ihnen mehrwert durch zusätzliche, personalisierbare werbeflächen.

**EN** make your presentation multimedia-based: the classic velo zip becomes velo media. below the 8" screen velo media has a brochure tray for A4 printed material. all the accessories of the velo series also fits to your velomedia giving you more value with additional customizable ad space.

1  
velo media



LCD display	LCD display	8" TFT LCD
	resolution	800x600 RGB
	active area	159mmx119mm (W x H)
	aspect ratio	4:3
picture playback	format	JPEG, BMP, GIF, PNG, TIFF
	max. resolution	800x600
	automatic slideshow	yes
video playback	supported video formats	mpeg1, mpeg2, mpeg4-asp, m-jpg, dvix, xvid, avi
music playback	audio formats	mp3, wma, aac, ogg
storage	USB sticks	up to 4GB
	SD/MMC card	up to 4GB (no SDHC cards)
	MS pro card	up to 4GB

[video configuration details](#) 478

## velo media



1	VELOMR8AA	velo media, 1pc	
2	BBVELO	velo bannerblock set, 2pcs	
3	VELOA4	velo poster pocket A4, 1pc	
4	VELODIV02	velo divider for 2 A6, 2 pcs	



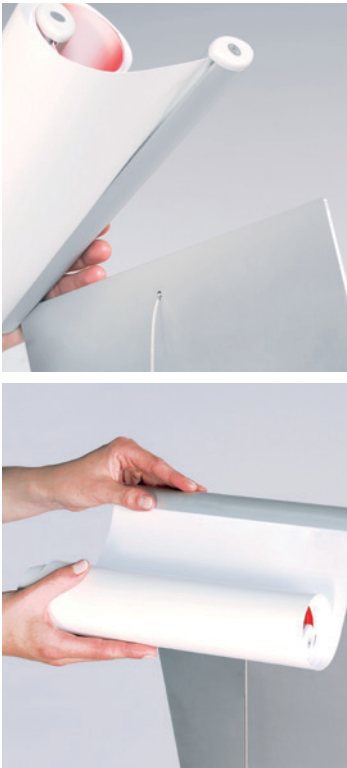

banner not included  
 1 + 2  
 price for this combination



memory card not included



8"  
screen

digi

**information**

velo media: schermo lcd 8" digital picture frame, pannello alluminio anodizzato, base mdf verniciata in color argento, 1set VELOATO1 per 1 A4 incluso

velo media: lcd 8" digitaler bilderrahmen, paneel silber eloxiertes aluminium, basis silber lackiertes mdf, 1 set VELOATO1 für 1 A4 fach inklusive.

velo media: lcd 8" digital picture frame, silver anodized aluminium panel, base silver coated mdf, 1 set VELOATO1 for 1 A4 incl.

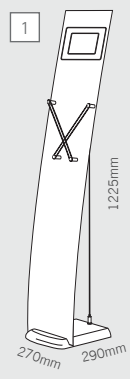

accessori velo: portainformazioni in A4 verticale; velo divider per 2 deplianti formato A6L; 2 profili bannerblock per una personalizzazione posteriore, grazie ad una stampa digitale, facili da appoggiare sull'espositore velomedia.

velo zubehör: A4 postertasche, velo divider für 2 A6 prospekte, 2 bannerblock klemmprofile für personalisierung der rückseite mit druck, einfach zum einhängen.

velo accessories: A4 poster pocket, velo divider for 2 A6 brochures, 2 bannerblock extrusions for customizing rear side with prints, easily attachable



8" screen

1 wingoo media



memory card not included



### information

schermo digitale lcd da 8", acrilico satinato, distanziatori in alluminio anodizzato color argento, elastici in silicone opaco

8" digitaler bilderrahmen, einseitig satiniertes acrylglas, silber eloxierte aluminium halter, opake silikonringe

8" digital picture frame, one side satin acrylic, silver anodised aluminium supports, opaque silicone rings

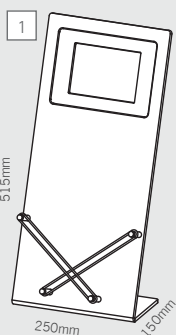

# wingoo media

MADE IN EU design by KD



clever: wingoo media si presenta in A4 verticale o A5 orizzontale.

clever: wingoo media präsentiert A4 vertikal und A5 horizontal

smart: wingoo media displays prints in A4 vertical or A5 horizontal.

**IT** piccolo ma efficace: è wingoo media, il nostro espositore da banco multimediale. grazie al suo schermo lcd da 8" wingoo media presenta le vostre foto o immagini con una musica di sottofondo, oppure i vostri filmati, insieme ai vostri prospetti o depliant in formato A4 verticale o A5 orizzontale. il suo aspetto gradevole e la sua eleganza discreta, dati dall'acrilico satinato, dai distanziatori in alluminio anodizzato color argento e dagli elastici in silicone opaco, lo rendono ideale e perfetto per ogni ambiente.

**DE** klein mit starker wirkung: der wingoo media unser multimedialer theken-präsentier. wingoo media mit 8" lcd bildschirm präsentiert ihre bilder mit hintergrundmusik oder kleine filme sowie gedruckte info in A4 vertikal oder A5 horizontal. das einseitig satinierte acrylglas mit den filigranen silber eloxierten alu-haltern und opaken silikonringen passt mit seiner dezenten eleganz perfekt in jedes ambiente.

**EN** small but with strong impact: the wingoo media our multimedia counter display. wingoo media with his 8" lcd screen displays your pictures with background music or short films as well as printed information in A4 vertical or A5 horizontal. the one side satin acrylic with the delicate silver anodised aluminium supports and the opaque silicone rings bring an elegant touch into every ambience.

LCD display	LCD display	8" TFT LCD
	resolution	800x600 RGB
	active area	159mmx119mm (W x H)
	aspect ratio	4:3
picture playback	format	JPEG, BMP, GIF, PNG, TIFF
	max. resolution	800x600
	automatic slideshow	yes
video playback	supported video formats	mpeg1, mpeg2, mpeg4-asp, m-jpg, divx, xvid, avi
music playback	audio formats	mp3, wma, aac, ogg
storage	USB sticks	up to 4GB
	SD/MMC card	up to 4GB (no SDHC cards)
	MS pro card	up to 4GB

video configuration details

478

## wingoo media

1 WGOR8MED

wingoo media, 1pc





1  
pirouet pad

print and ipad not included



# pirouet pad

MADE IN EU design by KD

**IT** pirouet pad counter è un punto di attrazione interattivo per tutte le vostre presentazioni! il design brevettato permette una facile e rapida costruzione della struttura. l'ipad, inserito sotto il piano opaco, renderà la vostra presentazione interattiva, multimediale e in ogni caso di successo! pirouet pad counter viene fornito con 6 pannelli personalizzabili, per un totale di circa 1,5 m<sup>2</sup> di superficie, da utilizzare come spazio per il vostro messaggio pubblicitario. il sistema è adatto per la prima e la seconda generazione di ipad. l'ipad non è compreso nella fornitura.

**DE** interaktive präsentation mit dem pirouet pad counter - ein attraktiver anziehungspunkt für jede präsentation! das patentierte design ermöglicht einen bequemen und schnellen aufbau durch einfaches hochziehen der struktur. im opaken tabletop wird das ipad eingebaut. damit wird ihre präsentation interaktiv, multimedial und in jedem fall ein voller erfolg. der pirouet pad counter wird mit 6 personalisierbaren paneelen geliefert. so erhalten sie 1,5m<sup>2</sup> zusätzliche fläche für ihre werbebotschaft. das system ist geeignet für die erste und zweite ipad generation. das ipad ist nicht im lieferumfang enthalten.

**EN** interactive presentation with pirouet pad counter - attracts attention for sure! the system sets up simply by turning the frame upwards thanks to its patented design. in the semi-transparent table top you can build in your ipad for a stunning interactive multimedia presentation. the counter comes with 6 customizable panels. offering a 1,5m<sup>2</sup> of additional space for your communication message. the system is suitable for first and second generation of ipads. ipad non included.



## information

struttura composta da 6 pannelli e tavolino in acrilico satinato

struktur mit 6 paneelen, top aus satiniertem acryl

structure incl. 6 panels, table top made of frosted acrylic

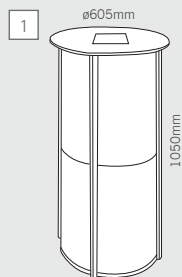

## pirouet pad

1	DPIRIP1000TR	pirouet pad, 1pc
2	DPIRBAG	bag pirouet, 1pc



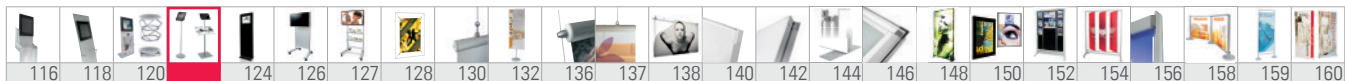

# pad man

MADE IN EU design by KD

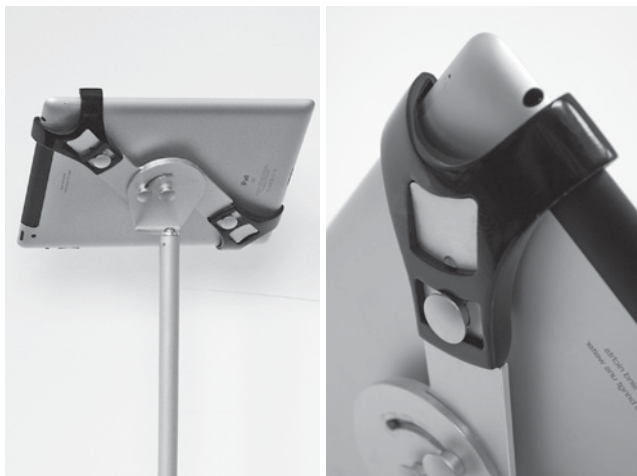

**IT** il nostro pad man sostiene il vostro ipad su una struttura telescopica in alluminio anodizzato color argento. pad man si monta in un batter d'occhio ed attira decisamente l'attenzione in tutte le presentazioni interattive. una base doppia assicura massima stabilità alla struttura. il sostegno studiato ad hoc vi permette l'utilizzo dell'ipad sia in orizzontale che in verticale, che si può ruotare di 90° direttamente sulla struttura e senza problemi. ipad non è compreso nella confezione.

**DE** unser pad man hält ihren ipad auf einer teleskop struktur aus silber eloxiertem aluminium. schnell aufgebaut ist der pad man ein attraktiver hingucker für jede interaktive präsentation. eine doppelte basis sorgt für ausreichend stabilität. die intelligente halterung erlaubt ihnen die horizontale wie vertikale verwendung. ohne probleme lässt sich der ipad um 90° drehen. das ipad ist im lieferumfang nicht enthalten.

**EN** our pad man holds your ipad on a telescopic structure made of silver anodized aluminium. quickly set up, the pad man is an attractive eye-catcher for any interactive presentation. a double base gives the necessary stability. the intelligent support allows to use your ipad horizontally or vertically. in no time at all the ipad can be turned 90°. the ipad is not included.

## information

alluminio anodizzato color argento, abs di colore nero, base in metallo laccata in color argento.

silber eloxiertes aluminium, schwarzes abs, silber lackierte metallbasis

silver anodized aluminium, black abs, silver coated metal base

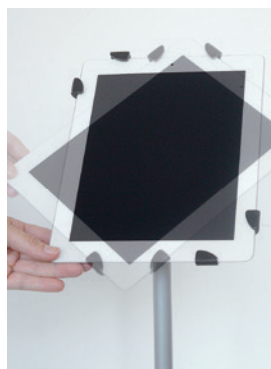
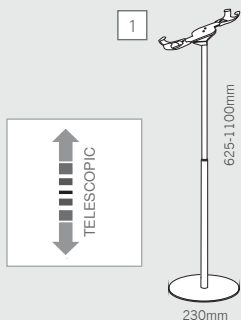

rotazione di 90°: semplice e veloce grazie alla vite integrata nel sostegno per ipad.

schnell um 90° grad gedreht: ganz einfach dank integrierter schraube in der halterung

90° switch easy and quick thanks to the integrated screw in the support

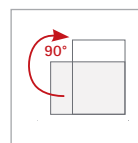

padman

1 PMN2301100AL

pad man, 1pc



# pad woman

MADE IN EU design by KD

**IT** pad woman è un display da terra autoportante per presentazioni interattive tramite ipad. l'ipad sarà al sicuro sulla stabile base in ABS stampata ad iniezione. sarà possibile aggiungere ripiani in acrilico satinato e ulteriori accessori della linea soistes. l'ipad può essere ruotato verticalmente o orizzontalmente in qualsiasi momento. i materiali resistenti e di alta qualità sono impreziositi da un design elegante e ricercato.

**DE** pad woman ist ein optimales bodendisplay für die multifunktionale präsentation mit ipad. auf der stabilen basis aus kunststoff-spritzguss steht der pad walley überall sicher. optional können sie prospektablagen aus mattem acrylglas anbringen. weiteres zubehör bietet unsere soistes linie. der ipad kann jederzeit ganz einfach von horizontal auf vertikal gedreht werden. alle materialien sind hochwertig und robust, dabei elegant und von edlem design.

**EN** pad woman is a perfect floor display for the multi-function presentation with an ipad. on its stable base made of die-cast abs the ipad walley is a robust stand. as an option, you can attach brochure trays made of satin acrylic. you will find more accessories with our soistes products. the ipad can be switched easily anytime between landscape and portrait positions. all materials are first-grade and robust yet elegant and of noble design.

rotazione di 90°: semplice e veloce grazie alla vite integrata nel sostegno per ipad.

*schnell um 90° grad gedreht: ganz einfach dank integrierter schraube in der halterung*

**90° switch easy and quick thanks to the integrated screw in the support**

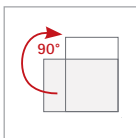

*ripiano per 2 depliant in A4 verticale, acrilico satinato, inclinabile orizzontalmente e posizionabile liberamente su tutta la lunghezza del profilo.*

*ablage für 2 A4 aus satiniertem acrylglas, horiz. neigbar und stufenlos höhenverstellbar bars made of silver anodized aluminium*

satin acrylic tray for 2 A4 sized literature, these trays are adjustable horizontally and in height.

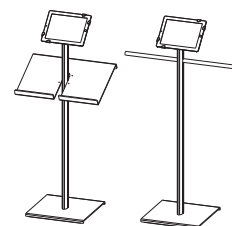

other possible combinations!

ulteriori informazioni pag. 257  
mehr details s. 257  
more information p. 257

257

## pad woman

1	PWL1145	pad woman, 1pc
2	SOTR2A4TR	tray 2A4, 1pc



**NEW PRODUCT**

1 + 2  
pad woman + tray 2A4

## information

stampa a iniezione dei materiali sintetici, alluminio anodizzato color argento, base in metallo con copertura in abs

*kunststoff-spritzguss, silber eloxiertes aluminium, bodenplatte aus metall mit abs abdeckung*

**synthetic die-cast, silver anodized aluminium, weight plate made of metal with abs cover**

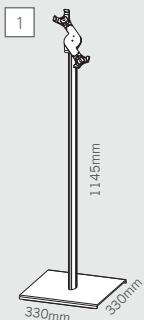



2  
ipoint media 17"



# ipoint media

MADE IN EU design by KD

**IT** ipoint media per presentazioni audiovisive attira l'attenzione con il suo look elegante in nero e gli schermi da 12.1." o 17". potete completare il vostro ipoint media anche con ripiani o barre laterali. comunicateci già al momento dell'ordine quali accessori desiderate, così da potervelo predisporre già in fase di produzione. per motivi tecnici di produzione, l'allestimento di ipoint media con ulteriori accessori non è possibile dopo l'assemblaggio.

**DE** ipoint media für die audiovisuelle präsentation in elegantem schwarz begeistert durch 12.1" bzw. 17" lcd schirm. optional statten wir die ipoints mit prospekt ablagen oder display bars aus. einfach bei bestellung mitteilen, welche optionals sie wünschen. unsere produktion wird dies bei der montage entsprechend vorsehen. ein nachrüsten ist aus montagetechnischen gründen nicht möglich.

**EN** ipoint media for the audiovisual presentation wows you and your customers with its elegant look and the 12.1" resp. 17" screens. optional the ipoint media can be upgraded with brochure trays or display bars. let us know with your order which options you like. we will prepare your ipoint accordingly. due to production-related reasons it is not possible to upgrade the ipoint media after assembling.



sul retro si trova l'interfaccia per la memory card o usb e l'uscita per il cavo

*auf der rückseite befindet sich die schnittstelle für memory card oder usb sowie der kabelausgang*

**on the rear side you find the interfaces for memory card or usb and the exit of the cable.**

## ipoint media

1	IPM12	ipoint media 12.1", 1pc	
2	IPM17	ipoint media 17", 1pc	



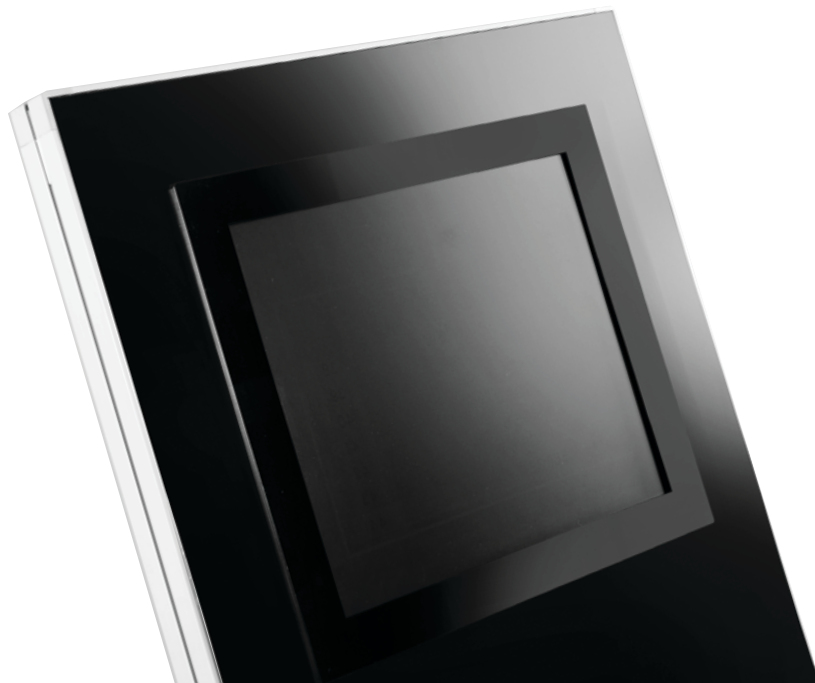

panel size	12.1 TFT LCD	17-inch TFT LCD
panel resolution	720x576	1280x1024
compatible file formats	photo: JPEG, music: MP3, video: AVI (video codec MPEG 1/2, MPG4, Dvix, Xvid) (video tag MPEG 1/2, MPG4, Dvix, Xvid)	photo: JPEG, music: MP3, video: AVI (video codec MPEG 1/2, MPG4, Dvix, Xvid) (video tag MPEG 1/2, MPG4, Dvix, Xvid)
adjust	contrast, viewing angle, colour	contrast, viewing angle, colour
auto slide show	supported	supported
background music	supported	supported (WMA file)
aspect ratio	4:3	4:3
brightness	350MCD	500MCD
viewing angle	60:60	80:60
speaker	2x2W built in	2x2W built in
remote control	infrared	infrared
external memory card - excl.	SD, MMC, MS, USB, XD	SD, MMC, MS, USB, XD, CF
features	time, calendar, alarm clock	time, calendar, alarm clock

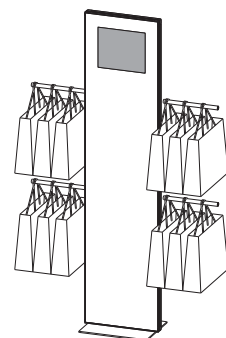
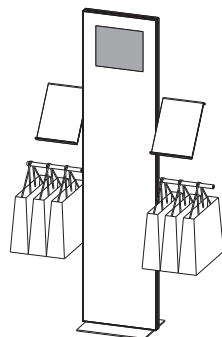
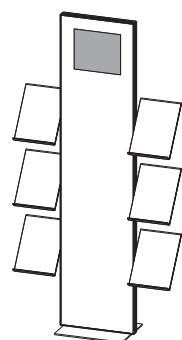

## information

base in metallo verniciato a polvere di color nero, estrusioni in alluminio anodizzato color argento, pannelli alubond color nero con schermo lcd

basis metall schwarz pulver beschichtet, rahmen silber eloxiertes aluminium, schwarzes aluminium verbundpaneel mit lcd bildschirm

black powder coated metal base, frame silver anodized aluminium, black aluminium composite panel with lcd screen

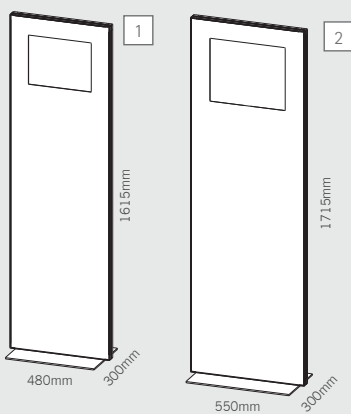

# tv bond soistes

MADE IN EU design by KD

**IT** tv bond l'espositore mobile per flatscreen con pannello di alluminio composito. un lato del pannello è decorato in color argento metallizzato, mentre l'altro è bianco per un'eventuale personalizzazione con stampa digitale o laminato. stabile struttura in alluminio anodizzato color argento della serie soistes con ruote.

**DE** tv bond, das mobile flatscreen-display mit aluminium-verbundpaneel. das paneel hat zwei seiten: dekoratives silbermetallic oder mattweiss für ihre personalisierung mit digitaldruck oder aufkaschierung. stabile struktur mit silber eloxiertem aluminiumprofil aus der soistes serie auf rollen.

**EN** the tv bond, the mobile flatscreen display with aluminium composite panel. the panel has two sides: one with decorative silver metallic and the other in white matt for customization with digital printing or laminating. stable structure made of silver anodized aluminium of the soistes series on stable coasters.



1  
soistes tv bond

flatscreen tv not included



## information

alluminio anodizzato color argento, pannello alu-bond bifacciale color argento/bianco, supporto per tv in metallo nero, piedi in metallo verniciato a polvere color nero con copertura in alluminio anodizzato, ruote

*silber eloxiertes alu-profil, alu-bond paneel silber/weiss, tv-halter schwarz, füsse pulverbeschichtetes schwarzes metall mit silber eloxierter alublende, rollen*

**silver anodized aluminium profile, aluminium comp. panel silver/white, tv-mount black, feet black powder coated metal with silver anodized aluminium cover, coasters**

tv-mount for flatscreen  
screen size: 30" - 62"  
inclination: +10°/- 0°  
max load: 75kg

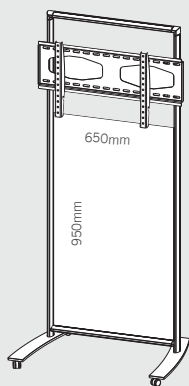

stabile espositore per TV su ruote dotate di sistema frenante.

*stabile leichtlaufrollen mit fest-stellbremse*

**stable coasters with locking brake**

tv bond soistes

1 SOTVB1800

tv bond, 1pc



flatscreen tv not included

## tv rack soistes

MADE IN EU design by KD

**IT** tv rack l'espositore mobile con ripiani in vetro satinato, serigrafato sul retro in color bianco con marchio. il supporto per la tv e i ripiani sono regolabili in altezza sul profilo a proprio piacimento. la struttura è realizzata con profili in alluminio anodizzato color argento della serie soistes.

**DE** tv rack mobiles flachbildschirm-display mit rückseitig weiss besiedruckten glasfachböden mit logo. flachbildschirm-halter und fachböden sind stufenlos höhenverstellbar. struktur aus silber eloxierten aluminiumprofilen der soistes serie.

**EN** tv rack mobile flat screen display with tempered glass shelves, bottom side white silk screen printed with brand. flat screen support and shelves can be infinitely adjusted in height. the structure is made of silver anodized aluminium extrusions of the soistes series.

### information

tv-mount for flatscreen  
screen size: 30" - 62"  
inclination: +10°/- 0°  
max load: 75kg

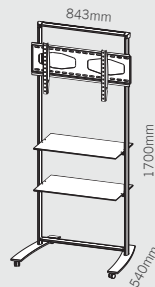

### tv rack soistes

1 SOTVR1800

tv rack, 1pc



## tv wall

MADE IN CHINA quality control by KD

**IT** tv wall per il montaggio diretto a parete di schermi piatti, in metallo verniciato a polvere color nero con livella a bolla integrata.

**DE** der tv wall zur direkten wandmontage von flachbildschirmen in schwarz mit integrierter wasserwaage.

**EN** tv wall for direct wall mounting of flat screens in black coated metal and with integrated spirit level.

### information

tv-mount for flatscreen  
screen size: 30" - 62"  
inclination: +10°/- 0°  
max load: 75kg  
wall distance: 50mm

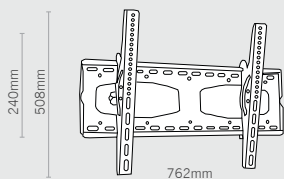

### tv wall

2 SOTVWSZ

tv wall support black, 1pc





# postfix

MADE IN EU controlled by KD

**IT** la combinazione di profili in alluminio anodizzato color argento, angoli in policarbonato trasparente e morsetti a coccodrillo è ideale per informazioni che vengono cambiate con una certa frequenza. per messaggi pubblicitari, foto, immagini ma anche come elemento decorativo per esporre tessuti, postfix fa al caso vostro. gli accessori consentono il montaggio a parete, a soffitto, su vetro, su cavi di acciaio o l'uso da banco.

**DE** kombination aus silber eloxiertem aluminium, transparenten polycarbonatecken und krokodilklemmen, genau das richtige für information, die unkompliziert gewechselt werden soll. für info- und bildmaterial oder als dekoelement mit stoffen oder folien. mit zubehör für counter, wand, spannseil und glas.

**EN** combination of silver anodized aluminium profiles with transparent polycarbonate connectors and alligator clips, the right choice for information that can be changed easily. not just information and images, but also as decorative element with fabric. accessories for counter, wall, suspension or glass.

postfix

1	POSTFIXA4	A4, 1pc	
2	POSTFIXA3	A3, 1pc	
3	POSTFIXA1	A1, 1pc	
4	POSTFIX700500	700mmx500mm, 1pc	
5	POSTFIX1000700	1000mmx700mm, 1pc	
6	POSTFIXFGARset	spacers for wall and cable, set 1x4pcs	

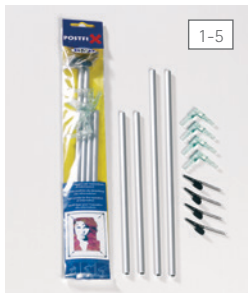

1-5

profilo ovale in alluminio anodizzato, 4 trasparenti angoli in policarbonato e morsetti a coccodrillo con molla.

*ovales profil aus silbereloxiertem aluminium, vier verbindungscken aus transparentem polycarbonat und krokodilklemmen mit feder.*

**oval silver anodized aluminium profile, 4 transparent polycarbonate connectors and croco clips with spring**



6

fissaggi in ottone cromato color argento satinato con anellini trasparenti, per il fissaggio a parete o su cavi di acciaio in confezione a 10 set di 4 pezzi l'uno, completi di viti e tasselli per il montaggio

*halter aus silber matt verchromtem messing mit transparenten o-ringen, zur befestigung an wand und seil, konfektion 10 set à 4 stück, komplett mit schraube und dübel*

**spacers in silver matt chrome plated brass with transparent o-ring, for wall and cable mounting, box with 10 set with 4 pieces each, screws and dowels included**

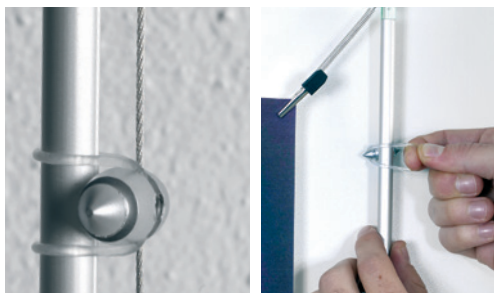

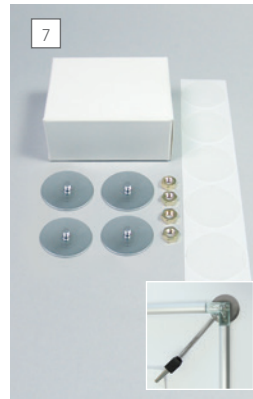

rossett: sistema di montaggio su vetro con biadesivo o colla, in ottone cromato, per superfici lisce, confezione a 10 set di 4 pezzi l'uno

rossett: aufklebbare Befestigungshilfe messing verchromt, für glatte Oberflächen, box mit 10 sets à 4 st

rossett: mounting support to glue on chrome-plated brass, for smooth surfaces, box with 10 sets with 4 pcs each.



espositore da banco: cavo in acciaio inox, Ø3mm, 190mm, adatto solo per postfix A3 verticale e A4 orizzontale e verticale

tischaufsteller: bügel aus niro edelstahl, Ø3mm, 190mm, nur für A3 vertikal, A4 horizontal und vertikal

for counter and table: stainless steel support, Ø3mm, 190mm, use only with postfix A3 vertical, A4 horizontal and vertical



ventose trasparenti, Ø40mm, per il fissaggio su superfici lisce, in confezione a 10 set di 4 pezzi l'uno

transparenter saugnapf, Ø40mm, für die Befestigung auf glatten Oberflächen, box mit 10 sets à 4 stk

transparent suction cup, Ø40mm, for mounting on plain surfaces, box with 10 sets with 4pcs each



tirante per cavi fly loop per fissaggio a soffitto. ottone color argento satinato, per cavi di acciaio con spessore max. ø2mm, materiale di montaggio incluso

seilhalter fly loop für die deckenmontage. silber veredeltes messing, für stahlseile max. ø2mm, inkl. montage material.

cable fastener fly loop for ceiling. silver plated brass, for cables max. ø2mm, mounting material incl.

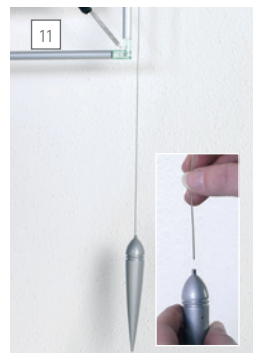

loop lot YL18110AR in ottone cromato color argento satinato assicura la giusta tensione ed il giusto peso nella parte inferiore della struttura

das gewicht loop lot YL18110AR aus silbermatt verchromtem messing sorgt für die richtige spannung

loop lot YL18110AR made of silver matt chrome plated brass gives the required weight to the suspension system

## for the ceiling ... wall and on the table

**IT** postfix è ideale anche per il fissaggio a parete o a soffitto, grazie agli accessori della serie loop, sviluppata come sistema modulare, dove sia sempre possibile aggiungere nuove parti e creare nuove configurazioni. oltre che per applicazioni a parete, postfix loop consente anche di realizzare divisori di spazio e separatori trasparenti con cui arredare lo showroom, l'ufficio o il negozio.

**DE** postfix ist ideal für decken- oder wandabhängung. mit den befestigungen der loop serie geht alles ganz einfach und wir haben das loop-system so gebaut, dass sie jederzeit um neue module erweitern können. ideal ist postfix mit loop nicht nur für die wandgestaltung. auch transparente raumteiler und luftige trennwände lassen sich schnell für showroom, office und shop gestalten.

**EN** postfix is perfect for suspending from the wall or ceiling. mounting is no problem with the fasteners of the loop series. we made the loop system modular so that it can be enlarged anytime you want. postfix with loop is not only the perfect way to fashion walls but also ideal to design transparent room dividers and breezy partitions in showroom, office and shop.

## postfix

7	FROS25CMset	mounting support on glass, 4pcs	
8	POSTFIXBG	steel support for counter, only A4 and A3	
9	AVEN4040set	suction cups, 4pcs	
10	YLOOPARset	fly loop silver, set 1x2pcs	
11	YL18110AR	fly loop lot, 1pc	





3  
bannerblock 1000mm

banner not included

# bannerblock

MADE IN EU design by KD

**IT** bannerblock è indubabilmente IL profilo per le vostre stampe digitali. i due profili in alluminio anodizzato color argento tensionano perfettamente le vostre stampe con spessore da 0,2 a 0,7mm, lungo tutto la loro lunghezza. gli occhielli in materiale plastico per il fissaggio a soffitto sono compresi nel set di profili, ai quali possono venir semplicemente agganciati con un clic. I formati più comuni sono disponibili a magazzino come set completi anche con occhielli e chiavetta per aprire il profilo, mentre per le vostre esigenze fuori standard ci sono le barre a metro

**DE** DAS klemmprofil für ihre digitaldruckpräsentation. silber eloxierte aluminium profile klemmen drucke von 0,2 bis 0,7mm auf ganzer länge sicher ein. kunststoffösen für die deckenabhängung sind im lieferumfang dabei und können einfach eingeklipst werden. bannerblock gibt es in gängigen längen als doppel-set inclusive ösen und praktischem profil-öffner.

**EN** THE profile for your digital print presentation. silver anodized aluminium extrusions clamp the full length of your prints with thicknesses from 0,2 to 0,7mm. the synthetic eyelets included for suspension from ceiling can be simply clipped on. bannerblock is available in common lengths as 2 piece set with eyelets and convenient profile opener.

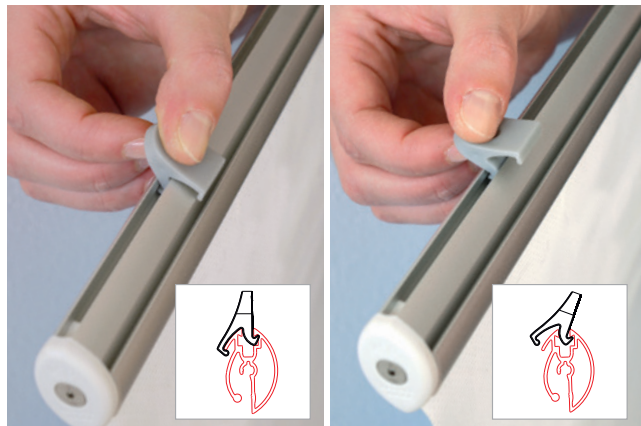
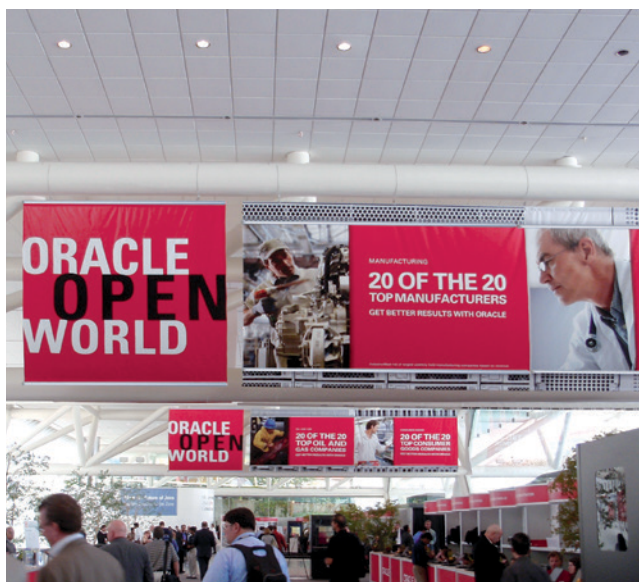

## bannerblock

1	BBC500	for 500mm
2	BBC700	for 700mm
3	BBC1000	for 1000mm
4	BBC1200	for 1200mm
5	BBC1500	for 1500mm
6	BBC2000	for 2000mm

1-6



profili in alluminio anodizzato color argento, tappi laterali e occhielli in materiale plastico, chiavetta per aprire il profilo.

*silber eloxierte aluminiumprofile mit kunststoff-kappen und -klippösen sowie profilöffner*

**silver anodized aluminium profiles with synthetic caps, eyelet clips and profile opener**





banner not included

# wall support

 MADE IN EU design by KD

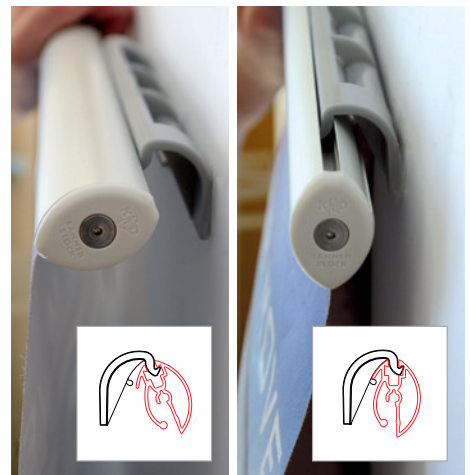

1



fissaggio a parte per bannerblock, in materiale plastico di colore grigio, materiale per il montaggio incluso. bannerblock, con o senza la stampa, può essere agganciato o sganciato in qualsiasi momento.

wandbefestigung für bannerblock, kunststoff grau inkl. montage-material. bannerblock mit und ohne banner kann jederzeit einfach ohne werkzeug ein- und ausgehängt werden.

wall support for bannerblock, grey synthetic incl. mounting material. bannerblock with or without banners can be easily attached anytime without further tools.

## bannerblock wall support

1 BBWS

bannerblock support 1pc

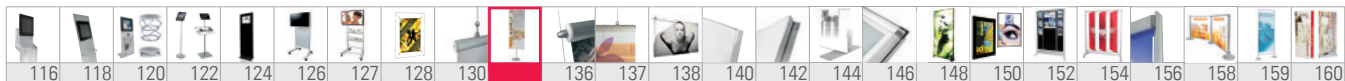

# bannerboy

MADE IN EU design by KD

**IT** bannerboy è il pratico display pronto per l'uso per le vostre stampe digitali mono- o bifacciali. il banner si tensiona in modo molto semplice grazie ai profili, i quali si agganciano poi altrettanto semplicemente all'asta telescopica. per una presentazione bifacciale, basta solo ordinare un ulteriore set di profili bannerblock nella lunghezza desiderata. il set bannerboy viene fornito con una pratica borsa, da utilizzare per il trasporto e lo stoccaggio del portabanner.

**DE** bannerboy display mit klemmprofil bannerblock für ein- und beidseitige digitaldruck präsentation. banner einfach mit den klemmprofilen montieren und an die struktur anklipsen. für die doppelseitige präsentation einfach ein weiteres set bannerblock in der gewünschten länge bestellen. die praktische tragetasche schützt ihren bannerboy bei transport und lagerung.

**EN** bannerboy display with clamp extrusion bannerblock for single and double sided digital print presentation. simply mount the banner to the extrusion and clip it to the structure. for a double side presentation simply order another set of bannerblock in the requested length. the convenient bag protects your bannerboy during transport and storage.



2  
bannerboy700

banner not included

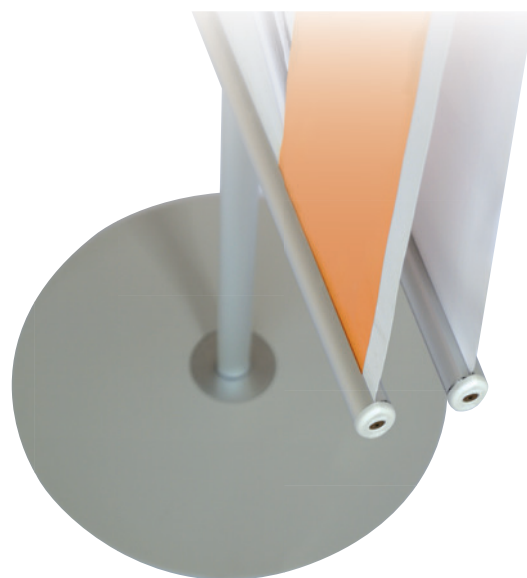

## bannerboy

1	BABN500	for 500mm	
2	BABN700	for 700mm	
3	BABN1000	for 1000mm	
4	BABBC	bannerboy connector clip, 1pc	
5	BBC500	bannerblock 500mm	
6	BBC700	bannerblock 700mm	
7	BBC1000	bannerblock 1000mm	





praticità: gancio in materiale plastico per presentazioni mono- e bifacciali

praktisch: ein halter für einseitige und doppelseitige präsentation

convenient: just one support for single and double side presentations

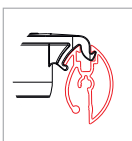
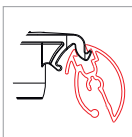

semplice da agganciare all'asta telescopica, senza viti o utensili

einfach einklippen, ohne schrauben und werkzeug

simply clip on, no screws or tools needed



per una presentazione bifacciale, basta solo ordinare un ulteriore set di profili bannerblock nella lunghezza desiderata ed un connettore a clip.

für die doppelseitige präsentation einfach ein weiteres set bannerblock und einen connector clip bestellen.

simply order another set of bannerblock in the requested length and a connector clip.

profili in alluminio anodizzato color argento, tappi laterali e occhielli in materiale plastico, chiavetta per aprire il profilo.

silber eloxierte aluminiumprofile mit kunststoff-kappen und -klippösen sowie profilöffner

silver anodized aluminium profiles with synthetic caps, eyelet clips and profile opener

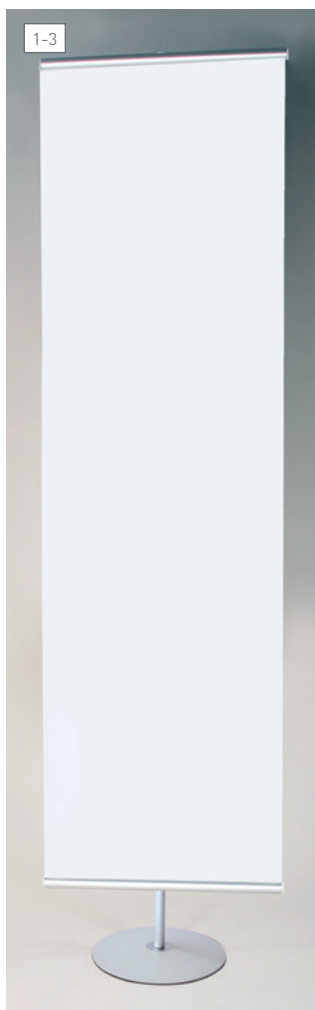

profili bannerblock in alluminio anodizzato color argento, asta telescopica, base in materiale plastico color grigio chiaro, borsa per il trasporto inclusa.

silber eloxierte aluminium profile bannerblock, teleskopstange, basis aus lichtgrauem kunststoff, incl. tragetasche

silver anodized aluminium profiles bannerblock, telescopic bar, base made of light grey synthetics, transport bag incl.



show zip





1

bannerboy 1300-2400mm



# bannerboy structure

 MADE IN EU design by KD

**IT** grazie a bannerboy e bannerblock potete addirittura costruire e formare vere e proprie pareti divisorie. proprio per questo utilizzo abbiamo realizzato e vi offriamo la struttura bannerboy. a seconda delle esigenze, potrete scegliere l'accessorio più adatto dal nostro assortimento bannerblock. se vi servono misure fuori standard, non esitate a chiedere, siamo volentieri a vostra disposizione.

**DE** sie können mit bannerboy und bannerblock auch modular wände bauen. dafür bieten wir ihnen hier die bannerboy struktur an. je nach bedarf wählen sie aus unserem bannerblock programm das benötigte zubehör. für ausserstandard längen fragen sie uns, wir beraten sie gerne.

**EN** you can build with bannerboy and bannerblock modular walls as well. for this we offer you the bannerboy structure. according to your needs choose freely from our bannerblock assortment of accessories. for non standard lengths please contact us directly.



transport bag incl

## bannerboy

1 BABN2400ELG

bannerboy structure, 1pc



# pole

MADE IN EU design by KD

**IT** pole, asta telescopica pratica e versatile, vi sostiene in ogni vostra creazione. nella parte superiore l'asta telescopica è dotata di un filetto. a scelta la base può essere fornita nella versione personalizzabile con l'inserto centrale in vetro o con il rivestimento in materiale plastico color grigio chiaro.

**DE** pole kann als teleskopische struktur ihre kreativität unterstützen: oben ist die teleskopstange mit einem gewinde ausgestattet. beim standfuss können sie zwischen der personalisierbaren version mit glaseinsatz oder der lichtgrauen kunststoff-basis wählen.

**EN** pole the telescopic structure supports your creativity: on top of the telescopic bar you find a thread. for the base you can choose between the customizable version with glass inlay or the cover made of light grey synthetic.

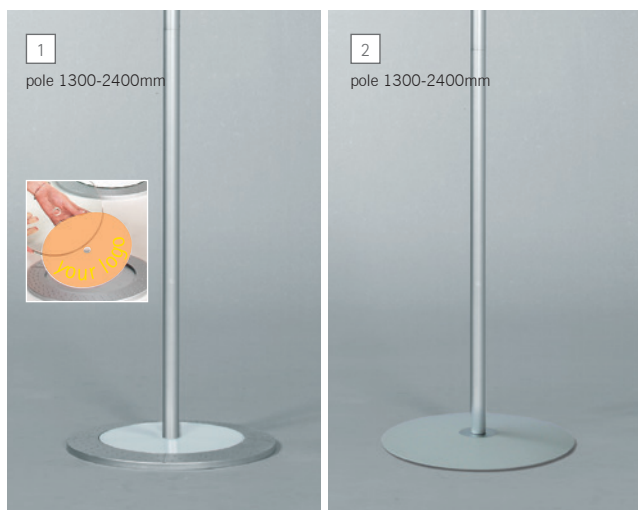

## pole

1	DPON2400VE	pole with glass inlay base, 1pc
2	DPON2400LG	pole with light grey base, 1pc





banner not included

# bannerblock® fly

MADE IN EU design by KD

**IT** bannerblock è ideale anche per applicazioni su cavi di acciaio. che si tratti di stampe singole o di composizioni modulari, grazie agli elementi della linea fly potrete integrare il vostro bannerblock e le vostre stampe digitali a qualsiasi sistema in tensione su cavi. fissate bannerblock al cavo di acciaio con sidefix. i teli si possono cambiare velocemente in qualsiasi momento. date un'occhiata al capitolo fly, dove troverete una vasta scelta di accessori per sistemi in tensione su cavi.

**DE** bannerblock bietet sich insbesondere auch für die montage von digitaldrucken am seilspannsystem an. ob einzelne drucke oder modulare gestaltung, mit den befestigungselementen der linie fly integrieren sie bannerblock und ihre digitaldrucke in alle informationssysteme am spannsel. mit sidefix befestigen sie die profile am seil. die drucke lassen sich jederzeit austauschen. schauen sie mal ins kapitel fly, dort finden sie eine umfassende auswahl für alles rund ums spannsel.

**EN** bannerblock is also ideal for mounting digital prints to cable rod systems. single prints or modular design, with the elements of the fly range you integrate easily bannerblock and your digital prints to all information systems on cable. mount the extrusions with sidefix to the cable. the prints can be exchanged anytime. have a look at the chapter fly, there you find a huge choice of fixings all about cable rod systems.



profilo bannerblock in combinazione con sidefix per sistemi in tensione su cavi di acciaio

bannerblock in kombination mit sidefix für seilspannsysteme

bannerblock in combination with sidefix for cable suspension systems

## bannerblock

1	BBC500	bannerblock for 500mm
2	BBC700	bannerblock for 700mm
3	BBC1000	bannerblock for 1000mm
4	BBC1200	bannerblock for 1200mm
5	BBC1500	bannerblock for 1500mm
6	BBC2000	bannerblock for 2000mm
7	YSF1315ARset	sidefix silver, set 1x4pcs
8	YM3050ARset	mobil silver, set 1x2pcs
9	AFIL05	steel cable, roll 5m
10	AFIL25	steel cable, roll 25m
11	ABOB500	steel cable, roll 500m



profili in alluminio anodizzato color argento, tappi laterali e occhielli in materiale plastico, chiave per aprire il profilo.

silber eloxierte aluminiumprofile mit kunststoff-kappen und -klippösen sowie profilöffner

silver anodized aluminium profiles with synthetic caps, eyelet clips and profile opener



sidefix color argento fissaggio su cavi, confezione 10set con 4pz cad.

sidefix silber bestigung für seilmontage, konfektion mit 10 set à 4st

sidefix silver mounting support for cable, box 10set of 4pcs each



mobil color argento fissaggio a parete e soffitto per cavi, confezione 5set con 2pz cad.

mobil silber decken- und wandhalter für seil, konfektion mit 5 set à 2st

mobil silver ceiling- and wall-support for cable, box 5set of 2pcs each



cavo di acciaio rot.

stahlseil rolle 500m/25m/5m

steel cable roll 500m/25m/5m





# posterblock

MADE IN EU design by KD

**IT** cercate un'alternativa facile e veloce per poster, foto o informazioni in generale? posterblock è l'ideale per qualsiasi realizzazione grafica che abbia fino ad 1 mm di spessore. il profilo ad incastro in materiale plastico è disponibile trasparente o in colore nero. il fissaggio avviene in un batter d'occhio, sia a parete che a soffitto, grazie agli occhielli trasparenti da inserire nella parte superiore del profilo.

**DE** sie suchen eine leichte alternative für die präsentation von poster, foto oder information generell? posterblock ist das richtige für alle grafiken mit einer stärke bis zu 1mm. die klemmschiene aus kunststoff erhalten sie in schwarz oder transparent. mit den transparenten ösen zum einklicken an wand oder decke schnell befestigt.

**EN** looking for a lightweight way to present posters, images or information in general? then take posterblock and you are alright for images up to 1mm thickness. the snap-shut synthetic profile is available in black or transparent. click in the transparent eyelets and mount posterblock on wall or ceiling.

digi

1

2

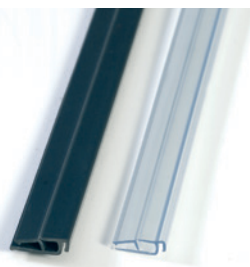

profilo ad incastro in mat. plastico, 5 pezzi di 3m l'uno in col. nero PB3000SZ o trasparente PB3000TR

*kunststoffklemmprofil, 5stk à 3m in schwarz PB3000SZ und transparent PB3000TR*

**snap-shut synthetic profile, 5pcs with 3m each in black PB3000SZ and transparent PB3000TR**

3



set per il fissaggio composto da 2 occhielli trasparenti e da 2m di filo in nylon, confezione a 10 set

*befestigungs-set mit je 2 ösen transparent und je 2m nylonfaden, konfektion mit 10 sets*

**mounting set with 2 transparent eyelets and 2m nylon thread each, box with 10 sets**

4



20pz occhielli per il fissaggio, in materiale plastico trasparente

*20stk befestigungs-ösen, kunststoff transparent*

**20pcs eyelet for fastening, transparent synthetics**

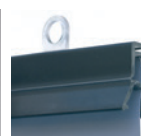

introdurre il materiale nel posterblock aperto

*material in den geöffneten posterblock einführen*

**insert the image into the open posterblock**



chiudere il posterblock esercitando una lieve pressione con un click

*posterblock mit sanftem klick schliessen*

**smoothly click to close the posterblock**



## posterblock

1	PB3000SZ	profile black, 5pcs x 3000mm	
2	PB3000TR	profile transparent, 5pcs x 3000mm	
3	PBSET10	mounting set with eyelet and nylonthread, 10sets	
4	PBHK20TR	transparent eyelets, box 20pcs	



# backframe

MADE IN EU design by KD

**IT** backframe provvede egregiamente al fissaggio, tra gli altri, di pannelli flessibili e sottili, come per esempio i semi espansi, il forex o l'alluminio, perché assicura una tenuta perfetta, semplice ed estremamente sicura. particolarmente pratico è il sistema di livellatura che backframe offre e che può essere regolato fino a 10 mm, in modo che il vostro pannello sia sempre appeso dritto in modo perfetto, senza dover riforare il muro per riattaccarlo. offriamo backframe come set completo nei formati più comuni; in caso di richiesta sono disponibili altre lunghezze per formati su misure.

**DE** backframe sorgt als ein befestigung v.a. für flexible, dünne paneele z.b. aus hartschaum, forex oder aluminium für die nötige versteifung. zugleich befestigt der backframe ihr paneel sicher und einfach. besonders praktisch dabei die nivellierung fürs aufgehängte paneel, die vertikal bis zu 10mm unterschied reguliert, so dass ihr paneel immer gerade hängt ohne dass neu gebohrt werden muss. wir bieten ihnen backframe als komplettes set für gängige formate an. ausserdem erhalten sie auch alle seitenlängen extra für weitere formate.

**EN** backframe is a mounting system especially for thin and flexible panels made of hard-foam, forex or aluminium. it helps to stiffen the panel, while mounting is easy and safe. the leveling system is particularly convenient for the mounted panel, that can even be up to 10mm, so that your panel will always be straight without drilling new holes. we provide you with complete sets for common formats. also available are all lengths extra to create new sizes.

## information

included

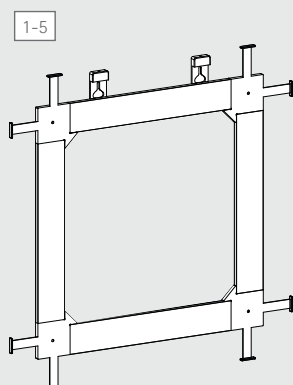

4 profili in alluminio anodizzato color argento, 4 angolari in materiale plastico, quantità necessaria per livellatura a parete e una cacciavite

4 silber eloxierte aluminiumprofile, 4 kunststoff eckverbinder, entsprechende nivellierungs-wandhaken, und ein inbus-schlüssel

4 silver anodized aluminium profiles, 4 plastic edge connectors, needed quantity of leveling wall hooks, and one required key

## backframe complete

1	FBAFA3	complete set for A3, 1pc
2	FBAF700500	complete set for 700x500mm, 1pc
3	FBAFA1	complete set for A1, 1pc
4	FBAF1000700	complete set for 1000x700mm, 1pc
5	FBAF14001000	complete set for 1400x1000mm, 1pc

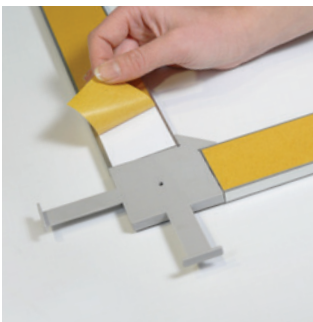
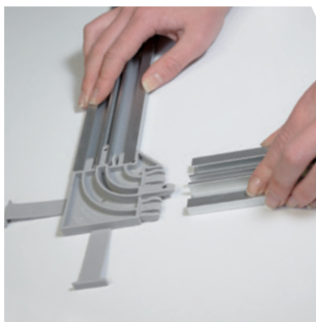

costruire la cornice, applicare il biadesivo, posizionare la cornice sul muro grazie al sistema di alette laterali per il montaggio, staccare tali alette e attaccare il pannello alla parete.

*rahmen zusammenbauen, doppel-klebeband aufbringen, rahmen mittels montagehilfen positionieren, montagehilfen abreißen, paneel aufhängen*

assemble the frame, put on the double sided adhesive tape, position the frame with the positioning straps, tear away straps, wall mount the panel

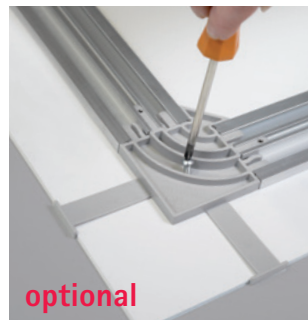

**optional**

l'angolo della struttura può anche essere avvitato al pannello.

*optional kann der eckverbinder auch direkt mit paneel verschraubt werden*

you have the option of also screw the edge connector directly to the panel

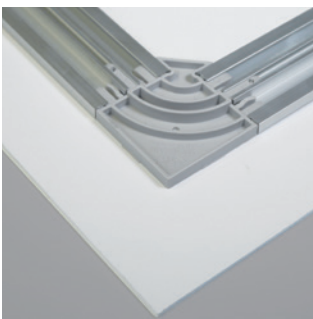
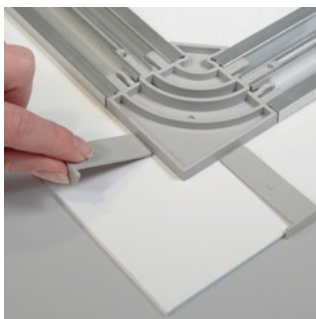
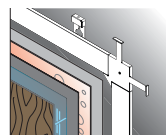

fissaggio a parete con livellatura: corregge dislivelli fino a 10mm dopo il montaggio

*wandbefestigung mit nivellierung: gleicht bis zu 10mm nach montage aus*

wall hook with levelling: evens up to 10mm after wall mount

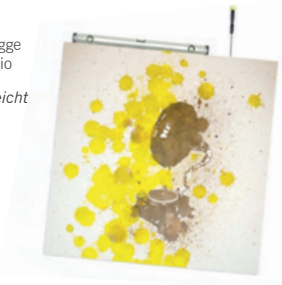

- ✓ per il fissaggio di pannelli sottili e flessibili
- ✓ *befestigung und versteifung dünner, flexibler paneele*
- ✓ mounting and strengthening of thin, flexible panels
- ✓ pratico sistema di montaggio
- ✓ *praktische montage-hilfe*
- ✓ convenient positioning straps
- ✓ sistema di livellatura regolabile
- ✓ *regulierbare horizontale nivellierung*
- ✓ adjustable horizontal leveling

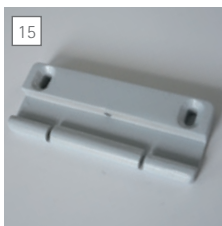

agganci a parete a prova di furto non livellabili in altezza, materiale plastico

*wandhaken mit diebstahlsicherung, nicht höhen-nivellierbar, kunststoff*

wall hook with theft protection, without leveling, synthetic



14  
cacciavite da ordinare a parte  
*inbus-schlüssel bitte extra bestellen*  
order the required key separately

## backframe modular

6	FBAFSA3	set for 297mm, 1set
7	FBAFLA3	set for 420mm, 1set
8	FBAF500	set for 500mm, 1set
9	FBAFSA1	set for 594mm, 1set
10	FBAF700	set for 700mm, 1set
11	FBAFLA1	set for 841mm, 1set
12	FBAF1000	set for 1000mm, 1set
13	FBAF1400	set for 1400mm, 1set
14	ACHI20	allen key, 1pc
15	FBAFSH	wall lock, 2pcs

## information

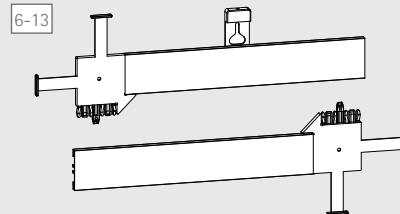

included

2x



2x



2 profili in alluminio anodizzato color argento, 2 angolari in materiale plastico, quantità necessaria per livellatura a parete

*2 silber eloxierte aluminiumprofile, 2 kunststoff eckverbinder, entsprechende nivellierungs-wandhaken*

2 silver anodized aluminium profiles, 2 plastic edge connectors, needed quantity of leveling wall hooks

ulteriori informazioni pag. 351  
mehr details s. 351  
more information p. 351

351



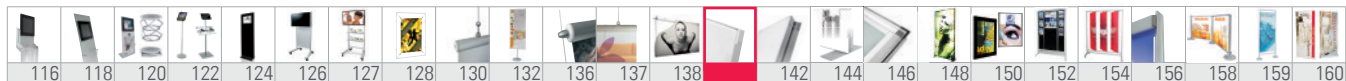

**NEW  
PRODUCT**



banner not included

# monoframe

MADE IN EU design by KD

**monoframe**

**IT** il monoframe è la soluzione perfetta per la decorazione e l'allestimento delle pareti grazie alla stampa di alta qualità su tessuto. il design discreto della cornice lascia l'immagine in primo piano. l'alluminio anodizzato color argento e gli angoli realizzati in metallo pressofuso garantiscono una lunga durata del prodotto. grazie alle strisce in silicone cucite al banner in tessuto la sostituzione dello stesso potrà avvenire in qualsiasi momento in modo facile, veloce e senza l'utilizzo di utensili.

**DE** monoframe ist die perfekte lösung für die dekorative wandgestaltung mit ihrem hochwertigem textildruck. ein schlankes design lässt den rahmen dezent in den hintergrund treten. das motiv steht im vordergrund. hochwertige materialien wie silber eloxiertes aluminium und metall-druckguss-ecken garantieren lange freude an diesem system. der textile banner wird dank der flachkeder schnell und einfach befestigt. so ist auch der austausch ohne demontage und werkzeug im nu erledigt.

**EN** monoframe is the perfect solution for your decorative wall elements with your high-grade print on fabric. a lean design keeps the frame in the background, while the image is in the center of attention. high-quality materials as silver anodized aluminium and die-cast metal corner connectors guarantee a long life-time. the textile banner is easily mounted thanks to the silicone strips. thus the exchange is quick and easy without any tools anytime.

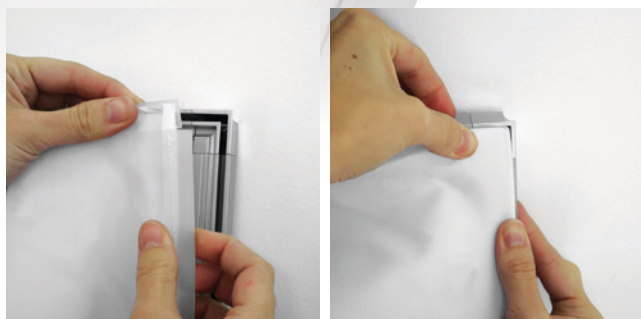

## information

profili in alluminio anodizzato color argento, angoli in metallo pressofuso color argento opaco

silber eloxierte aluminium-profile, silbermatt veredelte metall-druck-guss-eckverbinder

silver anodized aluminium profiles, silver matt plated zamac edge connectors

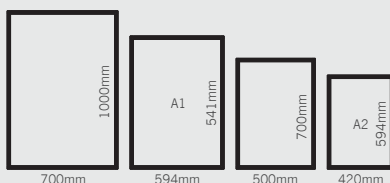

profili in alluminio anodizzato color argento, angoli in metallo pressofuso color argento opaco, connettori

silber eloxierte aluminium-profile, silbermatt veredelte metall-druck-guss-eckverbinder, traversen-verbinder aus kunststoff

silver anodized aluminium profiles, silver matt plated zamac edge connectors, synthetic cross beam connectors

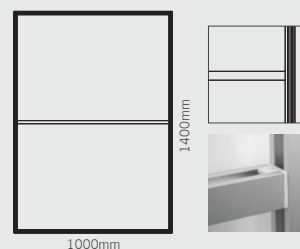

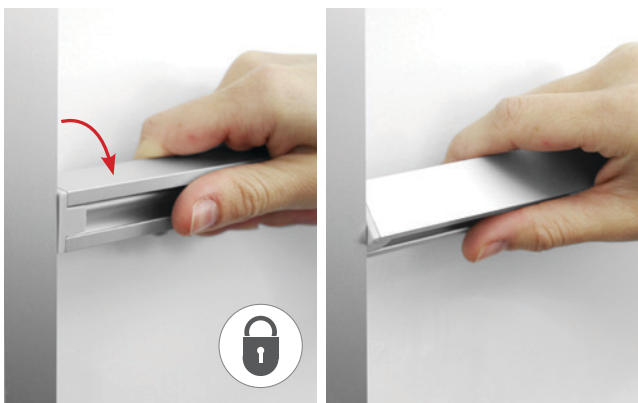

l'aggiunta delle traverse è sempre possibile grazie all'intelligente sistema ad incastro; le traverse sono invece già incluse nel formato 1000x1400

*einsetzen der traversen dank cleverem stecksystem jederzeit möglich, traversen sind beim format 1400x1000 bereits enthalten*

cross struts can be mounted anytime thanks to the clever plug in system, the size 1400x1000 comes already with cross struts



montaggio a parete semplice e veloce grazie agli occhielli

*schnell und einfach wandbefestigt dank der integrierten ösen*

quick and easy wall mounting thanks to the integrated eyelets



monoframe <sup>1)</sup>

1	MFRA2	monoframe A2, 1pc	
2	MFR700500	monoframe 700x500mm, 1pc	
3	MFRA1	monoframe A1, 1pc	
4	MFR1000700	monoframe1000x700mm, 1pc	
5	MFR1400100	monoframe1400x1000mm, 1pc	

1) in vendita da maggio 2013 | auslieferung ab märz 2013 | on sale from march 2013



## information

frame length = profile + 44mm

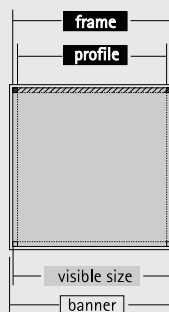

banner = visible size + 20mm

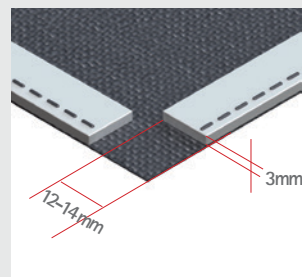



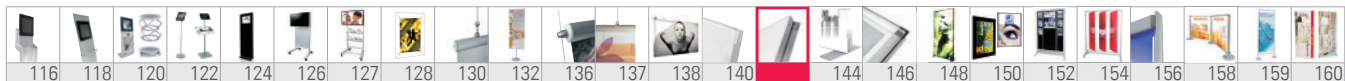

banner not included

## framframe wall

MADE IN EU design by KD

**IT** framframe wall è perfetto per una moderna decorazione delle pareti tramite banner in tessuto. i profili in alluminio anodizzato color argento sono dotati frontalmente di apposite cave per fissare il tessuto rivestito di strisce di silicone. frontalmente il profilo è visibile per soli 2mm, un cornice elegante ma discreta. internamente la struttura può essere irrobustita grazie a delle traverse di alluminio, che si possono aggiungere al sistema in qualsiasi momento, senza doverlo smontare.

**DE** framframe wall ist perfekt für trendige wand-dekoration mit bedruckten stoffbannern. die silber eloxierten aluminiumprofile haben frontal entsprechende einstecknuten für textilbanner mit silikonlippe. frontal verbleiben vom aluminiumprofil nur 2mm als elegante umrahmung des banners sichtbar. versteift wird das system mit aluminium-traversen, die jederzeit ohne demontage des rahmens positioniert werden können.

**EN** framframe wall is perfect for the stylish wall decoration with fabric banners. the silver anodized aluminium extrusions have on the front the required notches to insert textile banners with a silicone seam. only 2mm of the aluminium profile will remain visible, thus elegantly framing the banner. the system can use struts as cross beams made of silver anodized aluminium, that can be positioned every time without any disassembling of the frame to keep the banner under tension.

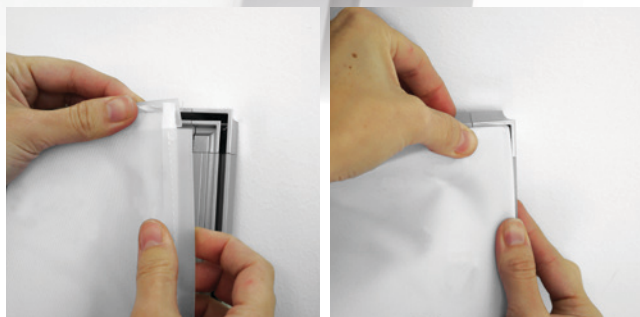

### information

profili in alluminio anodizzato color argento, angoli in metallo pressofuso color argento opaco.

*silber eloxierte aluminium-profile, silbermatt veredelte metall-druckguss-eckverbinder*

**silver anodized aluminium profiles, silver matt plated zamac edge connectors**

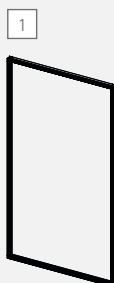

profili in alluminio anodizzato color argento, angoli in metallo pressofuso color argento opaco, connettori delle traverse in materiale plastico.

*silber eloxierte aluminiumprofile, silbermatt veredelte metall-druckguss-eckverbinder, traversenverbinder aus kunststoff*

**silver anodized aluminium profiles, silver matt plated zamac edge connectors, synthetic cross beam connectors**

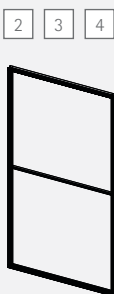

profili in alluminio anodizzato color argento, angoli in metallo pressofuso color argento opaco, connettori

*delle traversen silber eloxierte aluminiumprofile, silbermatt veredelte metall-druckguss-eckverbinder, traversenverbinder aus kunststoff*

**silver anodized aluminium profiles, silver matt plated zamac edge connectors, synthetic cross beam connectors**





banner not included



l'aggiunta delle traverse , grazie all'intelligente sistema ad incastro, è possibile in qualsiasi momento.

*einsetzen der traversen dank cleverem stecksystem jederzeit möglich*

**cross beams can be mounted anytime thanks to the clever plug system**

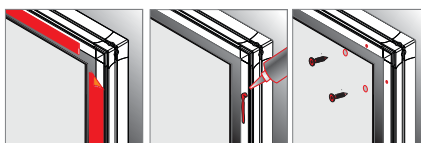
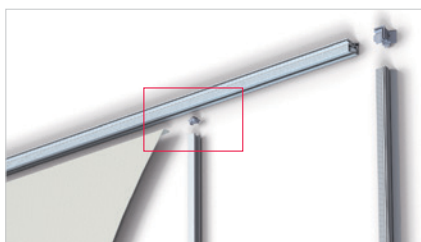

### information

frame length = profile + 60mm

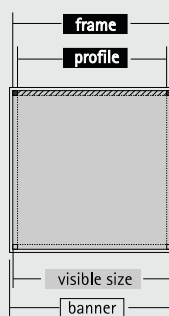

banner = visible size + 20mm

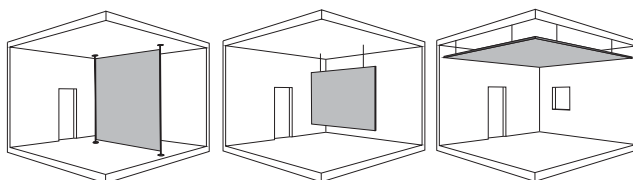
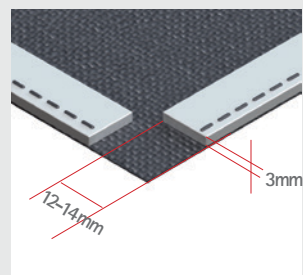

### framframe

1	FFR1500500	framframe 1500x500mm, 1pc	
2	FFR2000800	framframe 2000x800mm, 1pc	
3	FFR20001000	framframe 2000x1000mm, 1pc	
4	FFR25001500	framframe 2500x1500mm, 1pc	
5	FFR25002500	framframe 2500x2500mm, 1pc	
6	FFR30002500	framframe 3000x2500mm, 1pc	
7	FFRWS	framframe wallsupport, 2pcs	

7

### wall support

fissaggio murale in metallo verniciato color argento  
wandhalter aus silberlackiertem metal  
wall support made of silver varnished metal





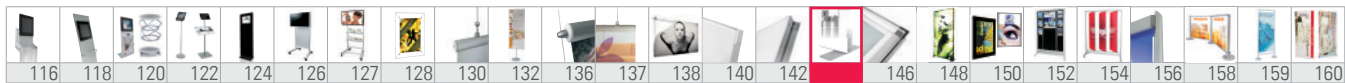

3 + 7  
framframe 2000x1000mm +  
framframe base

banner not included

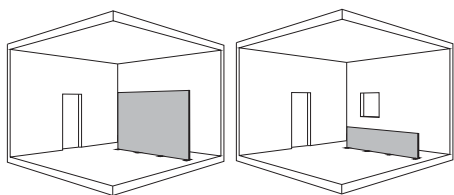

## information

profili in alluminio anodizzato color argento, angoli in metallo pressofuso color argento opaco.

*silber eloxierte aluminiumprofile, silbermatt veredelte metall-druckguss-eckverbinder*

**silver anodized aluminium profiles, silver matt plated zamac edge connectors**

1-6

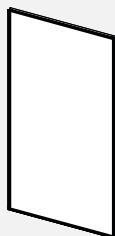

# framframe floor

MADE IN EU design by KD

**IT** framframe floor può essere utilizzato con banner in tessuto mono- o bifacciali per creare espositori da terra autoportanti. i banner in tessuto sono sostituibili in modo veloce e in qualsiasi momento senza bisogno di smontare la struttura e ricorrere ad utensili. funge da parete divisoria, elemento decorativo o spazio pubblicitario. frontalmente sono visibili solo 2mm della cornice: i motivi rappresentati danno quindi l'idea di essere sospesi – la cornice passa in secondo piano.

**DE** framframe floor können sie ein- oder beidseitig mit textilen bannern für dekorative freistehende bodendisplays verwenden. die bedruckten stoffbanner können sie jederzeit schnell, ohne demontage und ohne werkzeug austauschen. ideal als raumteiler, dekoratives element oder werbefläche. frontal gesehen sind nur noch 2mm rand von der struktur sichtbar: die motive wirken autonom - das system hält sich diskret im hintergrund.

**EN** framframe floor you can use single- or double side with fabric banner for decorative freestanding floor displays. the printed banners can be exchanged quickly anytime without any tools. perfect as a partition, decorative element or advertising space. from the head-on view you see only 2mm of the structure: the images act for themselves - the framframe system steps back discreetly.

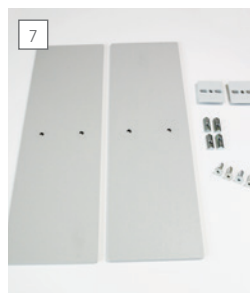

## floor base

base di appoggio in metallo verniciato color argento  
*bodenplatte aus silberlackiertem metall*  
**floor plate made of silver varnished metal**



## framframe freestanding

1	FFR1500500	framframe 1500x500mm, 1pc
2	FFR2000800	framframe 2000x800mm, 1pc
3	FFR20001000	framframe 2000x1000mm, 1pc
4	FFR25001500	framframe 2500x1500mm, 1pc
5	FFR25002500	framframe 2500x2500mm, 1pc
6	FFR30002500	framframe 3000x2500mm, 1pc
7	FFRB300100	framframe base, 2pcs



banner not included

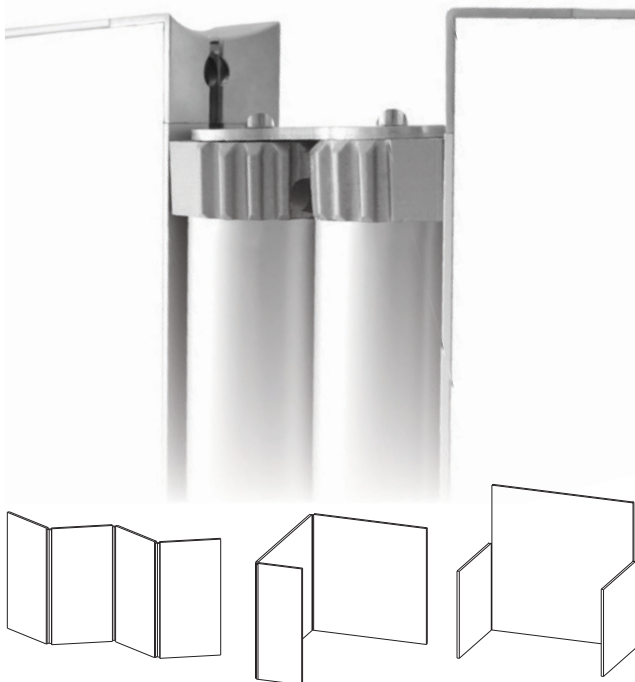

## framframe multi

MADE IN EU design by KD

**IT** sfruttate pienamente il vostro framframe: per adattamenti e modifiche ci sono ora i connettori framframe multi. In questo modo sarà possibile trasformare il vostro framframe floor o framframe silentArt in pratiche pareti divisorie. non ci sarà bisogno di smontare la cornice per aggiungerci le cerniere e creare una nuova combinazione di elementi. è possibile ruotare la parte di connessione di 360° in entrambe le direzioni. parete divisoria, angolo per riunioni, sala d'attesa, stand per fiere e molto altro è realizzabile in modo molto veloce e flessibile grazie al sistema framframe.

**DE** machen sie mehr aus ihrem framframe: einfach zum nachrüsten gibt es die framframe multi verbinder. so machen sie aus ihren framframe floor oder framframe silentART elementen modulare raumtrenner. ohne demontage der rahmen können sie die framframe multi scharniere an die rahmen montieren und die elemente miteinander verbinden. die verbindung lässt sich stufenlos in beide richtungen um 360° bewegen. raumtrenner, besprechungsecken, wartebereich, messtische und vieles mehr wird mit framframe multi schnell und flexibel realität.

**EN** make more out of your framframe: simply expand your framframe floor or framframe silentART elements into modular partitions. without dismantling the structure you can mount the hinges to the frames and connect the elements. the connection can be moved in both directions stagelessly with 360°. partition, meeting corner, waiting area, exhibition booths and much more becomes reality in a quick and flexible way with framframe multi.

### information

alluminio anodizzato color argento, materiale sintetico color grigio stampato ad iniezione, connettore a 360°

silber eloxiertes aluminium, grauer kunststoff-spritzguss, 360° verbindung

silver anodized aluminium, grey die-cast synthetics, 360° connection

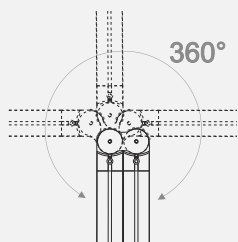

### framframe multi <sup>1)</sup>

1	FFC1260	1260mm, 1pc
2	FFC1500	1500mm, 1pc
3	FFC1900	1900mm, 1pc
4	FFC2000	2000mm, 1pc

1) in vendita da aprile 2013 | auslieferung ab april 2013 | on sale from april 2013



**NEW  
PRODUCT**

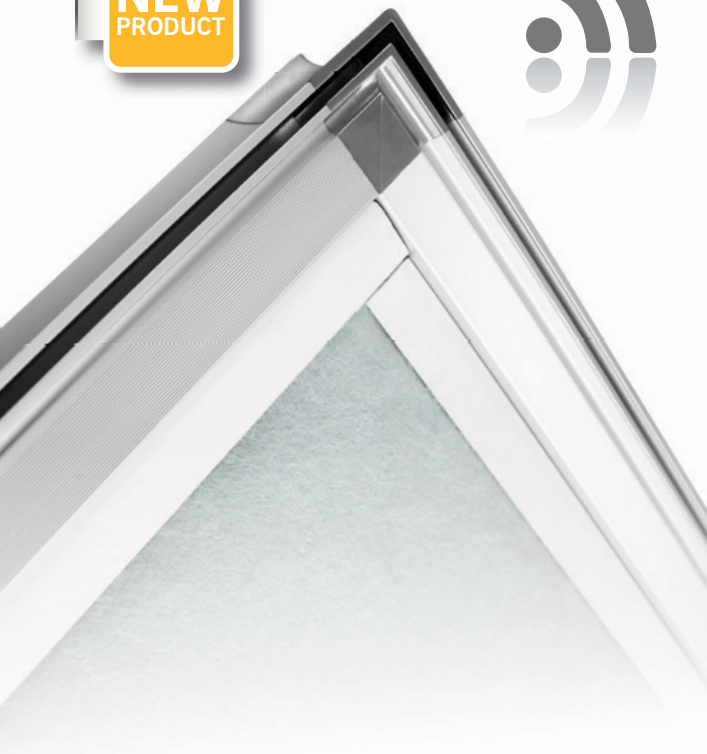

banner not included

## framframe silentART



MADE IN EU design by KD



profili in alluminio anodizzato color argento, angoli in metallo pressofuso color argento opaco, nucleo fonoassorbente

*silber eloxiertes aluminium, silbermatt verchromte eckverbinder aus metall-druckguss, schallschluckender kern*

**silver anodized aluminium, silver matt plated corner connectors made of metal die-cast sound absorbing core**



### free standing

base di appoggio in metallo verniciato color argento  
*bodenplatte aus silberlackiertem metall*

**floor plate made of silver varnished metal**

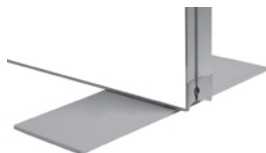

### on the wall

per il fissaggio a parete agganciare nella apposita sede

*zur wandbefestigung in die nut einhängen*  
**attache to the notch for wall mounting**

**IT** una decorazione per interni con un nucleo intelligente: dietro il tessuto stampato in digitale troverete materiale isolante fonoassorbente. potrete usare i prodotti silentART come pareti divisorie flessibili, decorazioni di tendenza a parete o a sospensione. il banner in tessuto può essere cambiato facilmente in modo da rendere sempre attuale questo prodotto per l'insonorizzazione degli spazi. silentART: più benessere nel vostro ambiente.

**DE** coole dekoration mit intelligentem kern: hinter dem bedruckten stoff steckt eine schall-absorbierende isolierung. sie können silentART produkte als flexible raumtrenner, dekorative wandgestaltung oder trendige deckenabhängung verwenden. der stoff lässt sich leicht austauschen, so bleibt dieser lärmschutz immer aktuell und wird nie langweilig. silentART: die intelligente lösung für mehr wohlfinden im raum.

**EN** a cool interior with an intelligent core: behind the digital printed textile there is noise absorbing isolating material. you can use the silentART products as flexible partition, decorative wall design or trendy ceiling suspension. the textile banner can be exchanged easily. this is a noise reducing product with an always up-to-date style. silentART: more wellness in your rooms.

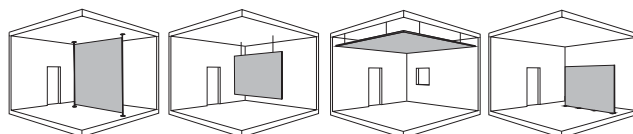



banner not included

**information**

frame length = profile + 60mm

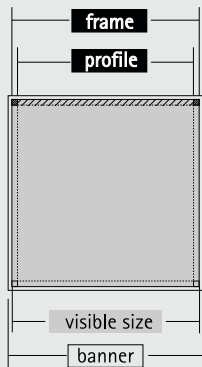

banner = visible size + 20mm

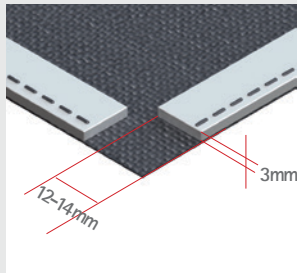

inserire il banner di tessuto con le strisce di silicone partendo dagli angoli.

*stoffbanner mit silikonlippe von den ecken ansetzend frontal einsetzen.*

textile banners are mounted easily with silicone seam starting from the edges



145

connector

framframe silentART

1	FFSI660660	silentART 660x660mm, 1pc	
2	FFSI1260660	silentART 1260x660mm, 1pc	
3	FFSI12601260	silentART 1260x1260mm, 1pc	
4	FFSI1900660	silentART 1900x660mm, 1pc	
5	FFSI19001260	silentART 1900x1260mm, 1pc	
6	FFRB300100	framframe base, 2pcs	





banner not included

# framframe LED

MADE IN EU design by KD



**IT** il nostro sistema framframe perfettamente illuminato a led presenterà le vostre stampe mono- o bifacciali su tessuto. i led di alta qualità faranno risaltare i colori delle vostre stampe. il sistema a cornice in alluminio anodizzato color argento comprende all'interno una lastra a diffusione di luce in PMMA incisa, con inserimento di led circolari trilaterali. se intendete utilizzare il display da terra solo da un lato, è sufficiente sostituire il banner in tessuto posteriore con una lastra in compensato. framframe led attirerà l'attenzione anche se montato a parete. sia come display da terra autoportante che come modello da parete, framframe led rappresenta una scelta brillante!

**DE** perfekt ausgeleuchtet präsentiert das framframe system mit led ihre textilen drucke ein- oder zweiseitig. hochwertige led lassen ihre farben strahlen. das rahmen system aus silber eloxiertem aluminium enthält in der mitte eine gravierte acrylglas streuscheibe mit dreiseitig umlaufenden led. möchten sie das boden-display nur einseitig verwenden, bringen sie einfach statt des textilen banners auf der rückseite eine verbundplatte an. auch für die wand ist framframe led ein toller hingucker. ob als freistehendes boden display oder als wand-motiv, framframe led ist eine brillante wahl!

**EN** the framframe system with led presents your prints on textile banners single or double sided perfectly illuminated. high class led let your colours shine. the frame system made of silver anodized aluminium contains an engraved acrylic diffusion plate leds on 3 sides. if you want to use the floor display only single-side simply mount to the rear side a composite panel instead of a textile banner. also for the wall framframe is a real eye catcher. framframe led is your brilliant choice for illuminated floor or wall displays!

## on the wall

fissaggio murale in metallo verniciato color argento  
wandhalter aus silberlackiertem metal  
wall support made of silver varnished metal



## information

profili in alluminio anodizzato color argento, angoli di connessione realizzati in metallo pressofuso, impreziositi da argento satinato, lastra a diffusione di luce in PMMA inciso, led circolari trilaterali

silber eloxierte aluminiumprofile, silber-matt veredelte metall-druckguss-ekverbinder, gravierte acrylglas streuscheibe, 3-seitig umlaufende LED

silver anodized aluminium profiles, silver matt plated zamac edge connectors, engraved acrylic diffusion with 3 side LED

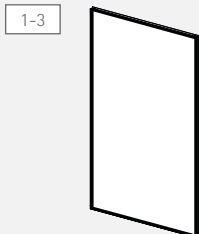

presentazione eccellente con luci led di qualità: 240led/m

brillante presentazione mit hochwertigen led-leuchten: 240led/m

brilliant presentation with first choice led-lights: 240led/m

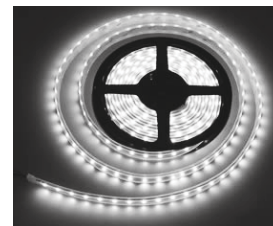

## framframe LED

1	FLD1800600 *	framframe LED 1800x600mm, 1pc
2	FLD1800800 *	framframe LED 1800x800mm, 1pc
3	FLD20001000 *	framframe LED 1800x800mm, 1pc
4	FLDWH	framframe LED wallsupport, 4pcs
5	FLDB300100	framframe LED base, 4pcs

\* in vendita da aprile 2013 | auslieferung ab april 2013 | on sale from april 2013



banner not included

### support freestanding

base di appoggio in metallo verniciato color argento  
*bodenplatte aus silberlackiertem metall*  
 floor plate made of silver varnished metal

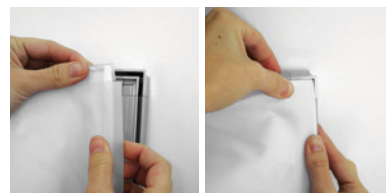
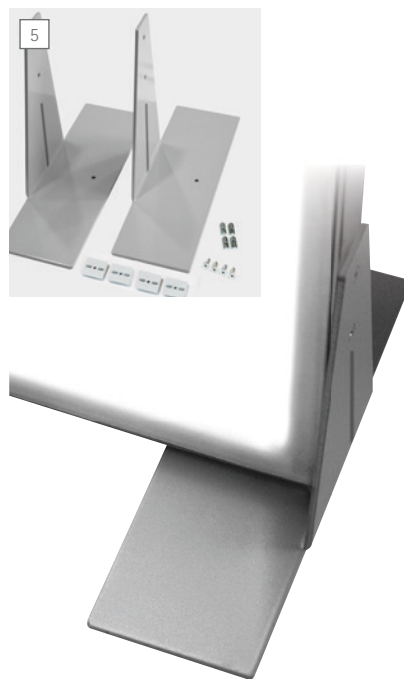

### information

frame length = profile + 60mm

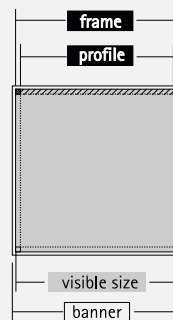

banner = visible size + 20mm

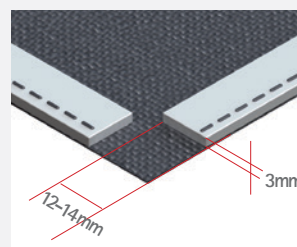





### information

cornice: alluminio anodizzato color argento, angoli in zamac color argento  
 rahmen: silber eloxiertes aluminium, versilberte eckverbinder aus metalldruckguss  
 frame: silver anodised aluminium profile, corner connectors made of zamac in silver

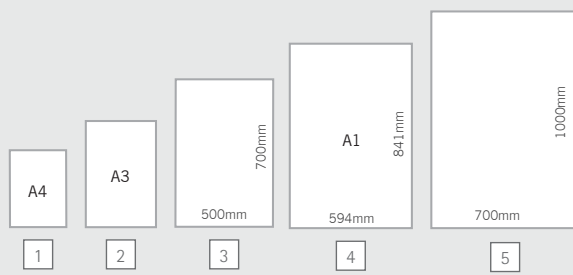

# lumo

MADE IN EU design by KD

**IT** lumo è il pannello illuminato da parete di prima classe. il pannello in acrilico di 8 mm al contrario dei pannelli serigrafati è inciso e questo garantisce una regolare ed uniforme illuminazione anche nei formati più grandi. i led che utilizziamo per lumo sono di alta qualità e garantiscono una lunga durata d'impiego. il foglio protettivo flessibile in policarbonato è resistente ai raggi uv e grazie al sistema di chiusura magnetica può essere sollevato in parte o completamente, rendendo così il cambio del manifesto rapido e semplice. il bordo laterale di 30mm serigrafato di colore nero è discreto e nel contempo elegante.

**DE** lumo für die wandmontage ist ein extra flaches leuchtpanel der sonderklasse. das 8mm starke acryl ist graviert und somit garantiert es im gegensatz zum siebdruck die gleichmässige und vollständige ausleuchtung der gesamten fläche. die hochwertigen LED haben eine sehr lange lebensdauer. die transparente und flexible folie aus polycarbonat ist uv-beständig. durch den magnetverschluss ist sie teilweise oder auch komplett abnehmbar und der austausch der information ist damit jederzeit schnell und unkompliziert möglich. das schwarze siebdruck passepartout ist mit geringen 30mm sehr dezent gehalten.

**EN** lumo für die wandmontage ist ein extra flaches leuchtpanel der sonderklasse. das 8mm starke acryl ist graviert und somit garantiert es im gegensatz zum siebdruck die gleichmässige und vollständige ausleuchtung der gesamten fläche. die hochwertigen LED haben eine sehr lange lebensdauer. die transparente und flexible folie aus polycarbonat ist uv-beständig. durch den magnetverschluss ist sie teilweise oder auch komplett abnehmbar und der austausch der information ist damit jederzeit schnell und unkompliziert möglich. das schwarze siebdruck passepartout ist mit geringen 30mm sehr dezent gehalten.

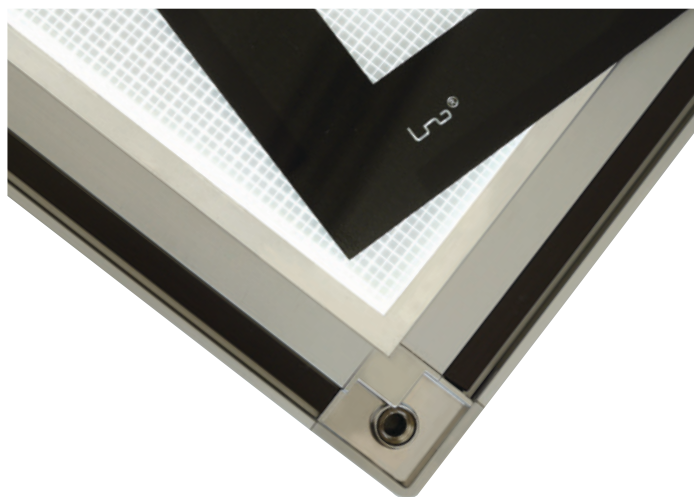

ulteriori informazioni pag.  
 mehr details s.  
 more information p.

324

## lumo



1	LUMORA4	lumo A4, 1pc
2	LUMORA3	lumo A3, 1pc
3	LUMOR700500	lumo 700x500mm, 1pc
4	LUMORA1	lumo A1, 1pc
5	LUMOR1000700	lumo 1000x700mm, 1pc

# lumo clipper

MADE IN EU controlled by KD

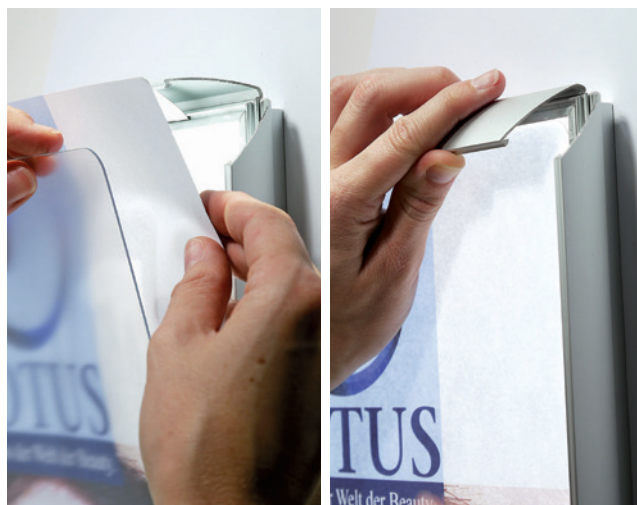

digi

**IT** il nostro lumo clipper è composto da una cornice a scatto completa di retroilluminazione a led. il foglio protettivo, in materiale sintetico trasparente a bassa riflessione, è resistente ai raggi UV. la cornice a scatto realizzata in alluminio anodizzato è una soluzione elegante, che mette in risalto la linea moderna del prodotto. questo sistema facilita la sostituzione di informazioni in modo veloce e semplice.

**DE** unser lumo clipper ist ein klapprahmensystem mit hinterleuchtung durch LED. die abdeckfolie ist aus uv-beständigem und reflektionsarmen transparentem kunststoff. der klapprahmen in elegantem silbereloxiertem aluminium unterstreicht den modernen look. ihre info können sie schnell und einfach jederzeit wechseln.

**EN** our lumo clipper is a clip frame system with back lighting by LED. the transparent cover is uv-resistant and non reflective. the clip frame made of silver anodized aluminium emphasizes the elegant look. your information is changed quickly and easily at anytime.



ulteriori informazioni pag. 322  
mehr details s. 322  
more information p. 322

322



## lumo clipper

1	LCLA4	lumo clipper A4, 1pc
2	LCLA3	lumo clipper A3, 1pc
3	LCLA2	lumo clipper A2, 1pc
4	LCL700500	lumo clipper 700x500mm, 1pc
5	LCLA1	lumo clipper A1, 1pc
6	LCL7001000	lumo clipper 700x1000mm, 1pc



NEW PRODUCT

2

lumo clipper A3

print not included

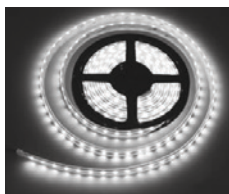
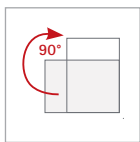
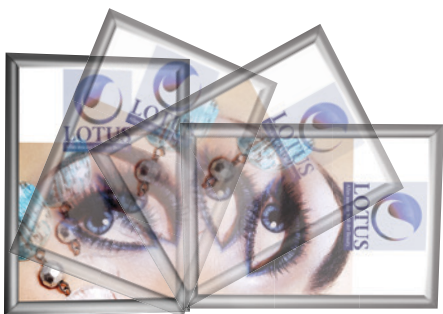

led-lights

presentazione eccellente con luci led di qualità

brillante präsentation mit hochwertigen led-leuchten

brilliant presentation with first choice led-lights

## information

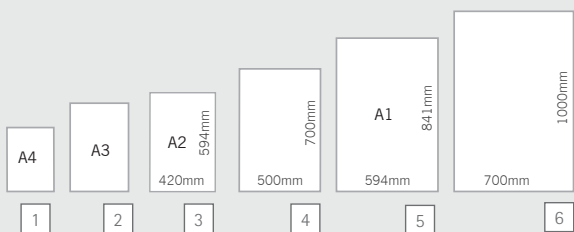



**NEW  
PRODUCT**



prints and banners not included

# lumo twist

MADE IN EU design by KD

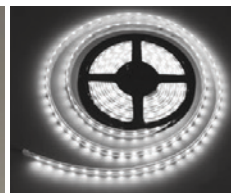

led-lights

presentazione eccellente con luci led di qualità

brillante präsentation mit hochwertigen led-leuchten

brilliant presentation with first choice led-lights

**IT** una soluzione elegante ed astuta, che combina un pannello luminoso con una stampa personalizzata su dibond o su banner in tessuto: gli elementi del pannello luminoso lumo sono ruotabili di 360° in passi di 22,5°. sono disponibili due misure per le cornici con due rispettivi moduli abbinabili. sul retro è possibile montare banner in tessuto o pannelli compositi. l'informazione nei pannelli luminosi lumo è facilmente sostituibile, grazie alla cornice frontale magnetica. lumo twist: per le vostre presentazioni di grande effetto.

**DE** eine elegante und pfiffige kombination aus leuchtpaneel und personalisierung mit druck auf dibond oder textilem banner: die elemente mit den leuchtpaneelen der lumo serie lassen sich um 360° drehen und rasten in 22,5° schritten ein. zur auswahl haben wir zwei grössen an rahmenstrukturen und je zwei module, die sie miteinander kombinieren können. auf der rückseite können sie entweder textile banner oder verbundpaneele montieren. die info in den lumo leuchtpaneelen wird dank des magnetisch befestigten passepartouts schnell gewechselt. der lumo twist: ein strahlender auftritt für ihre präsentation.

**EN** an elegant and smart combination of light panel and customization with print on dibond or textile banners: the structure with the light panels of the lumo series can be turned 360° and stop every 22,5°. for your choice we offer two sizes of frame structures and two elements that can be combined with each other. on the rear side of the structure you can mount either textile banners or composite panels. thanks to magnets the cover of the lumo light panels can be removed easily, allowing you to exchange the information quickly. the lumo twist: an illustrious appearance for your presentations.

## information

alluminio anodizzato color argento, connettori cromati color argento satinato. al momento dell'ordine si prega di indicare la posizione dei moduli per l'installazione dei cavi.

silber eloxiertes aluminium, silbermatt verchromte verbindler. bei bestellung position der module angeben für kabelverlegung

anodized aluminium, silver matt plated connectors. when ordering, indicate position of panels for correct cable settings

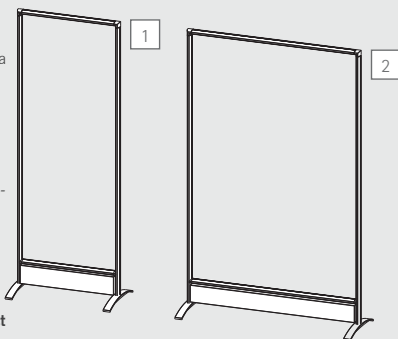

alluminio anodizzato color argento, connettori color argento satinato. al momento dell'ordine si prega di indicare la posizione dei moduli per l'installazione dei cavi.

lumo leuchtpaneel auf mattschwarzem alu-verbund-paneel, (rückseitig option für stoffbanner oder verbundpaneel - nicht im lieferumfang enthalten)

lumo light panel on matt black aluminium-composite panel. (rear part option for textile banner or panel - not included)

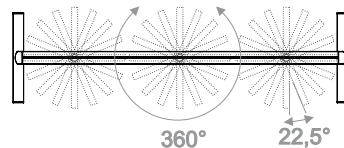
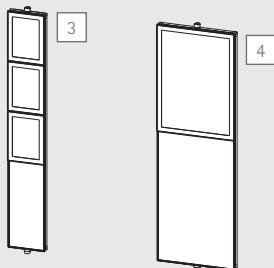

## lumo twist <sup>1)</sup>

1	SOCL2050720	lumo twist structure small, 1pc	
2	SOCL20501570	lumo twist structure big, 1pc	
3	SOCL3A4	lumo twist 3xA4, 1pc	
4	SOCL700500	lumo twist 700x500mm, 1pc	



1) in vendita da aprile 2013 | auslieferung ab april 2013 | on sale from april 2013



la cornice frontale magnetica rende la sostituzione delle vostre informazioni nei moduli luminosi semplice e facile

*magnethalterungen im passepartout machen den austausch ihrer info in den leuchtmodulen einfach und schnell*

magnetic supports in the cover foil make the exchange of your information in the light panels easy and quick

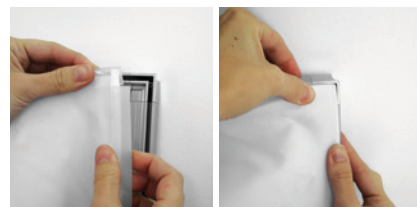

i banner in tessuto possono essere applicati sul retro in modo semplice e veloce, senza l' utilizzo di utensili

*textile banner können auf der rückseite einfach und schnell ohne werkzeug eingesetzt und ausgetauscht werden*

fabric banners can be easily attached and exchanged at anytime without the need for tools

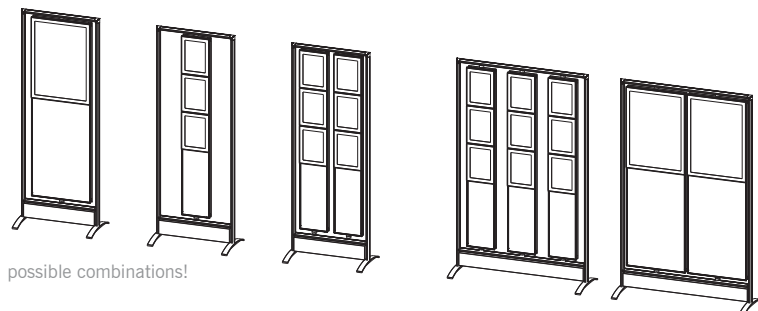



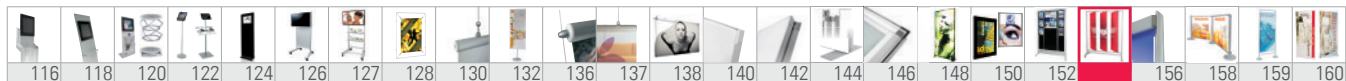

**NEW  
PRODUCT**



banner not included

# frame twist

MADE IN EU design by KD

**IT** mobile e versatile: la struttura soistes mobile è dotata di tre pannelli girevoli. il profilo frameframe permette di adattarvi banner bifacciali in tessuto. in alternativa potranno essere anche applicate stampe dirette su pannelli composti in alluminio, perfetti per la cornice framframe. tutti i materiali sono di alta qualità e resistenti. frame twist: impressioni ed espressioni che catturano lo sguardo!

**DE** mobil und wandelbar: die mobile soistes struktur mit drei frei schwenkbaren paneelen. auf die frameframe strukturen können sie doppelseitig textile banner anbringen. aber auch alu-verbundplatten mit druck passen zu den framframe rahmen. alle materialien sind hochwertig und langlebig. frame twist: immer wieder neue, überraschende einblicke und aussichten!

**EN** mobile and flexible: the mobile soistes structure with three freely rotatable panels. on the framframe structures you can mount on both sides fabric banners. but also aluminium composite panels with prints match perfectly. all materials are high-grade and long lasting. frame twist: new and surprisingly trendy insights and looks.



i banner in tessuto vengono inseriti frontalmente nella cava del profilo tramite strisce di silicone: partendo dagli angoli e senza utensili, in un batter d'occhio

*textile banner werden mittels silikonclipsen einfach frontal eingesetzt: beginnend von den ecken und ohne werkzeug einfach im handumdrehen*

**textile banners are simply attached from the corners: no tools needed and set up in no time at all**

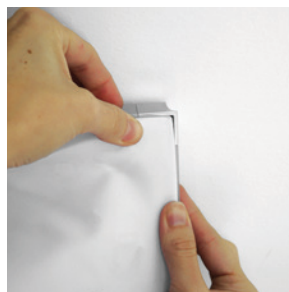

## information

liberamente girevole in entrambe le direzioni in passi di 22,5°

*frei schwenkbar in beide richtungen in 22,5° schritten*

**freely rotatable in both directions in 22,5° steps**

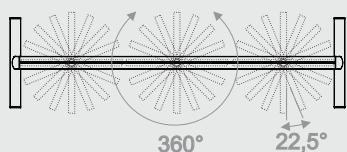
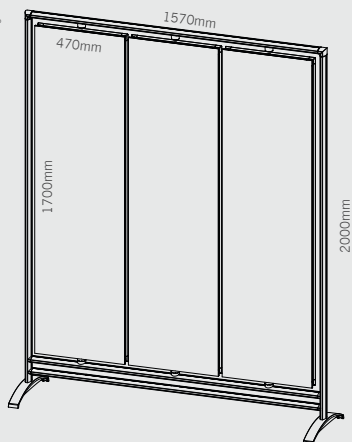

142

framframe

frame twist

1 SOCR20001570 \* frame twist, 1pc

\* in vendita da aprile 2013 | auslieferung ab april 2013 | on sale from april 2013



1  
frame twist

banner not included



profili in alluminio anodizzato, angoli ed accessori in metallo pressofuso color argento satinato

*silber eloxierte aluminium profile mit silbermatt verchromten metalldruckguss*

silver anodized aluminium profiles with silver matt plated die-cast metal

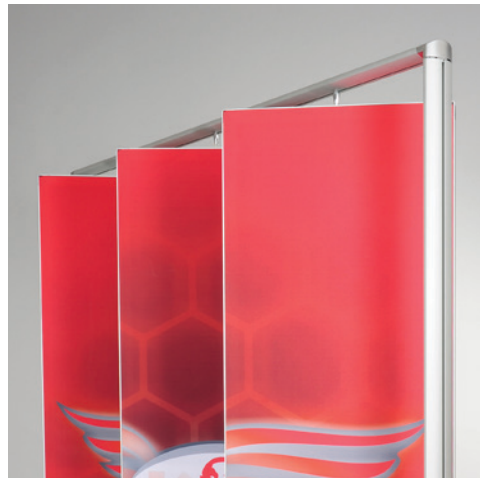

✓ mobile, flessibile, modulare  
mobil, flexibel, erweiterbar  
mobile, flexible, extendable

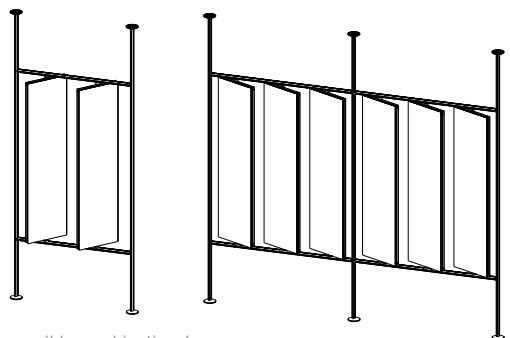

possible combinations!





regolabile e fissabile  
stufenlos ausziehen und feststellen  
stagelessly adjustable in length



## information

struttura mobile soistes in alluminio anodizzato color argento, connettori in metallo pressofuso, con ruote e sistema wallup.

mobile soistes struktur aus silber eloxiertem aluminium, silber matt verchromten metalldruckguss, leichtlaufrollen und wallup system

mobile soistes structure in silver anodized aluminium, silver matt plated die cast metal, castors and wallup system

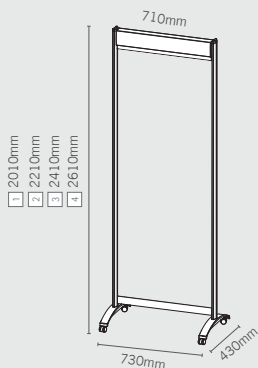

struttura mobile soistes in alluminio anodizzato color argento, connettori in metallo pressofuso, con ruote e sistema wallup.

mobile soistes struktur aus silber eloxiertem aluminium, silber matt verchromten metalldruckguss, leichtlaufrollen und wallup system

mobile soistes structure in silver anodized aluminium, silver matt plated die cast metal, castors and wallup system

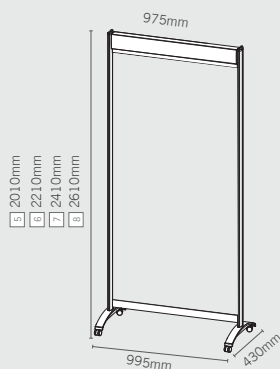

# wallup® soistes

MADE IN EU design by KD

**IT** il nostro sistema modulare soistes, usato in combinazione con wallup, si trasforma in un roll up di prima categoria. dopo l'inserimento del banner e il montaggio della struttura, il telo si svolge e si riavvolge facilmente e in qualsiasi momento. in questo modo il sistema è molto facile da utilizzare e veloce da installare. grazie alla modularità di soistes, wallup può sempre essere modificato ed integrato con nuovi moduli o accessori: combinando vari elementi si possono realizzare delle pareti divisorie, oppure dei veri e propri espositori per informazioni e cataloghi grazie ai ripiani e ai portadepliant della linea soistes.

**DE** unser einrichtungssystem soistes wird in der kombination mit wallup zu einem mobilen rollup der extra klasse. nach der bannermontage lässt sich das banner jederzeit leicht und schnell ausziehen und einhängen. dabei ist das ganze system einfach und in kurzer zeit aufgestellt. dank der modularität von soistes, ist wallup soistes jederzeit erweiter- und ausbaubar: aus mehreren elementen werden stellwände und mit den passenden ablagen und fachböden entsteht ein perfektes system für die info- und produktpräsentation.

**EN** our shop fitting system soistes becomes a first class mobile rollup in combination with wallup. after mounting, the banner can be easily extended and attached. the complete system sets up in a short time. thanks to the modular soistes system the wallup soistes can be added to at anytime: more elements can make movable walls while, with the matching trays and shelves, you can build a perfect information and product presentation system.



incollare il banner sulla barra di appoggio; appendere il supporto alla struttura. il banner può essere esposto alla lunghezza desiderata grazie al sistema di bloccaggio.

*banner auf die schienenhalterung kleben, halterung dann einfach einhängen. das banner kann wie ein rollo auf beliebige länge ausgezogen und arrettiert werden.*

**mount the banner to the rail support, then simply hang to the bottom cross bar. banner can be extended and locked in place like a roller blind**

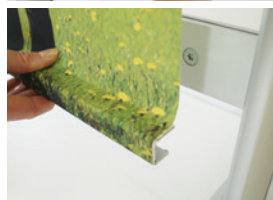

banner measure	banner visible size
1 1950x640mm	1800x640mm
2 2150x640mm	2000x640mm
3 2350x640mm	2200x640mm
4 2550x640mm	2400x640mm
5 1950x900mm	1800x900mm
6 2150x900mm	2000x900mm
7 2350x900mm	2200x900mm
8 2550x900mm	2400x900mm

## wallup soistes

1	SOWU2010710	wallup soistes 2010x710mm, 1pc
2	SOWU2210710	wallup soistes 2210x710mm, 1pc
3	SOWU2410710	wallup soistes 2410x710mm, 1pc
4	SOWU2610710	wallup soistes 2610x710mm, 1pc
5	SOWU2010975	wallup soistes 2010x975mm, 1pc
6	SOWU2210975	wallup soistes 2210x975mm, 1pc
7	SOWU2410975	wallup soistes 2410x975mm, 1pc
8	SOWU2610975	wallup soistes 2610x975mm, 1pc



1  
wallup soistes 2010x710mm

banner not included



struttura modulare facile e veloce da montare

modulare bauweise schnell und einfach aufgestellt

modular design: sets up quickly and easily

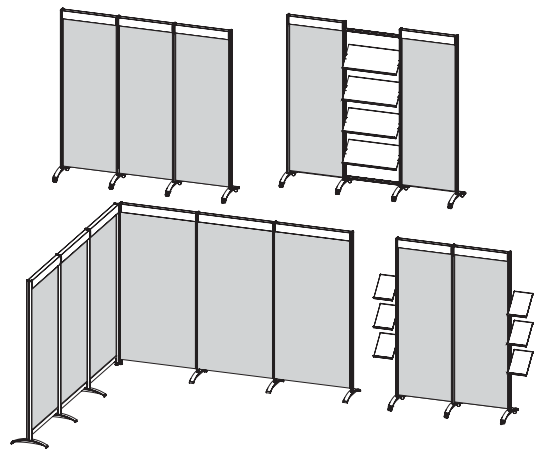
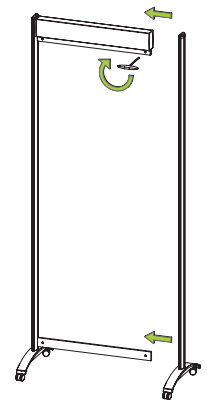

mobile, flessibile, modulare  
mobil, flexibel, erweiterbar  
mobile, flexible, extendable

### wallup soistes module

9	SOWU2010710M	wallup soistes module 2010x710mm, 1pc
10	SOWU2210710M	wallup soistes module 2210x710mm, 1pc
11	SOWU2410710M	wallup soistes module 2410x710mm, 1pc
12	SOWU2610710M	wallup soistes module 2610x710mm, 1pc
13	SOWU2010975M	wallup soistes module 2010x975mm, 1pc
14	SOWU2210975M	wallup soistes module 2210x975mm, 1pc
15	SOWU2410975M	wallup soistes module 2410x975mm, 1pc
16	SOWU2610975M	wallup soistes module 2610x975mm, 1pc

### information

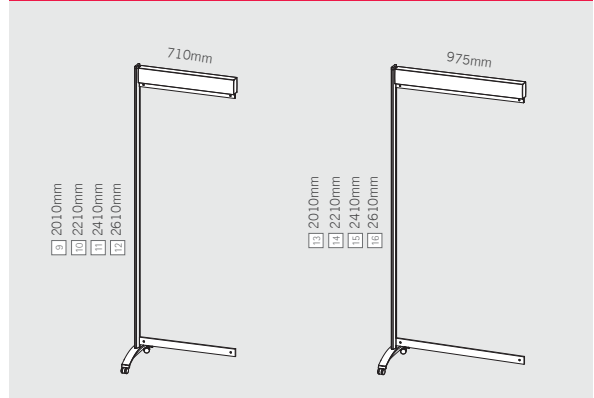





banner not included

# tex wall

MADE IN EU design by KD

**IT** presentazione con il sistema modulare texwall: tex wall abbina il sistema guidalinee tex con i profili ad incastro bannerblock. inserire i banner nei profili ed agganciarli. grazie ai supporti anulari, ogni modulo texwall può essere sistemato anche in maniera non lineare per creare pareti angolari o a „zigzag“. vi consigliamo gli accessori della serie tex anche per tex wall.

**DE** mit tex wall modular präsentieren: clevere kombi aus leitsystem tex mit klemmprofil bannerblock. banner in die profile einklemmen und einhängen. durch die ringförmigen halter, können sie jedes tex wall modul auch gewinkelt anfügen. unser tip: accessoires der stopper serie passen auch zu tex wall.

**EN** presentation with modular system tex wall: clever combination between queue management tex with bannerblock extrusion. clamp in the banner and simply attach it to the posts. thanks to the circular supports each texwall module can also be connected at angles. our tip: the accessories of the stopper range fit well tex wall also.

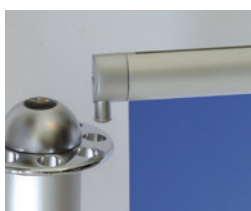

agganciare bannerblock alla ghiera, tenere il banner e fissare la ghiera sul tubo

*bannerblock im ring einhängen, spannen und fixieren*

**attach the bannerblock to the ring, then tighten the banner and fix the ring**



struttura modulare: combina il set base con il modulo di aggiuntivo

*modulare bauweise - basis set mit erweiterungsmodul kombinieren*

**modular set up: combine the base set with the extension module**

## information

tex wall: banner 850x900 (hxw).

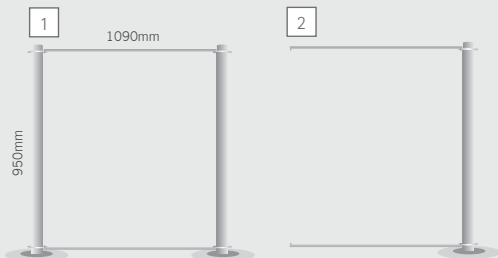

## tex wall

1	TXW950	tex wall 950x1090mm, 1pc
2	TXW950M	tex wall module 950mm h, 1pc



1  
print soistes



banner-not included

# print soistes

MADE IN EU design by KD

**IT** print soistes è il vostro espositore per stampe digitali. il fissaggio del banner è regolabile in altezza e permette l' utilizzo di stampe di varie lunghezze. il nostro consiglio: utilizzate un biadesivo con velcro per il fissaggio del banner. sfruttate il retro per renderlo bifacciale. profili in alluminio anodizzato color argento e basi con rivestimento esterno di protezione in abs.

**DE** print soistes - ihr digitaldruckpräseneter. die stufenlos höhenverstellbare bannerbefestigung erlaubt flexible bannerlängen. unser tip: verwenden sie für den saum klebeband mit klettverschluss. nutzen sie auch die rückseite mit druck für ihre präsentation. silber eloxierte aluminium profile und basen mit abs-trittschutz.

**EN** print soistes your digital print display. the freely adjustable banner supports allows for banner length flexibility. our tip: use adhesive tape with velcro for the seams and print also on the rear of your banner for double side presentations. silver anodised aluminum extrusions and bases with step-on protection made of abs..



profili in alluminio anodizzato color argento, base con protezione in ABS colore grigio, inserto decorativo in alluminio color argento

*silber eloxierte aluminiumprofile, basis mit ABS trittschutzring grau, dekorinlay aluminium silber eloxiert*

**silver anodized aluminium profiles, grey ABS-step-on protection ring with silver anodised aluminium decorative inlay**



il sistema laterale di fissaggio a molla tensiona perfettamente i vostri banner.

*gefederter befestigung, falten-lose spannung für ihr banner*

**spring loaded supports tenses your banner without creases**

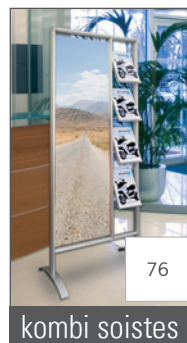

76

kombi soistes

## information

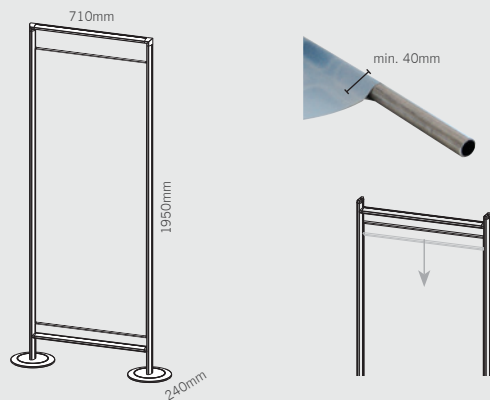

print soistes

1 SOPR1900650

print soistes, 1pc





1  
eLgrande

banner not included



facilità di montaggio: incollate o graffettate il banner alla striscia in pvc inclusa

leichte, unkomplizierte montage: banner auf das mitgelieferte pvc-profil kleben oder heften

easy and hassle-free mounting: just staple or glue to the pvc rails provided



2

grazie al connettore extend è possibile unire diversi eLgrande per soluzioni modulari. basta inserire extend nella cava posteriore del profilo e avvitarlo. set composto da 2 pezzi.

mit dem extend verbinder können sie mehrere eLgrande modular für wände zusammenstellen. einfach den extend verbinder rückwärts in der schiene positionieren und festschrauben. set mit 2stück

create modular walls with the connector extend. just insert extend into the rail and fasten. set with 2 pcs

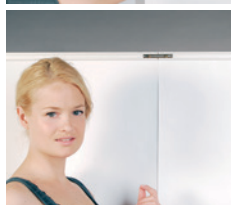

# eLgrande

MADE IN CHINA quality control by KD

**IT** eLgrande, l'espositore a L per banner, è semplice da utilizzare e da trasportare. È sufficiente graffettare o incollare il banner alle strisce in pvc incluse ed inserirle nei profili di alluminio. eLgrande si monta e si smonta facilmente e i banner si possono cambiare in modo semplice e veloce. l'asta telescopica assicura piena flessibilità nello scegliere l'altezza del banner, che inoltre rimane perfettamente in tensione. la robusta borsa in tessuto per il trasporto e lo stoccaggio è inclusa nella confezione.

**DE** eLgrande das L-bannerdisplay ist einfach und leicht bei handling und transport. das banner auf die mitgelieferten pvc schienen tackern oder kleben und in die zwei silber eloxierten aluminiumprofile einschieben. eLgrande ist schnell auf- und wieder abgebaut, banner lassen sich leicht und schnell austauschen. mit der teleskopstange sind sie hinsichtlich der bannnerlänge flexibel und das banner ist optimal gespannt. die stabile stofftasche für transport und lagerung liefern wir gleich mit.

**EN** eLgrande the L-banner display is convenient to handle and easy to carry. just staple or glue the banner to the pvc rails provided and insert them into the silver anodized aluminium extrusions. eLgrande is set up in no time at all and quickly stowed away after use. banners are exchanged easily, the telescopic bar allows flexibility of banner length and stretches the banner tight. the solid shoulder bag for transport and storage is included. .



## eLgrande

1	EL85220	L-banner display with bag, 1pc
2	DEXT02	connector extend, 2pcs

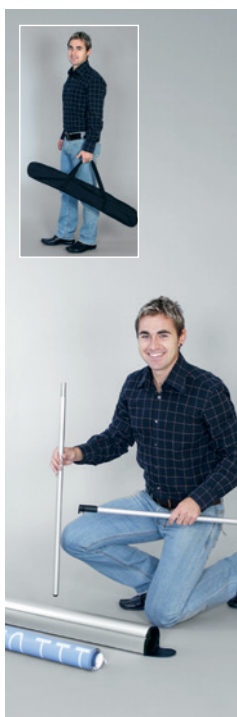

banner not included

1 eleg

montaggio semplice e non complicato: agganciare il banner sul profilo pvc incluso

*leichte, unkomplizierte montage: banner auf das mitgelieferte pvc-profil heften*

**easy and hassle-free mounting: tack the banner on the pvc-rail provided**



inserire il banner nei profili d'alluminio

*banner in die aluminium profile schieben.*

**insert banner into the aluminium extrusions**



il piedino d'appoggio, in cui inserire l'asta telescopica, è pieghevole

*der halter für teleskopauszug wird einfach ausgeklappt*

**holder for telescopic bar is folded out easily**



design intelligente: la base di appoggio funge anche da contenitore per asta telescopica e banner stampato.

*cleveres design: im standfuss werden banner und teleskopstange sicher verstaut.*

**smart design: the banner and the telescopic bar get stowed away safely in the base.**



eleg

MADE IN CHINA quality control by KD

**IT** eleg presenta ed espone in modo elegante le vostre stampe digitali, grazie all'asta telescopica con cui regolare l'altezza. quando l'espositore è smontato il banner e l'asta telescopica si ripongono nella base inferiore di sostegno. eleg è pronto per l'utilizzo in un batter d'occhio e si differenzia dagli espositori simili che si trovano in commercio grazie alla sua flessibilità: basta infatti infilare il banner nella base inferiore, inserirlo nel profilo superiore, tensionarlo e il gioco è fatto. la base di appoggio e l'asta telescopica sono in alluminio anodizzato. una robusta sacca per il trasporto è inclusa nella confezione.

**DE** eleg präsentiert ihre digitaldrucke dank des stufenlos verstellbaren teleskopstativs mit variabler länge. ihr banner und der teleskopauszug finden im standfuss platz. mit wenigen handgriffen aufgestellt, können sie bei eleg, im gegensatz zu anderen rollbannern, die banner jederzeit ganz unkompliziert wechseln: banner einfach einschieben, einhängen, spannen, fertig. standfuss und auszug sind aus eloxiertem aluminium. für den transport liefern wir ihnen die stabile tragetasche gleich mit.

**EN** eleg is the elegant display for your digital prints and thanks to its continuously adjustable telescopic bar you can use it for banners with variable lengths. during transport your digital print and the telescopic bar are stored inside the base. hassle-free mounting, unlike other rollbanners, changing the banner is effortless: just insert the banner in base and upper rail, then put up the telescopic bar. base and telescopic bar are made of silver anodized aluminium. the transport bag is included.



eleg

1 ELEG 95

banner display with bag, 1pc





banner not included



### information

roll up espositore per banner in alluminio anodizzato, pezzi di plastica in color grigio chiaro, con asta telescopica, sacca per il trasporto inclusa

roll up display für banner, eloxiertes aluminium, lichtgraue kunststoffteile, teleskopstange, inkl. transporttasche

roll up display for banner, silver anodized aluminium, light grey plastic parts, telescopic bar, transport bag incl.



# roll

MADE IN CHINA quality control by KD

**IT** il classico roll up con riavvolgimento automatico del banner nella base è facile da montare e smontare. l'asta telescopica vi permette di regolare l'altezza del display a piacere. l'aspetto accattivante e l'alta qualità dei materiali utilizzati caratterizzano roll. ideale soprattutto per eventi di lunga durata, il banner si incolla alla base con del biadesivo. la sacca per il trasporto e lo stoccaggio dell'espositore è inclusa nella confezione.

**DE** das klassische roll up display mit federmechanismus für selbsteinzug des banners in der basis. durch den einzug schnell auf- und abgebaut. die teleskopstange erlaubt variable bannerlängen. ansprechende optik und hochwertige materialien zeichnen roll aus. bannermontage mit doppelkleber und damit gut für langfristige kampagnen geeignet. mit dem display erhalten sie eine robuste tasche für mobilen einsatz und aufbewahrung.

**EN** the classic roll up display with spring mechanism for automatic recoil into the base. quickly set up. the telescopic bars allows flexibility with banner height. stylish looks and high-grade material distinguish the roll display. the mounting of the banner is effected with double sided adhesive tape. best employed for long-term campaigns. together with the display we provide you with a robust bag for transport and storage.



montaggio del banner con biadesivo; tirare il banner e tensionarlo regolando l'asta telescopica

montage des banners mit doppelkleber, herausziehen und mit teleskopstange spannen

mount the banner with double sided adhesive tape, pull out the banner and tighten with the telescopic bar



### roll

1 ROLL850

roll up banner display with bag, 1pc



espositore pieghevole a X per stampe digitali, aste laccate in nero, piedini di appoggio cromati, meccanismo in materiale plastico con chiusura di sicurezza, borsa per il trasporto.

*faltbarer X-bannerpräsentier, schwarz lackiert, enden verchromt, mechanismus kunststoff mit arretierung, inkl. transporttasche.*

**foldable X-banner display black coated, end pieces chrome plated, mechanism with locking made of plastic, incl. transport bag.**

### information

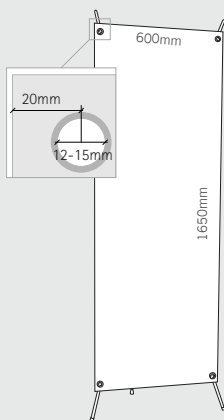

# x-image

 MADE IN CHINA quality control by KD

**IT** x-image display per banner è ideale per un uso veloce e mobile, a seconda delle occasioni. l'espositore si apre e si monta in un batter d'occhio e altrettanto velocemente il telo si fissa sui 4 ganci anteriori all'estremità di ogni asta. i bracci di sostegno e quello centrale di appoggio non si incastrano tra loro perché convergono verso il meccanismo centrale. l'asta di appoggio è regolabile in altezza, così siete voi a stabilire la giusta inclinazione e visione delle vostre stampe. la borsa per il trasporto è inclusa, così x-image è sempre pronto per fiere, promozioni, stand espositivi, convegni e qualsiasi tipo di manifestazione.

**DE** x-image bannerdisplay für den mobilen einsatz. mit wenigen handgriffen aufgestellt, gewünschtes banner einhängen, fertig. kein verheddern, da die posterstreben am mechanismus zusammenlaufen. das standbein ist höhenverstellbar, so können sie den neigungswinkel des banners wie gewünscht einstellen. die transporttasche liefern wir gleich mit, so bringen sie ihren x-image ganz leicht zu verkaufaktionen, messen, produktpräsentationen sowie veranstaltungen und events aller art.

**EN** x-image banner display is perfect for the short-time and mobile use. set up the x-image in no time, attach the banner and you are ready. no tangling up as the banner bars are already assembled with the mechanism. the main pillar can be adjusted for height and inclination of the banner as required. we provide you with the transport bag to travel with your x-image easily to sales promotions, fairs and events of all kinds.



## x-image

1 XIMAGE x banner display small with bag, 1pc





# ima2go bow

MADE IN CHINA quality control by KD

**IT** ima2go, il muro pieghevole veloce e facile da montare in qualsiasi luogo, con sistema a griglie incrociate. fissare le strisce magnetiche autoadesive al banner, posizionare il banner sulla struttura ed è fatto. un handling semplice con un effetto grandioso, subito smontato, ideale per l'uso mobile nelle fiere, eventi, manifestazioni ed altre attività.

**DE** ima2go ist die überall einsetzbare faltwand, schnell und einfach in der montage mit gebogenem scherengittersystem. selbstklebende magnetstreifen am banner befestigen, banner auf die struktur legen, fertig. einfaches handling mit grandioser wirkung.

**EN** ima2go is the all purpose popup display. fix the selfadhesive magnetic stripes to the banner, then simply lay the banner on the structure and that's it. simple handling with great effect, easy and quick set-up, perfect for mobile use at fairs, events, presentations and promotions of all kinds.

1  
ima2go

banner not included



pop-up curvo pieghevole, compreso trolley da trasporto

*faltbares pop-up, gebogen mit transportrolley*

**foldable curved pop-up, with transport trolley**

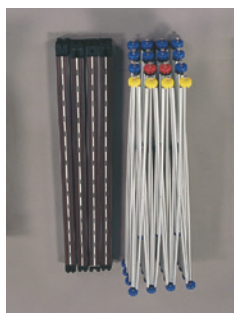

2

faretto alogeno nero, orientabile e inclinabile, 150 W

*schwarze halogen-stableuchte. schwenk- und drehbarer kopf, 150W.*

**150W halogen spot lights, in black, adjustable and directional**



3

pezzo di ricambio: biadesivo magnetico per il montaggio del banner

*ersatzteil: magnetrolle mit doppelkleber zur bannermontage*

**spare part: magnetic double adhesive tape for banner mounting**

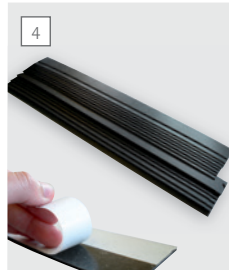

4

pezzo di ricambio: strisce magnetiche biadesive per il montaggio del banner

*ersatzteil: magnetische montagegestrips mit doppelkleber für die bannermontage*

**spare part: magnetic double adhesive hanging kits for banner mounting**

## information

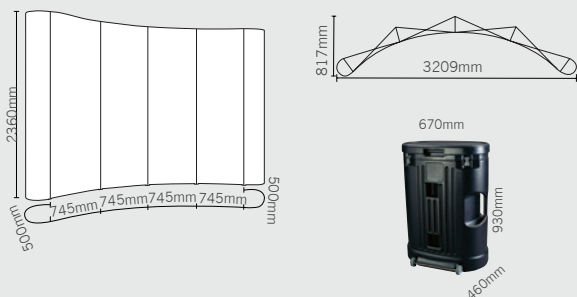

## ima2go bow



1	DIM4x3	image2go bow, 1pc	
2	DIMLP	lamp, 1pc	
3	DIM4X3ACAL	magnetic roll, 1pc	
4	DIM4X3HK	hanging kits, 1set	



1  
ima2go straight

banner not included

# ima2go straight

MADE IN CHINA quality control by KD

**IT** il pop up diritto ima2go non è solo adatto per applicazioni standard, ma è particolarmente adatto quando si ha bisogno di vere e proprie pareti divisorie, anche bifacciali, grazie alla propria conformazione. grazie al sistema rapido con velcro per il fissaggio del banner e alla borsa per il trasporto siete sempre pronti e preparati per le vostre presentazioni. i faretto alogeni inoltre garantiranno sempre la migliore visibilità per le vostre immagini.

**DE** das gerade pop up ima2go straight empfiehlt sich neben den üblichen ein-sätzen in der präsentation v.a. auch als trennwand. mit mehreren pop ups lassen sich wände bauen, auch beidseitig mit rückseitiger ergänzung. mit klettverschluss für banner und transporttasche sind sie immer schnell im einsatz. zusätzlich können sie mit der passenden halogenlampe ihr motiv stets perfekt ausleuchten.

**EN** the straight pop up ima2go is not only perfect for the usual pop up applica-tion but is recommended especially as a partition wall. with more of them you can built walls, also double-sided. with the velcro for banner mounting and the transport bag you are always prepared for your presentation. additionally you can equippe your ima2go straight with our halogen lamps and light up your image always best.



pop-up diritto e pieghevole, borsa per il trasporto inclusa

accessorio di ricambio: velcro per il fissaggio del banner

faretto alogeno nero, orientabile e inclinabile, 150 W

*faltbares pop-up, gerade mit transporttasche*

*ersatzteil: klettverschluss zur bannermontage*

*schwarze halogen-stableuchte. schwenk- und drehbarer kopf, 150W.*

**foldable straight pop-up, with transport bag**

**spare part: velcro for banner mounting**

**150W halogen spot lights, in black, adjustable and directional**

## information

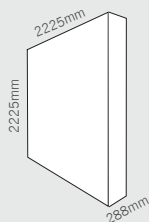

banner size:  
2225mmx2801mm  
(height x width)

## ima2go straight



1	DIMSTR3X3	image2go straight, 1pc
2	DIMVELCRO	spare part hook and loop, 1 roll
3	DIMLP	lamp, 1pc



# ima2go tower

 MADE IN CHINA quality control by KD

**IT** il favoloso pop-up tower che farà da vera colonna alla vostra presentazione. estraendola dalla sua pratica custodia, l'ima2go tower si dispiega trasformandosi in colonna che supera l'altezza d'uomo. il banner viene rapidamente fissato mediante calamita.

**DE** ima2go der tolle pop - up tower - eine echte säule ihrer präsentation. aus der praktischen tragetasche entfaltet sich der ima2go tower im handumdrehen zu einer übermannshohen säule. das banner wird mit magnet schnell und einfach montiert.

**EN** ima2go is a great pop-up tower - a real pillar of your presentation. taken out of the convenient transport bag the ima2go tower sets up in no time at all into a high column. banner mounting is quick and easy thanks to the magnetic strips.



per ricambio: biadesivo magnetico  
ersatzteil: magnetrolle doppelkleber  
spare part: magnetic adhesive tape

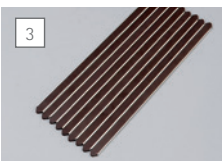

ricambio: strisce magnetiche adesive per il montaggio del banner  
ersatzteil: magnetische montagestrips mit doppelkleber  
spare part: magnetic double adhesive hanging kits

## information



## ima2go tower



1	DIMTOW	imag2go tower, 1pc
2	DIMTOWACAL	magnetic roll, 1pc
3	DIMTOWHK	hanging kits and magnets, 1set



1  
standbyU

print not included

standbyU



1 DSTBU

standbyU, 1 pc

# standbyU

MADE IN CHINA quality control by KD

**IT** standbyU il counter promozionale per utilizzo mobile: personalizzabile facilmente con stampe, robusto e stabile, mobile e pratico.

**DE** standbyU der promo-counter für den mobilen einsatz: einfach mit druck zu personalisieren, robust und stabil, mobil und praktisch.

**EN** standbyU the promotional counter for mobile use: easily personalisable with print, robust and stable, mobile and practical.



## information

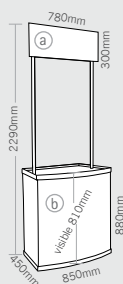

promo-counter mobile e personalizzabile con stampa, sacca compresa

promo-counter für den mobilen einsatz und personalisierbar mit druck, incl. transporttasche

mobile counter for promotion, customizable with print, transport bag incl.



bannersize (a) : 300mmx780mm (height x width)  
bannersize (b) : 880mmx197mm (height x width)

pratica zona di stoccaggio nel counter c'è molto spazio per depositare cataloghi, oggetti promozionali o altro materiale.

praktischer stauraum: im counter findet sich viel platz für kataloge, werbegegenstände oder anderes aktionsmaterial.

practical storage area: on the counter there is ample space to place catalogues, promotional material and other objects.

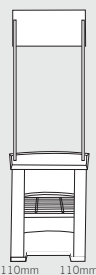





1  
pirouet vetrina

banner not included

# pirouet vetrina

MADE IN EU design by KD

**IT** pirouet vetrina è un display mobile che può fungere da vetrina e porta comunicazioni. grazie ad un semplice movimento rotatorio si monta in un batter d'occhio senza utilizzare nessun utensile e altrettanto velocemente si smonta. quando pirouet è ripiegata su se stessa occupa pochissimo spazio di stoccaggio. le pareti si montano velocemente grazie alle strisce magnetiche e altrettanto velocemente e semplicemente si possono personalizzare con stampe o vinili adesivi. le luci, incassate nella vetrina, vi consentono di avere la giusta illuminazione per la presentazione ideale dei vostri prodotti.

**DE** pirouet vetrina ist ein mobiles display, das sie als vitrine und kommunikationsträger einsetzen können. es lässt sich mit einer einfachen drehbewegung ganz ohne werkzeug im nu aufstellen und wieder raumsparend zusammenfallen. die wände sind dank der magnetverschlüsse sofort montiert und werden einfach mit druck oder durch kaschieren personalisiert. die eingebaute leuchte setzt ihre produktpräsentation ins rechte licht.

**EN** pirouet vetrina is a mobile display, that you can use as display cabinet and communication display as well. it sets up into place and folds down space-saving at once without any tools. the walls are mounted thanks to the magnetic systems in no time at all. you can customize the panels with print or laminate easily. the shelf includes a recessed light to illuminate your product presentation perfectly.



si monta con un semplice movimento, i pannelli si fissano in modo sicuro alla struttura grazie alle strisce magnetiche

mit einer bewegung aufstellen, paneele haften dank magnetverschluss sicher

sets up in one movement, panels hold safely thanks to the magnetic system

## information

la struttura pirouet include 8 pannelli bianchi e 8 trasparenti e l'illuminazione

pirouet struktur incl. 8 weißer und 8 transparenter paneele, beleuchtung

pirouet structure incl. 8 white and 8 transparent panels, lighting

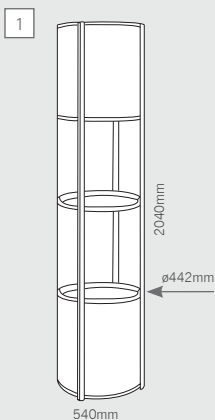

## pirouet vetrina

1 DPIR2000

pirouet vetrina, 1pc

15,4



1  
pirouet counter

# pirouet counter

MADE IN EU design by KD

**IT** pratico counter che si allestisce in una manciata di secondi e che, grazie alle pareti personalizzabili, si adatta ad ogni evento: ecco a voi pirouet counter! il tavolino top superiore è laccato in color grigio argento, nella parte posteriore c'è tantissimo spazio per mettere i vostri cataloghi, i campioni o le vostre documentazioni riservate. con la stessa velocità con cui lo avete allestito, altrettanto rapidamente pirouet counter si smonta e si richiude, facendovi risparmiare spazio e volume sia durante il trasporto che per lo stoccaggio a magazzino. in ogni caso, non avete bisogno di nessun utensile per usare pirouet counter, che si rivela un ottimo accompagnatore per eventi, saloni, fiere e roadshows.

**DE** ein praktischer counter, der sich in sekunden aufaltet und mit den personalisierbaren wänden zu jedem event passt, das ist pirouet counter. die top-platte ist silbergrau lackiert, auf der rückseite findet sich ausreichend stauraum. genauso schnell wie sie ihn aufgebaut haben, faltet sich pirouet counter wieder platzsparend für transport und lagerung zusammen. sie brauchen keinerlei werkzeug, ein idealer mobiler begleiter für events, messen und roadshows.

**EN** this is a real convenient counter, that sets up in seconds. it matches every event perfectly with the customizable wall panels. the table top is varnished silver grey, on the rear side you find enough storage space. as fast as you have set it up, the pirouet counter folds away, saving space for transport and storage. you need no tools at all, it is your perfect companion for events, fairs and road shows.



si monta facilmente, con uno spazio deposito sul retro

schnell aufgestellt, mit stauraum auf der rückseite

quickly set up, with storage space on the rear side

## information

struttura composta da 6 pannelli bianchi e tavolino top grigio argento

struktur mit 6 weissen paneelen, silbergrauem top

structure incl. 6 white panels, silver grey table top

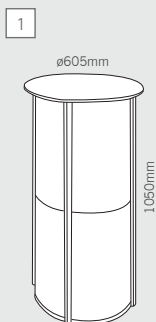

## pirouet counter

1	DPIR1000	pirouet counter, 1pc
2	DPIRBAG	bag pirouet, 1pc





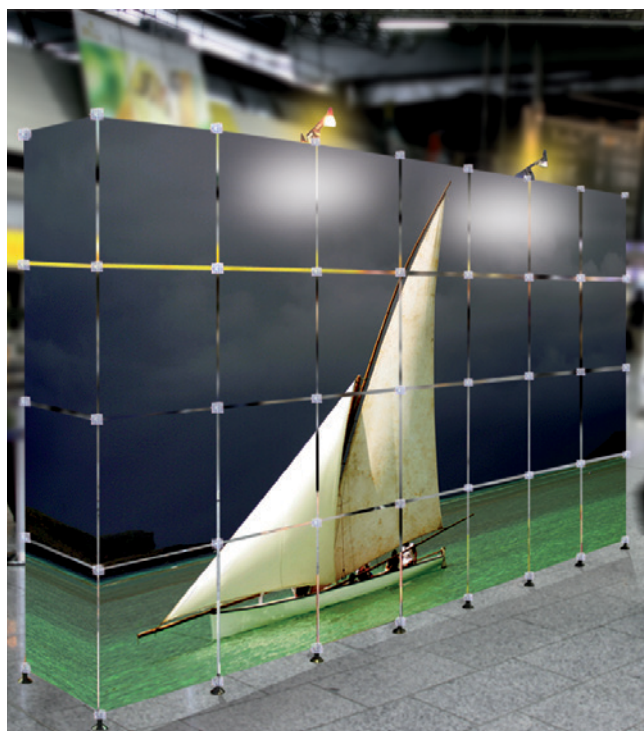

# digiplug

MADE IN CHINA quality control by KD

**IT** leggero, facile da usare, veloce da installare: ecco digiplug, il connettore ad 8 vie per pannelli con spessore di 4 mm. digiplug è particolarmente consigliato con pannelli leggeri, di piccole dimensioni e quadrati, perchè il connettore si monta sugli angoli, non in mezzo. digiplug da un lato è filettato, per consentirne l'utilizzo con tutta una serie di accessori. vi offriamo digiplug come set completo fornito in un a pratica valigetta per il trasporto o a singoli componenti.

**DE** schnell leicht und einfach: das ist digiplug 8-wege verbinder für 4mm starke paneele. besonders empfiehlt sich digiplug mit kleinformatigen, quadratischen leichtstoffplatten, da digiplug an den ecken, nicht mittig, eingesetzt wird. jeder digiplug hat an einer seite ein gewinde für die befestigung von zubehör. wir bieten ihnen digiplug als komplettsset im praktischen transportkoffer oder als einzelkomponente an.

**EN** quick, light and easy: this is digiplug, the 8-way connector for 4mm panels. especially recommended is digiplug with small sized, squared lightweight panels as the connector is used at the corners, not in the middle. every digiplug comes with a thread on one side for mounting the accessories. we offer digiplug as a complete set with handy transport case or as single components.

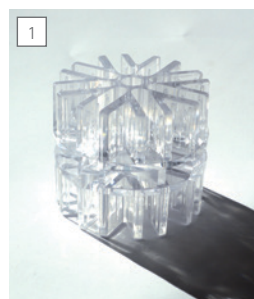

1

connettore ad 8 vie, PS trasparente, con filetto M5, per interni

*8-wege verbinder, transparentes PS, mit M5 gewinde, für innenbereich*

**8-way connector, transparent PS, with M5 thread, for indoor use**

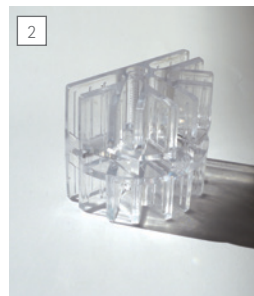

2

connettore a 5 vie, PS trasparente, con filetto M5m per interni

*5-wege verbinder, transparentes PS, mit M5 gewinde, für innenbereich*

**5-way connector, transparent PS, with M5 thread, for indoor use**



1

digiplug full



2

digiplug half



connettore per pannelli: angolatura variabile, semplicità di utilizzo

*paneelverbinding: variabel und einfach*

**panel connection: variable and easy**

## digiplug



1	DPLU8TR	digiplug full, transparent, 1pc	
2	DPLU5TR	digiplug half, transparent, 1pc	
3	DPLUREG	digiplug regulator, 1pc	
4	DPLUAVEN	digiplug suction cup, 1pc	
5	DPLULMP	digiplug lamp, 1pc	
6	DPLUAS	digi plug antislip pad 0,8mm, 20pcs	
7	DPLUFS	digiplug full set, 1pc	

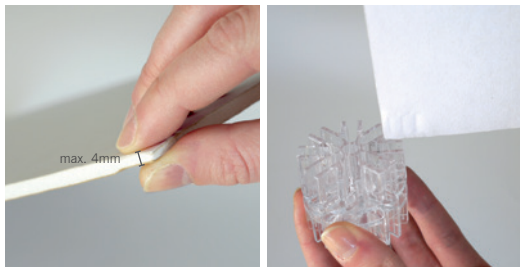
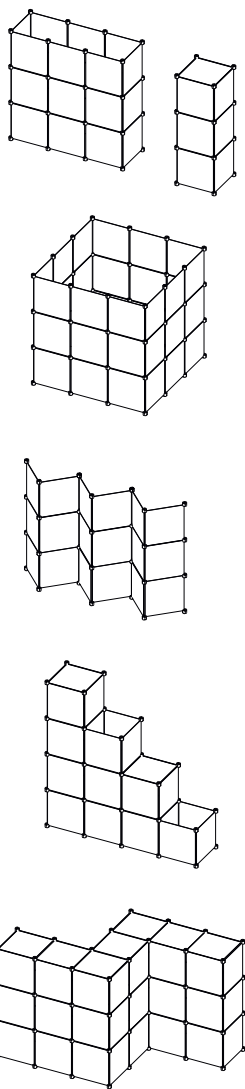

particolarmente indicato per pannelli leggeri flessibili e non troppo rigidi o per cartone di 5 mm di spessore, ma che si possano ridurre a 4 mm durante l'inserimento in digiplug.

*besonders geeignet für flexible leichtstoffplatten oder karton mit 5mm, die sich auf 4mm bei ein Schub reduzieren.*

**especially recommended for flexible lightweight panels or cardboards with 5mm that reduce to 4mm when inserted**

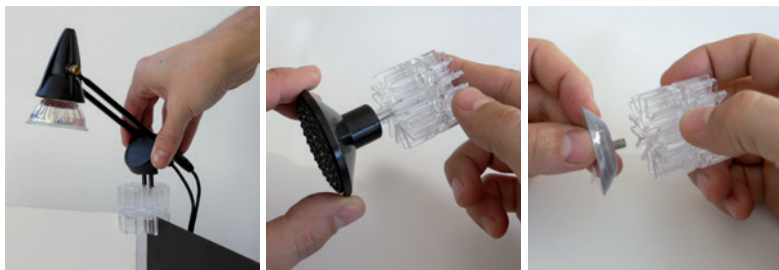

accessori: le lampade vengono fissate sui pannelli, i piedini e le ventose vengono avvitati sul filetto.

*zubehör: lampen werden aufgesteckt, standfüsse und haftsauger werden am gewinde eingeschraubt*

**accessories: lamps are simply plugged on top, feet and suction cups are screwed into the thread**



i piedini sono di materiale plastico nero

*standfüsse aus schwarzem kunststoff*

**foot made of black synthetic**

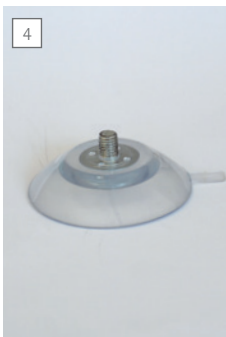

le ventose, filettate, sono ideali per il fissaggio su superfici lisce

*haftsauger mit gewinde für befestigung auf glatten oberflächen*

**suction cup with thread for mounting on smooth surfaces**



lampade alogene a 35 W per il completamento della composizione

*35W halogenstrahler zum aufstecken*

**35W halogen lamp to plug in**



biadesivo per pannelli da 3mm

*doppelkleber für 3mm paneele*

**double adhesive tape for 3mm panels**



set completo composto da 2 lampade alogene, 8 piedini, 8 ventose, 12 digiplug da 180°, 28 digiplug interi da 360°, valigetta per il trasporto.

*komplettsset mit 2 halogenleuchten, 8 standfüssen, 8 haftsauger, 12 half und 28 full digiplug, transportkoffer*

**complete set with 2 halogen lamps, 8 feet, 8 suction cups, 12 half and 28 full digiplugs, transport case**







# connector

 MADE IN TAIWAN quality control by KD

**IT** sistema modulare ad incastro per vetrine. realizzate la vostra personalissima vetrina con pannelli da 5mm e fissaggi angolari „connector“ in policarbonato color vetro. utilizzate gli esempi proposti per individuare l' elemento idoneo al vostro allestimento. i „connector“ sono venduti singolarmente, ciò vi consente di ordinare solo quello che vi serve realmente. ideale per negozi, showroom, musei, vetrine e anche per l'arredamento di casa.

**DE** schlagfeste eckverbinder aus glasgrünem polycarbonat für cuben nach dem baukasten-system. gestalten sie ihre persönliche vitrine mit connector eckhaltern und 5mm-paneelen. die beispelskizzen helfen Ihnen bei der richtigen auswahl der entsprechenden eckverbinder. eine tolle sache für shop, showroom, museum, schaufenster und homebereich.

**EN** shock-resistant panel-connector made of glassgreen polycarbonate for modular cube systems. create your personal show case with 5mm-panels and connectors. the drawings with examples help you choosing the right parts. it's a peach for shop, showrooms, museums, shop windows and at home as well.

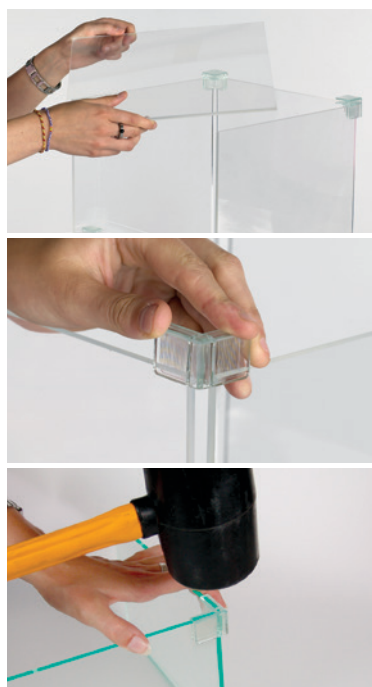

**C**  
FCONC

## information

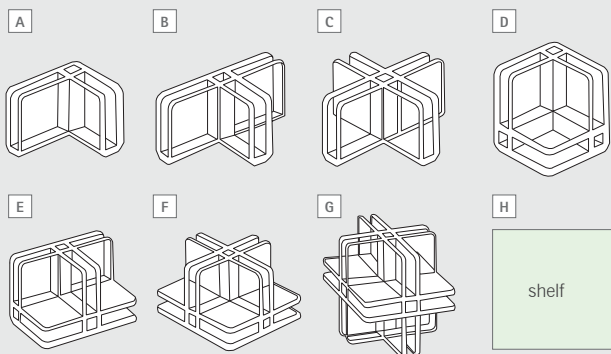

## connector



A	FCONA	1pc	
B	FCONB	1pc	
C	FCONC	1pc	
D	FCOND	1pc	
E	FCONE	1pc	
F	FCONF	1pc	
G	FCONG	1pc	
H	FCON330PL	shelf, transparent acrylic, 330x330x5mm, 1 pc	

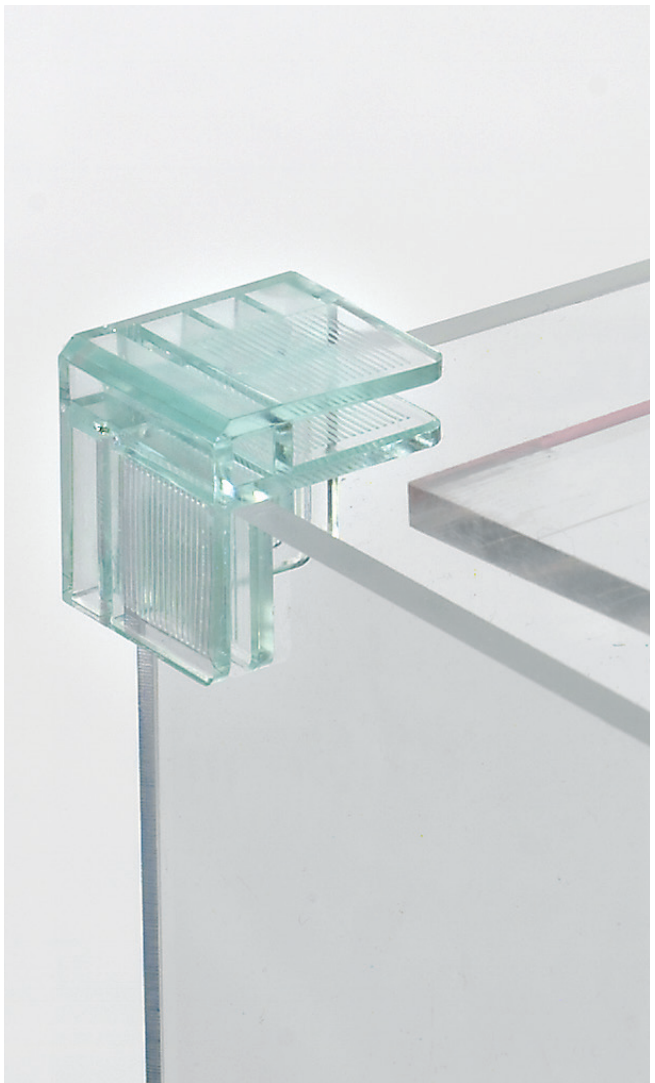
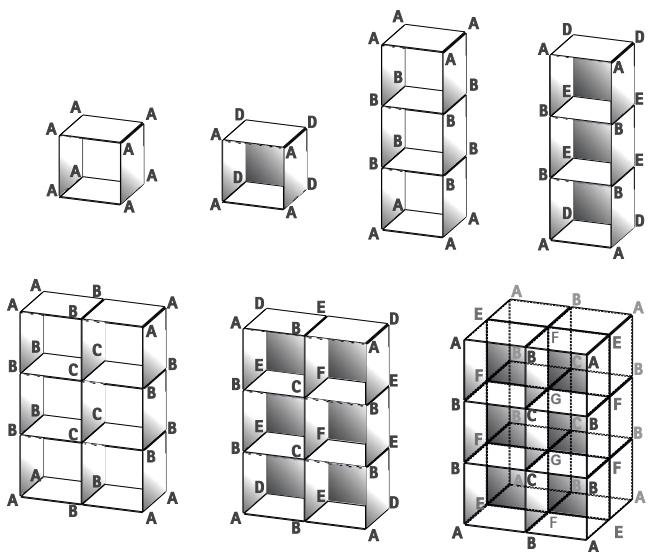



# ix bond

MADE IN EU design by KD

**IT** ixbond può connettere pannelli da 3 a 10mm con sicurezza e senza il rischio di torsioni. discreto e funzionale una volta uniti, i pannelli risulteranno a soli 6mm di distanza. la vite di chiusura è facilmente raggiungibile dal lato esterno e dal lato interno garantendo così la migliore comodità di esercizio - pratico, specialmente per strutture 3D o vicino alle pareti. ergonomici e decorativi „snodi“ per montare in convenienza. cacciavite a parte

**DE** ixbond verbindet paneel von 3-10mm stufenlos sicher und verwindungsstabil. die sichtfuge bleibt dabei immer dezent mit 6mm. die schraube kann beidseitig (innen wie aussen) eingesetzt werden - praktisch, wenn sie räumliche konstruktionen umsetzen oder nahe an wänden bauen. ergonomische und ästhetische griffmulden erleichtern die montage. gewünschte anzahl inbus-schlüssel bitte extra bestellen.

**EN** ixbond connects 3-10mm panels infinitely and free of torsion. the face joint remains at a discrete 6mm gap. the screw can be mounted from both sides. convenient if you create structures in 3-D or close to walls. ergonomic and decorative recessed grips make mounting easy. order the required keys separately.



1 60°

60° connettore: zamac color argento satinato, vite acciaio inox

60° verbinder: versilberter metall-druckguss, schraube edelstahl

60° connector: silver-plated metal die-cast, stainless steel screw

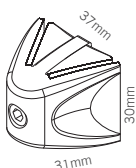

2 90°

90° connettore: zamac color argento satinato, vite acciaio inox

90° verbinder: versilberter metall-druckguss, schraube edelstahl

90° connector: silver-plated metal die-cast, stainless steel screw

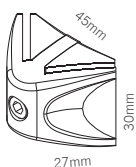

3 135°

135° connettore: zamac color argento satinato, vite acciaio inox

135° verbinder: versilberter metall-druckguss, schraube edelstahl

135° connector: silver-plated metal die-cast, stainless steel screw

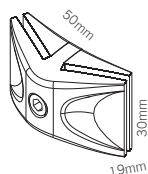

4 180°

180° connettore: zamac color argento satinato, vite acciaio inox

180° verbinder: versilberter metall-druckguss, schraube edelstahl

180° connector: silver-plated metal die-cast, stainless steel screw

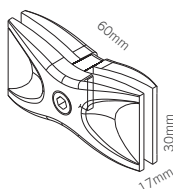

5

in zamac color argento per fissare pannelli a „sandwich“.

versilberter metall-druckguss für die sicherung von sandwich systemen.

silver-plated metal die-cast for locking sandwich systems.

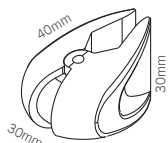

## information

180°

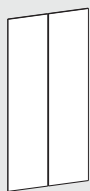

135°

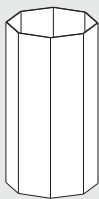

90°

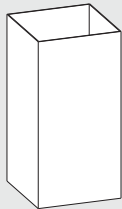

60°

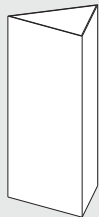



panel not included

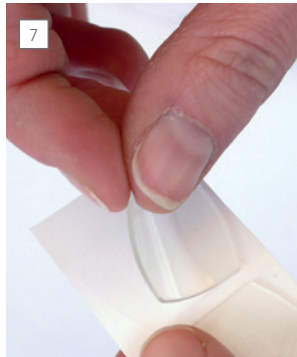
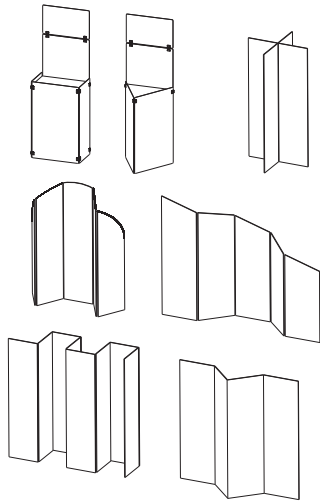

ix bond feltrino (spessore 1mm) per il montaggio di materiale delicato o vetro. spessore pannello: 2mm-8mm.

*ix bond buffer (1mm dick) für die befestigung von empfindlichen materialien oder glas. paneelstärke mit buffer: 2mm-8mm.*

**ix bond buffer (1 mm thick) for the mounting of sensitive materials or glass. panel thickness with buffer: 2mm-8mm.**

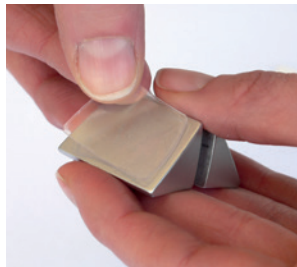

chiave esagonale 4mm  
inbusschlüssel 4mm  
key 4mm hex ballpoint L-handle

ixbond



1	IX2B60AR	60° connector, 1pc
2	IX2B90AR	90° connector, 1pc
3	IX2B120AR	135° connector, 1pc
4	IX2B180AR	180° connector, 1pc
5	IX2BSWAR	ixbond sandwich connector, 1pc
6	SOKEY4	t-handle hex key, 1pc
7	ATPXB	ix bond buffer, box/20pcs





# digipressto

 MADE IN EU design by KD

**IT** digipressto è straordinario: grazie a lui i vostri pannelli potranno diventare indicatori di direzione, banner pubblicitari, divisori di spazio o elementi decorativi per interni ed esterni. utilizzate a piacere la base in alluminio con pannelli di 30 mm: grazie alla sua speciale conformazione, pannelli di qualsiasi materiale rimangono stabili e diritti sulla base. digipressto si apre e si chiude grazie ad una vite a testa zigrinata che tiene uniti i 2 profili. i feltrini compresi nella confezione proteggono il pannello e rendono la base anti-scivolo e più stabile. nella versione in alluminio anodizzato color argento digipressto è disponibile già montato nei formati più comuni. il programma di accessori comprende tappi laterali in colore nero e 2 versioni laccate in nero rispettivamente di 100mm e 200mm (con tappi laterali neri).

**DE** eine tolle sache: mit ihrem panel wird digipressto zum hinweisschild, werbebanner, raumteiler oder dekorativem element im innen- und aussenbereich. kombinieren sie das aluminiumprofil mit paneelen der stärke von 30mm. unterschiedlichste materialien werden gleichmässig eingespannt. geöffnet und geschlossen wird digipressto mittels rändelschraube. integrierte gummilitzen schützen ihr panel und geben rutschfesten stand. in silber eloxierter ausführung sind die gängigsten längen vormontiert. im zubehör programm finden sie schwarze seitenabdeckkappen. ausserdem im programm: 100mm bzw. 200mm mit schwarzer pulverbeschichtung und abdeckkappen.

**EN** digipressto is really great: together with your panel digipressto becomes a signpost, an advertising banner, a partition wall or a decorative element in interior and exterior areas. combine the anodized aluminium profile with panel from 30mm. the special construction gives digipressto maximum flexibility: materials are shut in safely by digipressto. open and close the profile easily with the knurled head screw. integrated rubber laces protect your panel and act as anti-slip pads as well. the most standard lengths come already mounted. black side caps can be ordered as an accessory. furthermore we provide you with 100mm and 200mm lengths black powder coated and with side caps.

panel not included



1-4

profilo in alluminio anodizzato con protezione anti-scivolo, vite a testa zigrinata

*klemmprofil aus eloxiertem aluminium, mit anti-rutsch schutz und rändelschraube*

**clamping profile made of anodized aluminium with anti-slip protection and knurled head screw**



5

tappi laterali abs nero, set con 4 pz  
*seitenabdeckkappen abs schwarz, set mit 4 stück*

**lateral cover caps abs black, set with 4 pcs**



**personalizzabile  
personalisierbar  
customizable**

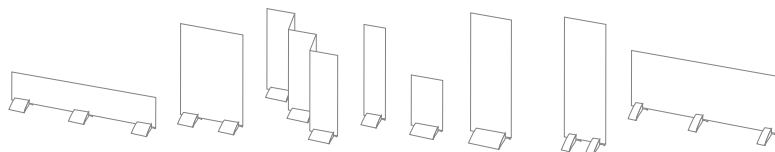



panel not included

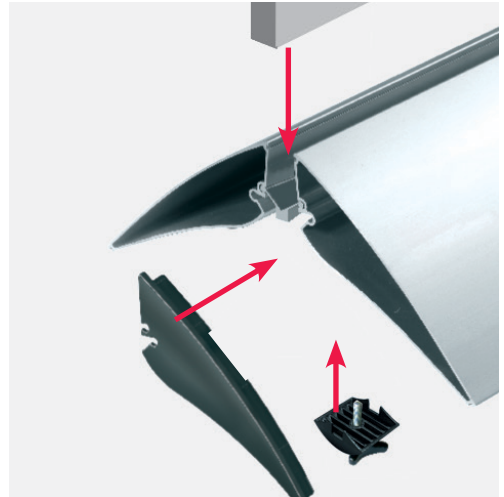

8 in zamac color argento per fissare pannelli a „sandwich“. cacciaviti a parte.  
 versilberter metalldruckguss für die sicherung von sandwich systemen. inbus-schlüssel bitte extra bestellen.  
 silver-plated metal die-cast for locking sandwich systems. order the required keys separately.

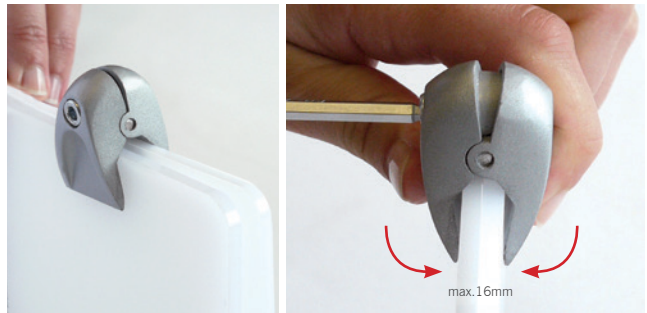
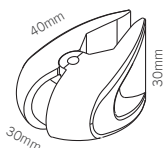

digipresto



1	PT235	digipresto silver 235mm, 1pc	
2	PT300	digipresto silver 300mm, 1pc	
3	PT400	digipresto silver 400mm, 1pc	
4	PT500	digipresto silver 500mm, 1pc	
5	PTAKSZ	cover caps black, 4pcs	
6	PT100SZ	digipresto black 100mm, 1pc	
7	PT200SZ	digipresto black 200mm, 1pc	
8	IX2BSWAR	ixbond sandwich connector, 1pc	
9	SOKEY4	t-handle hex key, 1pc	

information

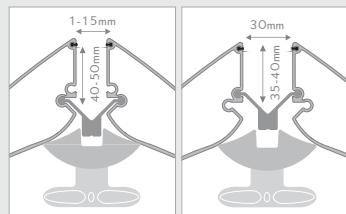

l'altezza massima del pannello varia a seconda del materiale utilizzato e del suo spessore. ogni applicazione deve essere verificata prima della installazione.

maximale paneel-höhe und -breite sind vom verwendeten plattenmaterial abhängig. jede anwendung ist daher individuell auf eignung zu prüfen.

maximum panel height and width depend on the used material. every application has to be approved individually if appropriate.



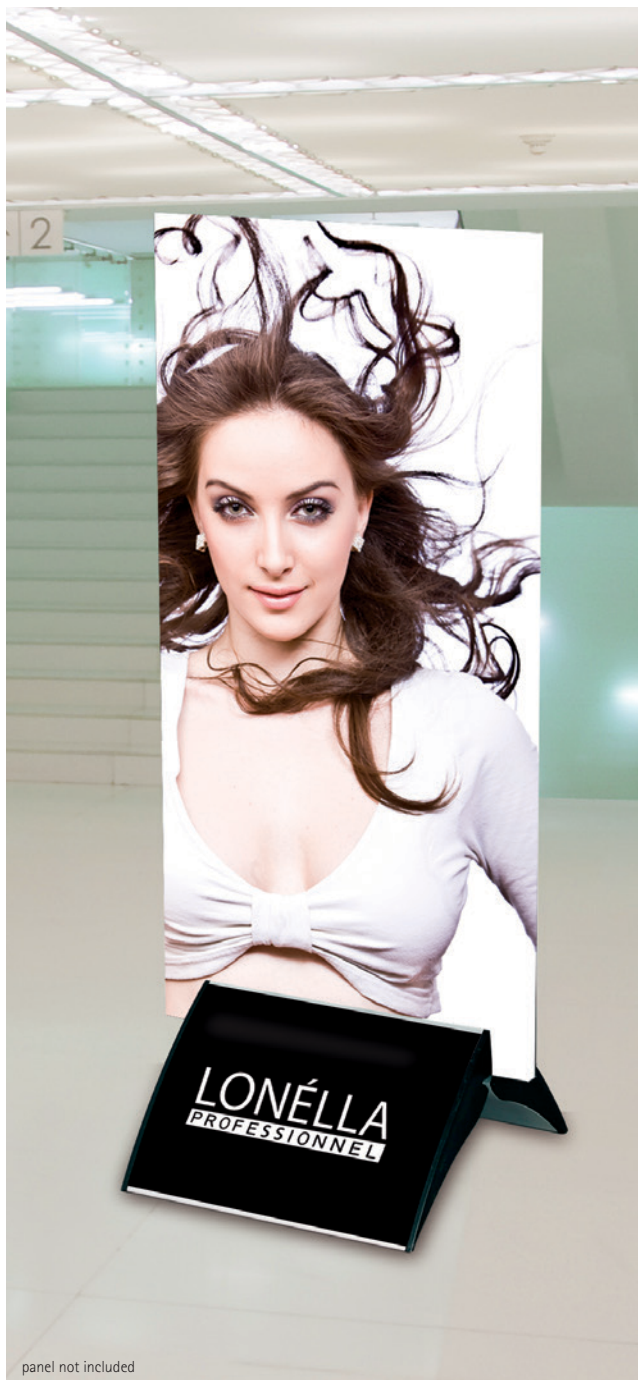
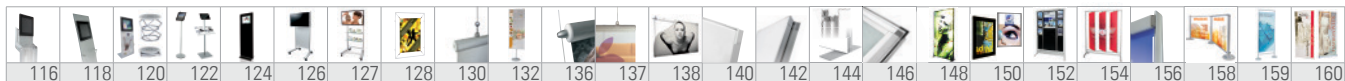

# mypressto

MADE IN EU design by KD

**IT** mypressto vi offre tutti i vantaggi del sistema digipressto ed in più la possibilità esclusiva di personalizzare la superficie con una grafica adatta all' evento, il corporate aziendale o perfino per renderlo adatto al tipo di arredo circostante. basta la stampa con o senza il foglio protettivo. non solo a immagini, quindi, o marchi aziendali, ma design a colori o per riprendere ornamenti alle pareti o sul pavimento. i tappi laterali in colore nero rifiniscono e completano il vostro mypressto.

**DE** mypressto bietet neben den bewährten digipressto-klemmprofil vorteilen auch noch die einzigartige möglichkeit der persönlichen gestaltung passend zum event, zum corporate oder sogar zur inneneinrichtung. einfach den passenden druck mit oder ohne coverfolie einschieben. denken sie dabei nicht nur an bilder oder firmenlogos: farbige gestaltung oder boden- bzw. wanddekore aufzunehmen hat immer eine ganz besondere wirkung. die abdeckkappen in elegantem schwarz runden das gesamtbild ab.

**EN** besides all the approved advantages of the digipressto system, mypressto can be customized to match your event, the company corporate or even the interior decoration. simply insert the matching print with or without cover. think different: not only images or logos - colourful designs or copying the floor or wall decoration has a very special effect. elegant black caps complete the overall look.

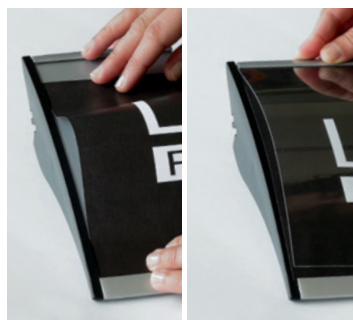

in alluminio anodizzato color argento satinato, tappi laterali colore nero, foglio protettivo trasparente

silber eloxiertes aluminium, schwarze abdeckkappen, transparente cover-folie

silver anodized aluminium, black caps, transparent cover

panel not included

## information

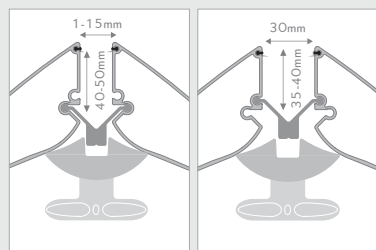

## mypressto



1	MYPTA4	mypressto, A4, 1pc	
2	MYPT400	mypressto, 210x400mm, 1pc	
3	MYPT500	mypressto, 210x500mm, 1pc	
4	IX2BSWAR	ixbond sandwich connector, 1pc	
5	SOKEY4	t-handle hex key, 1pc	



2  
myspresso 210x400mm



in zamac color argento per fissare pannelli a „sandwich“. cacciaviti a parte.

versilberter metalldruckguss für die sicherung von sandwich systemen. inbus-schlüssel bitte extra bestellen.

silver-plated metal die-cast for locking sandwich systems. order the required keys separately.

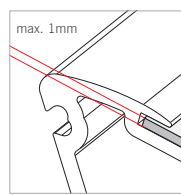
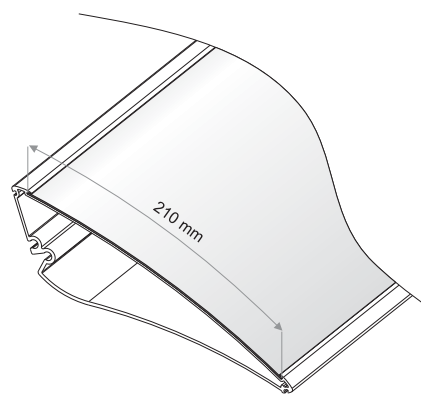
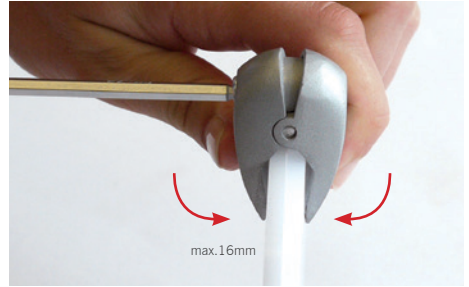
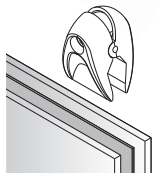

con foglio protettivo da 1mm per materiale fino ad 1mm di spessore.

mit cover-folie (1mm) können sie max. 1mm starkes material verwenden.

with cover (1mm) you can use max. 1mm thick material.

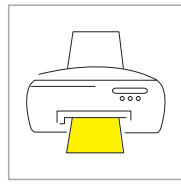

personalizzazione semplice ed immediata direttamente con il tuo pc e stampante!

beliebiges motiv am pc gestalten, ausdrucken, fertig!

design your image with pc, print and here you go!

panel not included



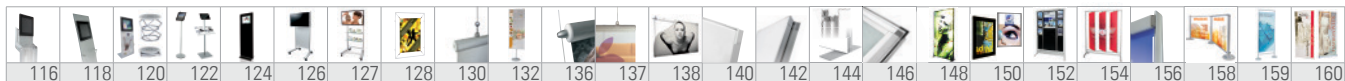

1  
pylo 1905x400mm

print not included

# pylo

MADE IN EU design by KD

**IT** totem pylo: base metallica verniciata a polvere color argento e profili in alluminio anodizzato argento; i pannelli portainformazioni offrono una comoda e versatile superficie per stampe dirette, scrivibili o a plotter; il pylo é disponibile in tre differenti larghezze, ideale come sistema autoportante oppure abbinato agli elementi modulari del sistema soistes. i fori nella base permettono, se necessario, un sicuro ancoraggio al suolo.

**DE** totem pylo: silber pulverlackbeschichtete metallbasis, silber eloxierte aluminium-profile und -paneel zum bedrucken, bekleben und beschriften. erhältlich in drei verschiedenen breiten. optimal als freistehendes display oder in kombination mit dem modularen einrichtungssystem soistes. mit den lochbohrungen in der basis kann pylon bei bedarf sicher im boden verankert werden.

**EN** totem pylo: silver powder coated metal base, silver anodized aluminium extrusions and panels for print or laminate. available in three different widths. perfect as a freestanding display as well as in combination with our modular display system soistes. thanks to the holes in the base the pylo can be safely anchored in the ground if necessary.



2  
pylo 1905x600mm

## information

alluminio anodizzato color argento, base verniciata a polvere color argento.

*silber eloxiertes aluminium, silber pulverbeschichtete metallbasis.*

silver anodized aluminium, powder coated metal base.

- 1 400mm
- 2 600mm
- 3 800mm

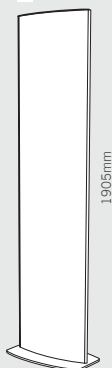

other possible combinations!

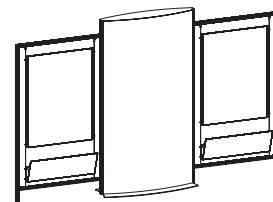

pylo

1	SOPY1900400	pylo 1905x400mm , 1pc
2	SOPY1900600	pylo1905x600mm, 1pc
3	SOPY1900800	pylo 1905x800mm, 1pc



3  
pylo poster 1000x700mm

print not included

# pylo poster

MADE IN EU design by KD

**IT** pylo poster è il totem autoportante per la presentazione di informazioni facilmente sostituibili grazie alle tasche portaposter disponibili in tre diverse misure e munite di protezione trasparente flessibile in policarbonato resistente ai raggi ultravioletti.

**DE** freistehendes totem pylo poster für flexible informationpräsentation: mit beidseitigen postertaschen erhältlich für drei gängige plakatgrößen. ausführung wie pylo mit flexibler coverfolie aus uv-beständigem polycarbonat.

**EN** freestanding totem pylo poster for flexible information presentations: with poster pockets on both sides in the most common poster sizes. design and materials like pylo plus a flexible cover sheet made of uv-resistant polycarbonate.



facile e rapida apertura della custodia protettiva grazie al suo razionale design

*schnelles und unkompliziertes öffnen und schliessen der cover folie dank cleverem design*

**quick and easy opening and closing of the cover sheet thanks to our clever design.**

## information

profilo in alluminio anodizzato color argento, pannello in alluminio argentato con pellicola di policarbonato resistente ai raggi UV, base metallica verniciata color argento.

*silber eloxiertes aluminium profil, silber aluminium verbund panel, uv-beständige PC folie, silber lackierte metallbasis.*

silver anodized aluminium extrusion, silver aluminium composite panel, uv-resistant pc cover, silver coated metal base.

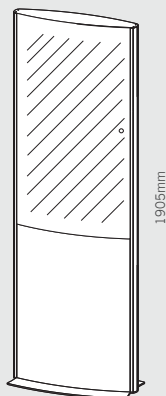

	poster	visible
1	700x500mm	700x474mm
2	841x594mm	841x568mm
3	1000x700mm	1000x674mm

integrate your pylo to soistes structure!

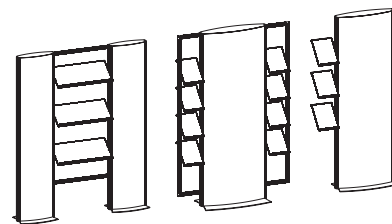

## pylo poster

1	SO19PP700500	pylo poster 700x500mm, 1pc
2	SO19PPA1	pylo poster A1, 1pc
3	SO19PP1000700	pylo poster 1000x700mm, 1pc



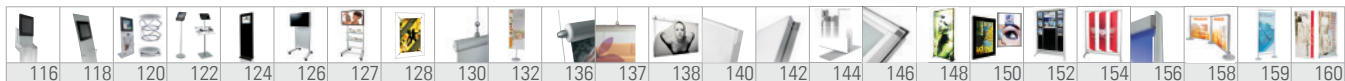

1  
ipoint 1900x400

print not included

# ipoint

MADE IN EU design by KD

**IT** ipoint é il pratico totem fornito completo di due pannelli in alu bond colore argento e bianco opaco per la stampa digitale, che vi permetterà di creare la vostra grafica sia sul fronte che sul retro. dopo aver effettuato la personalizzazione, incollate i pannelli direttamente ai profili con del silicone o con un'altra colla adatta per quel tipo di materiale. inoltre, a scelta si possono aggiungere ripiani, barre laterali, accessori o altri moduli ipoint dalla linea soistes. chiedeteci e noi saremo sempre a disposizione per darvi ulteriori idee ed informazioni.

**DE** ipoint liefern wir ihnen mit zwei doppelseitigem alu-verbundpaneel: silber und weiss matt für digitaldruck. sie können so selbst entscheiden wie sie jeweils die vorder- und auch die rückwand ihres ipoint gestalten. nach der personalisierung verkleben sie den ipoint mit silikon oder anderem geeigneten klebstoff direkt am profilrahmen. optional lassen sich ablagen, display bars oder weitere ipoint flächen ergänzen. fragen sie uns, wir beraten sie gerne.

**EN** ipoint comes complete with two double side aluminium composite panels: satin silver and matt white for digital printing. thus you can freely design front and rear side of your ipoint. after customizing the panels can be simply fixed with silicone or other glue to the profile frame. optionally you can add trays, display bars or further ipoint modules. just ask us, it is our pleasure to provide you with more ideas and further information.



5

connettore per strutture ipoint in zamac color argento.

*verbinder für ipoint strukturen, versilberter metall druckguss.*

**connector for ipoint structures, silver plated die-cast metal.**

## information

profili in alluminio anodizzato color argento, base metallica verniciata a polvere color argento, pannelli di alluminio composito color bianco opaco e argento, angoli in zamac color argento.

*silber elox-aluminium profil, basis metall silber pulverbeschichtet, alu-verbundpaneel mattweiss/silber, eckverbinder versilberter metall-druckguss.*

**silver anodized aluminium extrusion, base silver coated metal, aluminium composite panel matt white/silver, edge connectors silver-plated die-cast metal.**

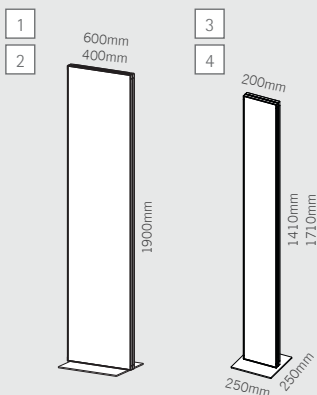

other possible combinations!

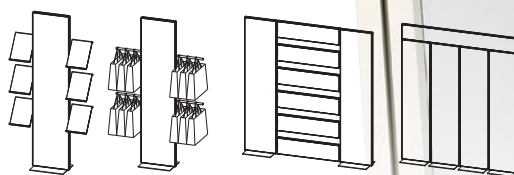

ulteriori informazioni pag. 338  
mehr details s. 338  
more information p. 338

338

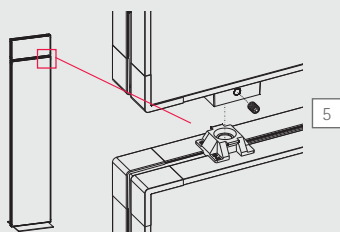

## ipoint

1	IP1900400ARW	ipoint 1900x400 silver/white, 1pc	
2	IP1900600ARW	ipoint 1900x600 silver/white, 1pc	
3	IP1400200ARW	ipoint 1410x200 silver/white, 1pc	
4	IP1700200ARW	ipoint 1710x200 silver/white, 1pc	
5	IPTCON	ipoint connector, set 2pcs	



2  
pylo 1900x600mm

print not included

# pylo outdoor

MADE IN EU design by KD

**IT** pylo outdoor è concepito e realizzato appositamente per l'esterno: a seconda della collocazione, la struttura può essere interrata, ancorata o cementata al suolo. i pannelli in alluminio possono essere stampati o decorati con pellicole, prespaziati, vinili, ecc. i pannelli, così come i profili in alluminio anodizzato e gli angoli stampati a pressofusione, sono di alta qualità e duraturi nel tempo. pylo outdoor è disponibile in tre differenti larghezze.

**DE** pylo outdoor ist speziell für den aussenbereich gemacht: die bodenhalterung wird je nach untergrund angeschraubt oder einzementiert. die aluminium-paneele können sie je nach anforderung bedrucken oder kaschieren. sie sind wie die ebenfalls silber eloxierten aluminiumprofile sowie die veredelten metalldruckguss-ecken hochwertig und langlebig. erhältlich ist der pylo outdoor in drei verschiedenen breiten.

**EN** pylo outdoor is made especially for outdoor use: the ground sleeve can be fixed with screws or concrete according to your underground. the silver anodized aluminium panels can be printed or laminated. like the silver anodized profiles and the plated zinc aluminium alloy die-cast connectors they are robust and durable. the pylo outdoor is available in three different sizes.



## information

profili e pannelli: alluminio anodizzato color argento, angoli in pressofusione, zanche da terra in ferro zincato.

profile und paneele: silber eloxiertes aluminium, verbinder veredelter aluminiumdruckguss, bodenhülse eisen verzinkt

panel and profiles: silver anodized aluminium, connectors plated die cast aluminium alloy, ground sleeve zincated iron

- 1 400mm
- 2 600mm
- 3 800mm

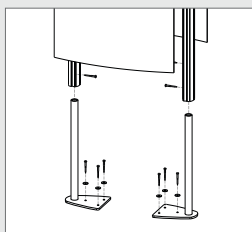

## pylo outdoor



1	SOPYO1900400	pylo outdoor 1900x400mm, 1pc	
2	SOPYO1900600	pylo outdoor 1900x600mm, 1pc	
3	SOPYO1900800	pylo outdoor 1900x800mm, 1pc	



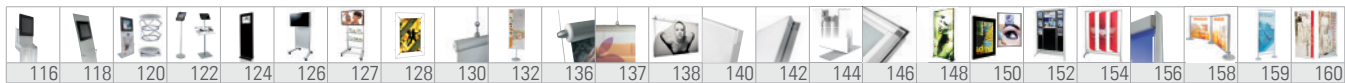

1  
outer

banner not included

# outer

MADE IN SOUTH KOREA quality control by KD

**IT** state cercando un espositore particolarmente stabile e sicuro per le vostre stampe digitali in esterno? in questo caso vi consigliamo il nostro outer. la base in materiale plastico può essere riempita con acqua o sabbia in modo da dare stabilità all'espositore. grazie alla sua particolare struttura potete utilizzare outer per banner di lunghezza e larghezza variabili. ciò viene reso possibile dalla sua asta telescopica e dai bracci laterali flessibili. i bracci superiori sono mobili, non fissi, cosa che rende il montaggio del display estremamente facile e veloce. la struttura di outer è in materiale plastico mentre le barre sono in alluminio: outer è dunque molto leggero. dopo l'utilizzo svuotate la base e riponete struttura e base nella pratica sacca per il trasporto, inclusa nella confezione.

**DE** sie suchen für ihre digitaldruckpräsentation im aussenbereich ein besonders stabiles display? für diesen fall bieten wir ihnen outer. die kunststoff-basis mit wasser oder sand befüllen und schon wirft den outer so leicht nichts mehr um. dank der besonderen konstruktion können sie banner sowohl mit variablen breiten wie längen präsentieren. teleskopauszug und flexible bannerstreben machen es möglich. die oberen bannerstreben sind mit dem auszug beweglich verbunden, so dass ihr outer mit wenigen handgriffen aufgestellt ist. outer ist bis auf die aluminiumstange komplett aus kunststoff. das spart gewicht. nach dem einsatz entleeren sie einfach die basis und verstauen alle teile in der mitgelieferten praktischen tasche.

**EN** looking for a stable outdoor bannerdisplay? then outer is the right choice. fill the plastic base with water or sand and your outer will stand firm and secure. thanks to its special design, outer is suitable for banners with variable width and height. a telescopic pole and the flexible banner bars render this flexibility possible. setting up is easy as the banner bars are already connected to the pole. made of plastic and aluminium, outer is a lightweight. after the job just empty the base and store all parts in the transport bag provided.



regolare la barra di fissaggio inferiore a seconda della larghezza del banner.

*die untere befestigungsschiene auf die bannerbreite einstellen.*

**adjust the lower rail to banner width.**

l'asta telescopica e i bracci di sostegno laterali si inseriscono nella base.

*das teleskopstativ mit den bannerstreben wird in die basis gesteckt.*

**the telescopic pole with banner bars is inserted into the base.**

## information

y-espositore per banner in materiale plastico e alluminio, base riempibile, sacca per il trasporto inclusa

*y-display für banner, aluminium und kunststoff, befüllbare basis, inkl. transporttasche*

**y-display aluminium and plastic, base refillable, transport bag incl.**

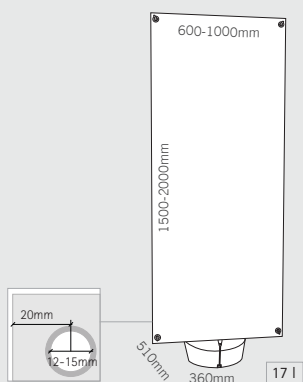

## outer

1 OUTER

outer, 1pc



1  
panelpod

panel not included

# panelpod

MADE IN CHINA quality control by KD

**IT** il display pratico per la presentazione di pannelli sia per l' interno che per l' esterno; riempito con acqua oppure con sabbia, panelpod vi garantirá una presentazione davvero stabile. la sostituzione comoda e veloce nonché il prezzo vantaggioso sono i punti forti della nostra base realizzata in materiale sintetico color nero. particolarmente adatto per pannelli da 10 mm di spessore.

**DE** praktisches paneeldisplay für innen- wie aussenbereich: mit sand oder wasser befüllt garantiert der panelpod standfeste präsentation. bequemer und schneller wechsel sowie ökonomischer preis sind die vorteile des schwarzen kunststoffpräsensters. empfohlen für paneele mit 10mm stärke.

**EN** handy panel display for in- and outdoor: filled with sand or water the panelpod guarantees you a real stable presentation. convenient and quick exchange with budget friendly price are the advantages the black synthetic display will provide you with. best with 10mm thick panels.



## information

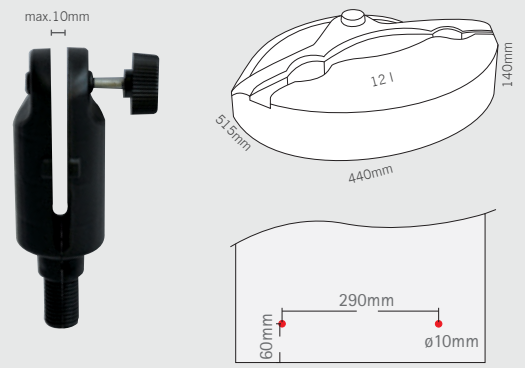

- SINGLE
- DOUBLE
- ~~TELESCOPIC~~
- ~~RETRACTABLE~~
- ~~ELECTRONIC~~
- EXTENSION
- OUTDOOR
- 1,8
- 2,6

## panelpod

1 DPP440SZ panelpod, panel excl., 1pc



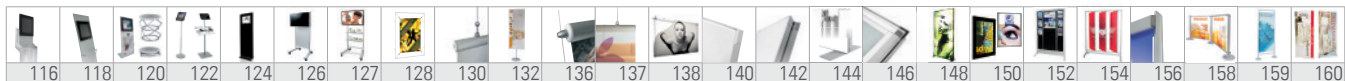

# signwalk

MADE IN EU design by KD

**IT** con signwalk siete sempre in movimento: il design intelligente consente di unire 2 pannelli di qualsiasi materiale, per comporre un elegante display per interni ed esterni. Signwalk può essere utilizzato anche per trasportare comodamente tutta la struttura. Il nostro consiglio: quando non lo utilizzate, chiudete i pannelli, in modo che i lati stampati vadano a trovarsi all'interno – per un trasporto o uno stoccaggio a prova di graffio. signwalk viene fornito singolarmente o, a richiesta, con i pannelli in forex di colore bianco.

**DE** mit signwalk sind sie jederzeit mobil: das clevere design verbindet 2 paneele beliebigen materials zum kundenstopper für in- und outdoor. die verbindungsstange ist zugleich praktischer tragegriff. für transport und lagerung klappen sie beide paneele auf den bedruckten seiten bündig zusammen, so bleibt das decor kratzgeschützt bei reise und lagerung. wir bieten ihnen die struktur sowie passende forex paneele in weiss.

**EN** with signwalk you are mobile: the clever design that turns 2 panels of any material into a display for in- and outdoor. the connector bar is a convenient carrying handle. for transport and storage just fold signwalk with the images inside and it will be protected against scratches during transport and storage. we offer you the structure and matching white forex panels as well.



## information

in zamac color argento e alluminio anodizzato color argento

versilberter metalldruckguss, silber eloxiertes aluminium

silver-plated metal die-cast, silver anodized aluminium

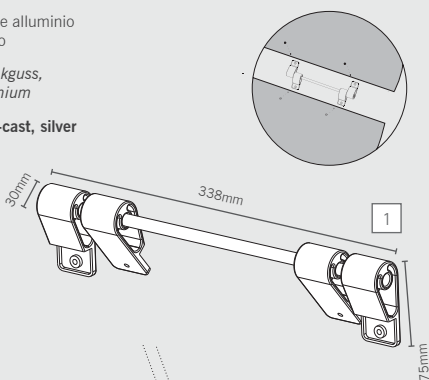

facilmente apribile e richiudibile

einfach schwenkbar zum öffnen bzw. schliessen

rotate for simple opening or closing

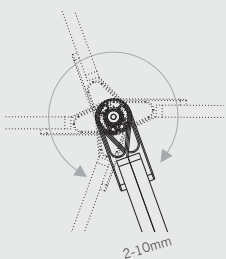

pannello, forex color bianco, 10mm

paneel, forex weiss, 10mm

panel, white forex, 10mm

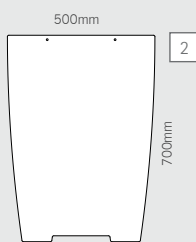

## signwalk

1	DSIW338	signwalk, panel excl., 1pc	
2	DSIW700500W	panel white 700x500mm, 1pc	



# passboard

MADE IN CHINA quality control by KD

**IT** passboard diventa in un attimo un pratico display, basta semplicemente inserire il pannello stampato. una soluzione pratica ed economica per l'interno e l'esterno.

**DE** passboard entfaltet sich in nu zum praktischen präsenter, einfach paneel einschieben fertig. die ökonomische, mobile lösung für innen- wie aussenbereich.

**EN** passboard folds up in no time at all to a walkway display, simply insert the panel and here you go. an economic and mobile application for in- and outdoor.



struttura pieghevole in alluminio anodizzato color argento

*klappbare struktur aus silber eloxiertem aluminium*

**foldable structure made of silver anodized aluminium**

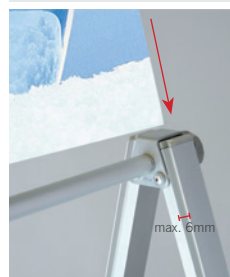

inserire il pannello dal alto  
*paneel von oben einschieben*  
**insert panel from the top**

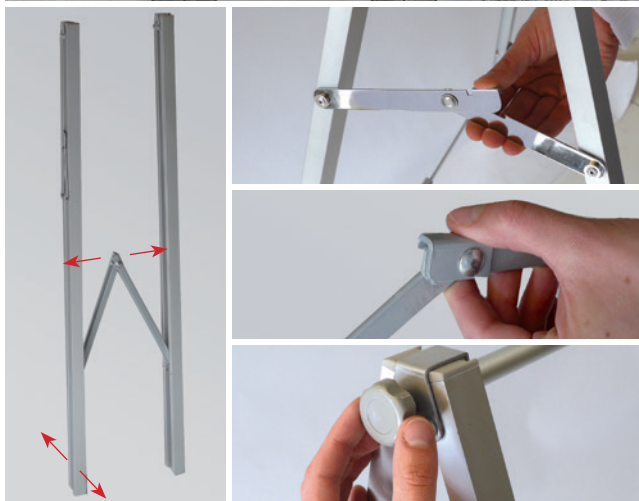

## information



poster size      visible graphic  
605x843x6mm    592x842mm



## passboard

1 DPAB1130

passboard, panel excl., 1pc



**NEW  
PRODUCT**



banner not included

1  
maxiboard



# maxiboard

MADE IN EU design by KD

**IT** un fantastico display per banner in tessuto: è possibile aprire il maxiboard per sostituire velocemente e in qualsiasi momento i banner in tessuto grazie alle strisce in silicone cucite sul banner stesso. tutti gli elementi che lo compongono sono realizzati in alluminio anodizzato di alta qualità in color argento, le parti metalliche sono stampate a pressofusione e i materiali sintetici ad iniezione.

**DE** ein toller kundenstopper für textile banner: das maxiboard lässt sich aufklappen, die textilen banner mit flachkadersystem können jederzeit schnell gewechselt werden. alle teile sind aus hochwertigem silber-eloxiertem aluminium bzw. spritzguss aus metall und kunststoff.

**EN** a perfect A-board display for textile banners: the maxiboard is easily set up. the textile banners can be easily mounted using silicone strips. banner changing also is no big deal at all. all parts are made of high-grade silver anodized aluminium or die-cast parts made of metal and synthetics.

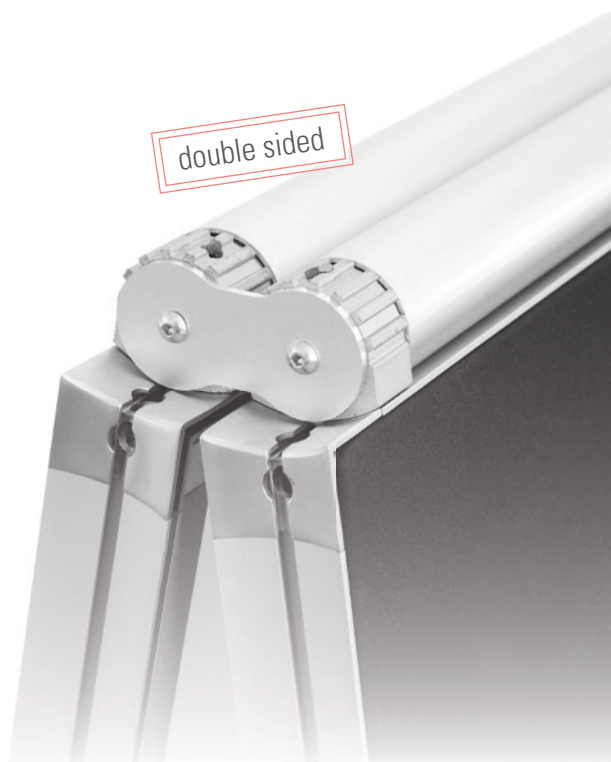

## information

profilo in alluminio anodizzato color argento, metallo stampato a pressofusione, stampa a iniezione dei materiali sintetici

silber eloxiertes alu-profil, metall-druckguss, kunststoff spritzguss

silver anodized aluminium profile, die-cast metal, die-cast synthetics

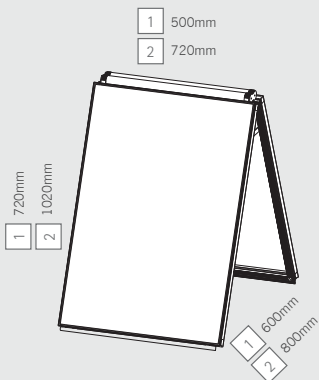

1 bannersize: 720x520mm  
visible size: 700x500mm

2 bannersize: 1020x720mm  
visible size: 1000x700mm

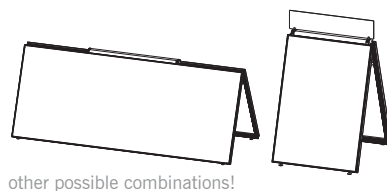

other possible combinations!

## maxiboard <sup>1)</sup>

1	MXB700500	maxiboard 700x500mm, 1pc
2	MXB1000700	maxiboard 1000x700mm, 1pc

1) in vendita da aprile 2013 | auslieferung ab april 2013 | on sale from april 2013

# clip car

MADE IN EU controlled by KD

**IT** stabile cornice a scatto anche per l'esterno: bifacciale e dal design intelligente, che consente anche di trasportarla facilmente. basta ribaltare clip car per posizionarlo sulle rotelle in gomma sintetica, due delle quali sono girevoli, in modo da rendere l'espositore manovrabile con facilità. quando è chiuso, clip car è praticamente immobile, una volta che venga attivato il freno. la vostra informazione sarà al sicuro sotto un foglio protettivo impermeabile e resistente ai raggi UV. grazie all'intelligente meccanismo di trasporto, sarà possibile riportare all'interno velocemente il vostro display, in caso di pioggia.

**DE** stabiler Klapprahmen auch für draussen: doppelseitig mit intelligentem design für leichten transport. clip car einfach hochklappen und schon lässt sich das display auf den vollgummirollen in position bringen. 2 räder sind lenkbar für einfaches manövrieren. zugeklappt steht clip car unbeweglich, da die feststellbremse aktiviert ist. spritzwassergeschützt ist ihre info unter der uv-resistenten abdeckfolie. mit dem cleveren transport-mechanismus können sie das display bei regen schnell ins trockene bringen.

**EN** stable clip frame is also suitable for outdoors: double sided with intelligent design for easy transport. simply push up the display and move it on its solid rubber castors, 2 of which are guidable for easy maneuvering. when closed the clip car is immobile because the brake is activated. your information is splash water protected under the uv-resistant cover foil. with the clever transport system you can move your display quickly out of the rain.



tenuta e stabilità grazie alla base di 40 kg di peso

stabiler stand dank 40kg basis

stable stand thanks to a 40kg base



per rilasciare il freno spingere verso l'alto zum lösen der bremse einfach nach oben klappen

release the brake by simply push up the display



una molla a gas assicura il display durante il trasporto

gasdruckfeder sichert das display während des transports

gas springs holds up safely the display for easy transport



## clip car

1	CLC700500	clip car 700x500mm, 1pc
2	CLC1000700	clip car 1000x700mm, 1pc
3	CLC14001000	clip car 1400x1000mm, 1pc

**NEW PRODUCT**

double sided



## information

cornici in alluminio anodizzato, foglio protettivo resistente ai raggi UV, base verniciata a polveri, rotelle in gomma sintetica

eloxierter aluminium rahmen, uv-beständige abdeckfolie, pulverlackbeschichtete basis, vollgummiräder

anodized aluminium frame, uv-resistant cover foil, powder coated base, solid rubber castors

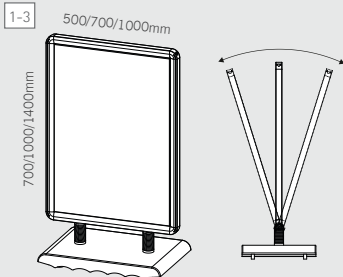



**NEW  
PRODUCT**

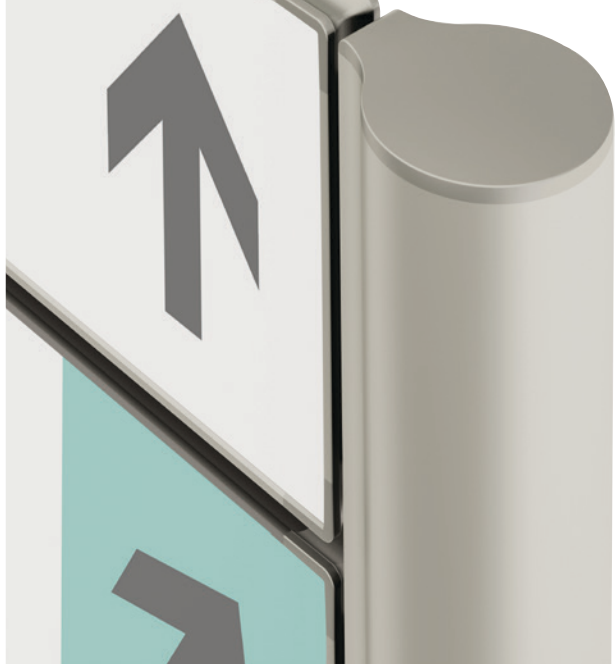

## signcode eXtern

 MADE IN EU design by KD

**IT** una perfetto sistema di segnaletica si vede in primo luogo da come le indicazioni collocate all'esterno accolgono i visitatori. grazie alla nostra nuova gamma di signcode extern bifacciale e flessibile è possibile combinare 45 formati diversi in modo modulare. le indicazioni bifacciali possono essere personalizzate tramite stampa diretta o plastificazione. le indicazioni vengono inserite nel prodotto e sono intercambiabili in qualsiasi momento. i materiali sono di alta qualità e adatti all'uso esterno. grazie alle nostre speciali basi, signcode extern avrà un grande successo anche negli spazi interni.

**DE** zu einem perfektem wegleitungssystem gehört bereits der empfang im aussenbereich. mit unserem doppelseitigem flexiblen signcode eXtern programm können sie 45 verschiedene masse kombinieren und modular gestalten. die doppelseitigen tafeln können mit direktdruck oder laminat personalisiert werden. die tafeln werden eingeschoben und sind jederzeit austauschbar. alle materialien sind hochwertig und für den aussenbereich geeignet. aber auch im innenbereich macht signcode eXtern mit unseren speziellen basen eine gute figur.

**EN** perfect signage welcomes visitors already to the outdoor area. with our double sided flexible signcode eXtern program you can combine 45 different sign sizes and design them in a modular way. the double sided signs can be customized with direct print or lamination. the signs are simply inserted and can be exchanged at anytime. all materials used are high grade and perfect for outdoor use. but also for indoors, you can use signcode eXtern with our special bases.

### ideas

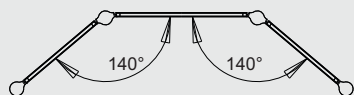

i moduli possono essere piegati fino a 140°

module können stufenlos bis 140° geneigt werden

modules can be positioned stagelessly up to 140°

ulteriori informazioni pag. mehr details s. more information p.

## information

alluminio anodizzato color argento, con tappi superiori in argento realizzati in pressofusione, A monolaterale per delimitare zone esterne, B bilaterale per posizionamento centrale

silber eloxiertes aluminium, kappen aus versilbertem metall-druckguss, A einseitig für aussenbegrenzung, B zweiseitig für mittige position

silver anodized aluminium, caps made of silver plated die-cast metal, A single sided for outside posts, B double sided for center posts

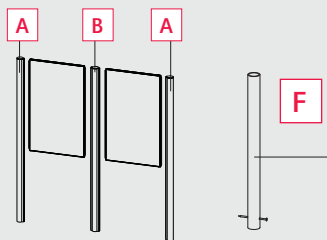
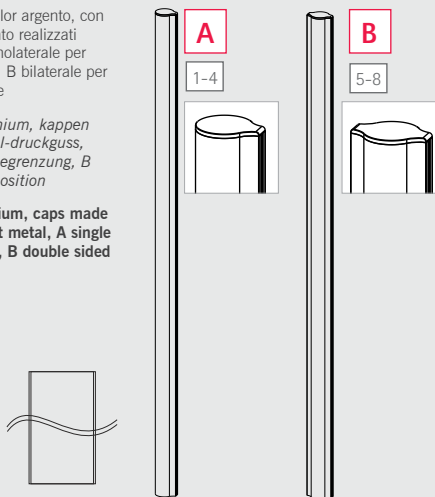

combinare a piacimento tubi e basi da pavimento corrispondenti

kombinieren sie pfosten und entsprechende bodenhalterungen

choose these posts with the needed ground sleeves

bussole da terra per calcestruzzo o fondamenta in cemento

bodenhülse für beton oder zement fundamente

ground sleeve for concrete installation

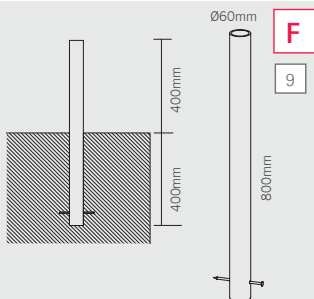

targhe bifacciali con cornici in alluminio anodizzato color argento, angoli realizzati in metallo pressofuso satinato color argento, lastra in alluminio con rivestimento bianco

doppelseitige tafeln mit silber eloxiertem aluminium profilrahmen, matt versilberten metall druckguss ecken, aluminium platten weiss beschichtet.

double sided signs with silver anodized aluminium frame, matt silver plated die-cast metal corner connectors, aluminium panels with white coating

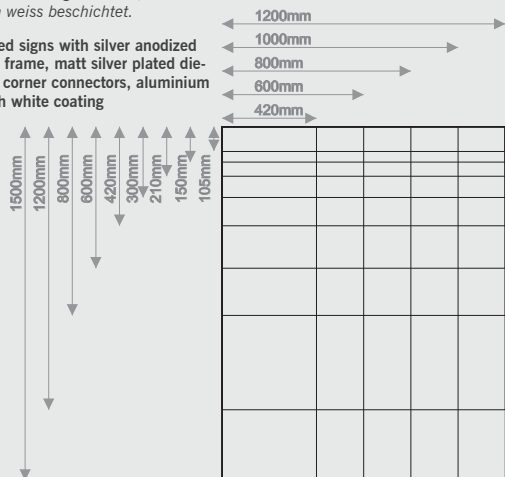

## signcode eXtern <sup>1)</sup>

1	SCXPAV1200	post A 1200mm, 2pcs
2	SCXPAV1500	post A 1500mm, 2pcs
3	SCXPAV1800	post A 1800mm, 2pcs
4	SCXPAV2000	post A 2000mm, 2pcs
5	SCXPMV1200	post B 1200mm 1pc
6	SCXPMV1500	post B 1500mm 1pc
7	SCXPMV1800	post B 1800mm 1pc
8	SCXPMV2000	post B 2000mm 1pc
9	SCXGROUND	ground sleeve F, 1pc
10	SCX105420	s. extern 105x420mm, 1pc
11	SCX105600	s. extern 105x600mm, 1pc
12	SCX105800	s. extern 105x800mm, 1pc
13	SCX1051000	s.extern 105x1000mm, 1pc
14	SCX1051200	s.extern 105x1200mm, 1pc
15	SCX150420	s.extern 150x420mm, 1pc
16	SCX150600	s. extern 150x600mm, 1pc
17	SCX150800	s. extern 150x800mm, 1pc
18	SCX1501000	s. extern 150x1000mm, 1pc
19	SCX1501200	s. extern 150x1200mm, 1pc
20	SCX210420	s. extern 210x420mm, 1pc
21	SCX210600	s. extern 210x600mm, 1pc
22	SCX210800	s. extern 210x800mm, 1pc
23	SCX2101000	s. extern 210x1000mm, 1pc
24	SCX2101200	s. extern 210x1200mm, 1pc
25	SCX300420	s. extern 300x420mm, 1pc
26	SCX300600	s. extern 300x600mm, 1pc
27	SCX300800	s. extern 300x800mm, 1pc
28	SCX3001000	s. extern 300x1000mm, 1pc
29	SCX3001200	s. extern 300x1200mm, 1pc
30	SCX420420	s. extern 420x420mm, 1pc
31	SCX420600	s. extern 420x600mm, 1pc
32	SCX420800	s. extern 420x800mm, 1pc
33	SCX4201000	s. extern 420x1000mm, 1pc
34	SCX4201200	s. extern 420x1200mm, 1pc
35	SCX600420	s. extern 600x420mm, 1pc
36	SCX600600	s. extern 600x600mm, 1pc
37	SCX600800	s. extern 600x800mm, 1pc
38	SCX6001000	s. extern 600x1000mm, 1pc
39	SCX6001200	s. extern 600x1200mm, 1pc
40	SCX800420	s. extern 800x420mm, 1pc
41	SCX800600	s. extern 800x600mm, 1pc
42	SCX800800	s. extern 800x800mm, 1pc
43	SCX8001000	s. extern 800x1000mm, 1pc
44	SCX8001200	s. extern 800x1200mm, 1pc
45	SCX1200420	s. extern 1200x420mm, 1pc
46	SCX1200600	s. extern 1200x600mm, 1pc
47	SCX1200800	s. extern 1200x800mm, 1pc
48	SCX12001000	s. extern 1200x1000mm, 1pc
49	SCX12001200	s. extern 1200x1200mm, 1pc
50	SCX1500420	s. extern 1500x420mm, 1pc
51	SCX1500600	s. extern 1500x600mm, 1pc
52	SCX1500800	s. extern 1500x800mm, 1pc
53	SCX15001000	s. extern 1500x1000mm, 1pc
54	SCX15001200	s. extern 1500x1200mm, 1pc

1) in vendita da giugno 2013 | auslieferung ab juni 2013 | on sale from june 2013





**NEW PRODUCT**

flag not included

# flag fix

MADE IN EU design by KD

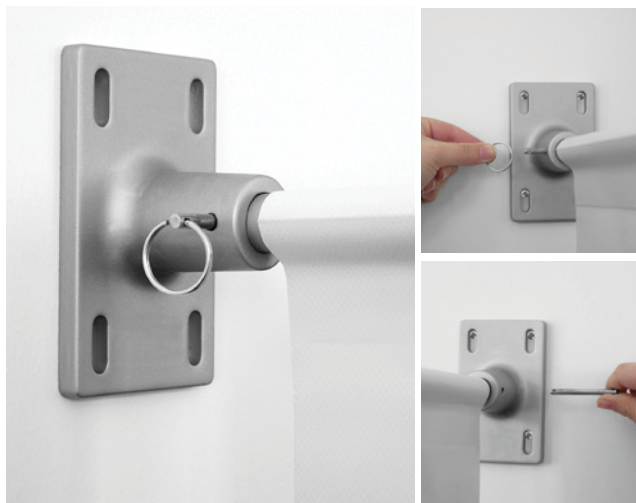

**IT** il sistema di fissaggio perfetto per bandiere di grande formato da fissare a edifici o pali della luce ma anche per ambienti interni come centri commerciali o padiglioni fieristici. una coppia blocca l'asta della bandiera nel supporto a parete. innovativo il sistema di livellatura orizzontale che permette di equilibrare e mantenere il banner ben in tensione anche in presenza di difetti e imperfezioni della parete. tutti i materiali sono di alta qualità e adatti anche per uso esterno.

**DE** die ideale auslegerbefestigung für grossformatige fahnen an fassaden und lichtmasten, aber auch im innenbereich von shopping malls oder messehallen. ein splint sichert die fahnenstange im halter. clever die horizontale livellierung: so können sie unebenheiten der mauer ausgleichen und auch die banner spannen. alle materialien sind hochwertig und für den aussenbereich geeignet.

**EN** the perfect fixing for large-format flags on buildings and lamp posts, also indoors at shows or exhibition halls. a splint pin locks the flag pole in the wall support. also clever is the horizontal leveling: thus you can counter balance any unevenness of walls and tension the banners. all materials are first-grade and good for outdoor use.



## information

metallo satinato di alta qualità color argento stampato a pressofusione, profili in alluminio anodizzato color argento

hochwertiger silber matt veredelter metalldruckguss, silber eloxiertes aluminiumprofil

high-quality silver matt plated metal die-cast, silver anodized aluminium profile

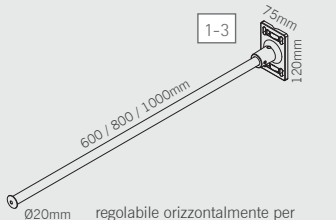

regolabile orizzontalmente per posizionare e tendere perfettamente la bandiera

horizontal regulierbar für perfekte ausrichtung und flaggen spannung

horizontally adjustable for a perfect look and tensioning of the flag

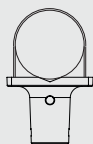

fissaggio su superfici circolari (palo della luce): incastro perfetto grazie alla scanalatura presente nella parte posteriore

befestigung auf runden oberflächen (lichtmast): automatisch perfekter sitz dank rückseitiger einkerbung

mounting on round surfaces (lamp posts): automatically a perfect fit thanks to the notches to the rear



fissaggio perfetto grazie alla fascetta, di 10mm max. di altezza.

perfekte befestigung mit bandschellen mit max. 10mm

easy to mount with clips max. 10mm

## flag fix <sup>1)</sup>

1	FGF600	flag fix 600mm, 1pc
2	FGF800	flag fix 800mm, 1pc
3	FGF1000	flag fix 1000mm, 1pc

1) in vendita da aprile 2013 | auslieferung ab april 2013 | on sale from april 2013



# big fix

MADE IN EU design by KD

**IT** sistema versatile e conveniente di fissaggio per banner, big fix vi offre una grande varietà di soluzioni: può essere usato come semplice gancio per la pubblicità di grande formato da applicare sulle facciate degli edifici o sulle aste delle bandiere per il fissaggio del banner; le fascette vi permetteranno di fissarlo anche ai lampioni o su altri pali. grazie alle scanalature nella parte posteriore bigfix rimarrà perfettamente perpendicolare alla superficie circolare. metallo di alta qualità stampato a pressofusione adatto anche per uso esterno.

**DE** diese bannerbefestigung lässt sich vielfältig einsetzen und ist dabei auch noch günstig! ob als einfacher haken für eine big-print fassadenwerbung oder mit den fahnenstangen als bannerbefestigung, mit big fix sind sie gut beraten. sogar an lichtmasten und pfeosten lässt sich der big fix mit bandschellen montieren. dank der rückseitigen einkerbung richtet er sich automatisch perfekt gerade an der runden oberfläche aus. hochwertiger metall-druck-guss für den aussenbereich.

**EN** this banner fixing can be used in many different ways and is a real bargain! our big fix can be used as a simple mounting hook for large-format banners or with the poles as flag banner mounting. you can even use the big fix on lamp posts and poles with clips. thanks to the notches on the rear it adjusts automatically straight around the surface of the post. high-grade die-cast metal for outdoors.



fissaggio perfetto grazie alla fascetta, di 10mm max. di altezza

perfekte befestigung mit bandschellen mit max. 10mm

easy to mount with clips max. 10mm

## information

metallo satinato di alta qualità color argento stampato a pressofusione, profili in alluminio anodizzato color argento

hochwertiger silber matt veredelter metall-druckguss, silber eloxiertes aluminiumprofil

high-quality silver matt plated die-cast metal, silver anodized aluminium profile

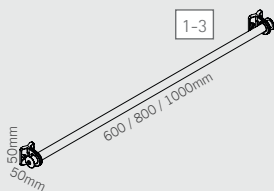

metallo satinato di alta qualità color argento stampato a pressofusione

hochwertiger silber matt veredelter metall-druckguss

high-quality silver matt plated die-cast metal

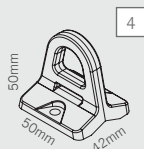

## big fix <sup>1)</sup>

1	BGF600	big fix 600mm, 1pc
2	BGF800	big fix 800mm, 1pc
3	BGF1000	big fix 1000mm, 1pc
4	BGM5042	big fix fixing set 4pcs, 1pc

1) in vendita da aprile 2013 | auslieferung ab april 2013 | on sale from april 2013





banner not included

# monsterframe

MADE IN EU design by KD patented

**IT** monsterframe per stampe giganti: IL prodotto giusto per le vostre MEGA stampe pubblicitarie out-of-home. sistema di fissaggio semplice da usare, per fissare banner pubblicitari in pvc o vinile in ambito interno ed esterno. design all'avanguardia e alta qualità caratterizzano monsterframe. il sistema di fissaggio del banner è davvero intelligente: basta inserire i buttons nella cava del profilo. i buttons possono essere cambiati in ogni momento, anche dopo il montaggio. il banner quindi può essere appeso facilmente da UNA sola persona, senza bisogno di smontare l'intera struttura e senza l'uso di speciali attrezzi. per il fissaggio stesso del banner ci sono a disposizione varie possibilità. nelle prossime pagine potrete trovare altre informazioni!

**DE** monsterframe für gigaprints: DAS produkt für ihre BIGprints im out-of-home marketing. anwenderfreundliches befestigungssystem für werbebanner von pvc-plane bis netzvinyl im außen- und innenbereich. patente design- und produktqualität zeichnen monsterframe aus. alle teile sind robust, langlebig, hochwertig und wiederverwendbar. besonders clever ist die bannerbefestigung. bannerbuttons werden einfach in die rückseitige profilnut eingesetzt. die buttons können jederzeit - auch nach der montage - eingesetzt oder entnommen werden. das banner kann dadurch von EINER person, OHNE demontage des rahmens und OHNE werkzeug auf- und abgehängt werden. für die bannerbefestigung selbst stehen gleich mehrere möglichkeiten zur auswahl. auf der nächsten seite finden sie mehr!

**EN** monsterframe for giga prints: THE product for your BIG prints in the out-of-home marketing sphere. user-friendly in- and outdoor mounting system for advertising banners made of pvc or net vinyl. smart design and high-grade quality is what monsterframe stands for. all parts are robust, durable, top-quality and reusable. the banner mounting is especially clever. the buttons are simply inserted into the profile's notches. buttons can be replaced at anytime - even after-mounting. the banner can be hung up and taken down by ONE person, with NO demounting and NO tools. for the banner's mounting itself we have several clever possibilities. check out more on the following page.



1 campione per showroom completo di banner

showroom muster mit banner

sample for your showroom with banner

## monsterframe

1 MFMUS600500

sample monsterframe, 1pc





banner not included



angoli in alluminio stampato con verniciatura a polvere color argento

*eckverbinder aus aluminium druckguss mit silber pulverlackbeschichtung*

**corner bracket made of aluminium die-cast silver powder coated.**



inserire e fissare con vite

*einstecken und mit gewindestift sichern*

**insert and fix with screw**



inserire i buttons nella cava del profilo

*banner buttons in die rückwärtige profinut einsetzen*

**insert banner buttons into the rear notch of the profile**



esercitare una rotazione di 90°

*drehen um 90°*

**turn 90°**



pronto e sicuro per il montaggio del banner

*sicher befestigt für die bannermontage*

**securely fastened for banner mounting**

fissaggio sicuro con supporti in alluminio adatti per interno ed esterno

*wandbefestigung mit wetterfestem aluminium schellen für innen und aussen*

**wall mount with weather-proof aluminium couplers for in- and outdoor**





# monsterframe



banner not included



1-5

profilo in alluminio anodizzato Ø50mm, pretagliato, conf. 1 pz.

*silber eloxierte aluminiprofile Ø50mm, montagefertig abgelängt, je 1 stange.*

**silver anodized aluminium extrusion Ø50mm, 1bar, precutted.**



6

angoli stampati in alluminio, verniciati in color argento, 4 pz.

*eckverbinder alu druckguss, silber pulverlack beschichtet, 4stk.*

**corner connector aluminium diecast, silver metallic coated, 4 pcs.**



7

connettore a T in metallopressofuso color argento, per composizioni modulari e sempre nuove del vostro monsterframe

*t-verbinder für modulare gestaltung der monsterframes aus metalldruckguss silber lackiert*

**t-connector for modular composition of the monsterframe, zamac die-cast, silver metallic coated**

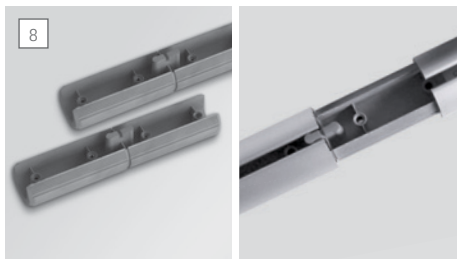

8

connettore per profili in alluminio stampato con verniciatura a polvere, lunghezza 200mm, conf. da 2 pz.

*profilverbinder aus metalldruckguss, länge 200mm, set mit 2 stk.*

**profile connectors in powder coated moulded aluminium, length 200mm, pack with 2 pcs.**



9

fissaggio murale con aggancio in alluminio munito di 3 fori per il fissaggio a parete, materiale per il montaggio incluso, conf. 2 pz

*wandschelle, 3-punkt befestigung, aluminium für innen und aussen, mit montagmaterial set 2 stk.*

**wall mounting support with 3 point fixing, made of aluminium, incl. mounting material, pack with 2 pcs.**



10

fissaggio murale con aggancio in alluminio munito di un foro per il fissaggio a parete, materiale per il montaggio incluso, conf. 2 pz

*wandschelle, 1-punkt befestigung, aluminium für innen und aussen, mit montagmaterial set 2 stk.*

**wall mounting support with 1 point fixing, made of aluminium, incl. mounting material, pack with 2 pcs.**



banner buttons per fissaggio banner, grigi, conf. da 20 pz.

banner buttons für die montage des banners, grauer kunststoff, packung mit 20stk.

buttons for mounting grey synthetic, pack with 20 pcs.



clamp gancio istantaneo, non occorre forare i tessuti, riutilizzabile.

clamp bannerklemme für befestigung ohne öse oder loch, wiederverwendbar, hält auf zug, box 20st.

clamp for banner white, holds without holes or eyelets, reusable, box 20pcs.



anello trasparente elastico Ø60mm, materiale: silicone

gumming transparent Ø60mm, material: silikon

plastic transparent rings Ø60mm made of silicon



elastico con gancio grigio Ø30mm, in materiale PES, gancio zincato, conf. da 20pz.

gummiexpander grau Ø30mm, material PES, haken verzinkt, packg. 20st.

elastic expander grey Ø30mm, made of PES, hook zincplated, box 20pcs.

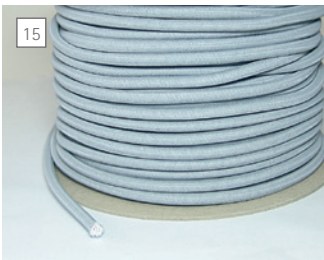

elastico grigio Ø6mm, in materiale PE, rotolo 50m

gummikabel grau Ø6mm, material PE, rolle mit 50m.

elastic rope grey, Ø6mm, made of PE, roll 50m.

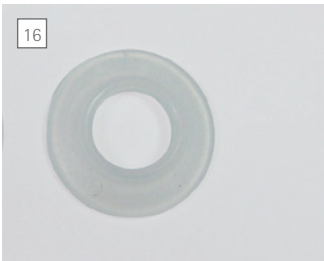

occhielli con chiusura a scatto. mat.: polipropilene bianco. dimensioni: interno Ø12mm, esterno Ø30mm, conf. da 50pz.

ösen mit schnappmechanismus. mat.: polypropylen, weiss. grösse: innen Ø12mm, aussen Ø30mm. packg. 50st.

snapping eyelet. mat.: polypropylene, white. size: inside Ø12mm, outside Ø30mm. box 50pcs.

**IT** i profili di questo sistema modulare sono disponibili sia in lunghezze standard che lunghi 6.5 m, per essere poi tagliati a piacere. per il fissaggio sono disponibili fissaggi in alluminio, bannerbuttons e pratici occhielli, elastico grigio ed elastici con ganci. tutto quello di cui avete bisogno per il vostro monsterframe è disponibile in internet su [www.frame-tool.com](http://www.frame-tool.com), dove troverete un pratico programma con il quale potrete configurare esattamente ed in pochi click il vostro monsterframe. il tool vi preparerà una lista di acquisto di tutti i pezzi necessari, che potrete spedire via fax al vostro rivenditore. tutti i pezzi sono robusti, durevoli nel tempo, di alta qualità e riutilizzabili.

**DE** das modulare stecksystem ist in standardlängen oder als stangenware zum selberschneiden erhältlich. für die befestigung finden sie aluminiumschellen, bannerbuttons sowie praktische ösen, gummikabel und expander. was sie alles für ihren monsterframe brauchen, können sie ganz einfach im internet unter [www.frame-tool.com](http://www.frame-tool.com) berechnen. dort finden sie einen praktischen rechner, mit dem sie ihren monsterframe massgenau mit wenigen clicks konfigurieren. das tool stellt ihnen dazu die richtige einkaufsliste für alle teile zusammen. diese liste faxen sie dann direkt an ihren händler. alle teile sind robust, langlebig, hochwertig und wiederverwendbar.

**EN** the profiles for this modular system are available in standard lengths or, order 6.5m profiles and machine cut them to your own specifications. for mounting you'll find aluminium supports, banner buttons and eyelets, elastic cords and expanders as well. everything you need for your monsterframe can easily be figured out with the calculator on the website [www.frame-tool.com](http://www.frame-tool.com). with this virtual tool you can configure your frame with just a few clicks. the tool prepares your purchase list for all the parts needed. you can print and fax this list directly to your retailer. all parts are robust, durable, high-quality and reusable.

[www.frame-tool.com](http://www.frame-tool.com)

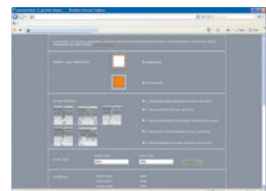

## monsterframe

1	MFP1100AL	profile, 1100mm, 1pc	
2	MFP2100AL	profile, 2100mm, 1pc	
3	MFP3100AL	profile, 3100mm, 1pc	
4	MFP4100AL	profile, 4100mm, 1pc	
5	MFP5100AL	profile, 5100mm, 1pc	
6	MFA110AR	corner connector, 4pcs	
7	MFTANG02	t-connector, 2pcs	
8	MFV400AL	cross connector, 2pcs	
9	MFWH03AL	3 point wall mounting support, 2pcs	
10	MFWH01AL	1 point wall mounting support, 2pcs	
11	MFTP22GR	banner buttons, 20pcs	
12	ACL3540WE	clamp for banner, 20pcs	
13	AGK60TR	elastic ring, 20pcs	
14	AGK30GR	elastic expander, 20pcs	
15	MFGK06GR	elastic rope, 50m	
16	AEY3012TR	eyelet in polypropylene, 50pcs	



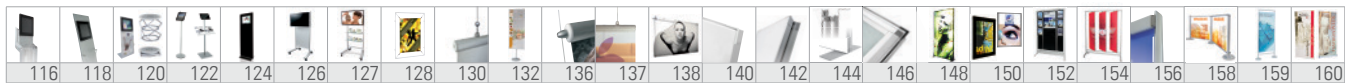

# angelframe



MADE IN EU design by KD

patented

## information

frame length = profile + 260mm

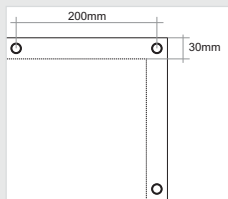
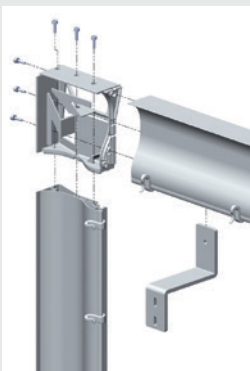
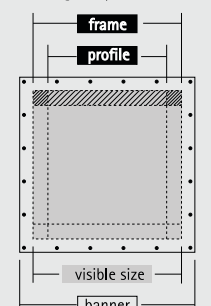

**IT** angelframe rimane discreto ed invisibile nella parte posteriore delle vostre stampe digitali di grande formato, dandovi così la possibilità di esporre le vostre presentazioni senza cornici laterali. gli angoli vengono avvitati direttamente, e quindi in modo decisamente sicuro, sui profili; per questo motivo non c'è bisogno di tagliare i profili a 45°. dadi e clip per banner possono essere inseriti nel profilo anche dopo aver effettuato il montaggio. il bordo del banner viene agganciato alla parte posteriore del profilo: il fissaggio posteriore vi permette di nascondere facilmente eventuali irregolarità del banner. il montaggio di angelframe vi farà risparmiare tempo e denaro: lo stesso cambio del banner, grazie al design e alla funzionalità intelligente, è facile, veloce e attuabile senza l'utilizzo di utensili.

**DE** angelframe hält sich bei den large-formats dezent unsichtbar im hintergrund und präsentiert ihr big-format rahmenlos. die ecken werden direkt und damit besonders stabil mit dem profil verbunden. profile können gerade und ohne gehrung geschnitten werden. die nutsteine lassen sich einklicken, ebenso wie die bannerclips, d.h. auch schon montierte rahmen können noch ergänzt werden. der bannerrand wird über das rahmenprofil gezogen und bleibt unsichtbar. ungenauigkeiten bei zuschnitt oder säumung fallen damit nicht mehr auf. insgesamt ist die montage zeit- und kostensparend, ebenso der banner-austausch ist durch das clevere design unkompliziert und ohne werkzeug jederzeit möglich.

**EN** angelframe is backstage when it comes to presenting large-formats. the structure holds your banner framelessly. the edges are directly and firmly connected to the extrusions so it is not necessary to mitre the profiles. the threads for wall fixing and the banner clips can be clicked in to place even after mounting. the banner seam is pulled over the frame profile, thus hiding imprecise cuts or seams. all in all, the mounting saves time and money, the banner exchange is easy and does not require tools and is possible at anytime.

1-4

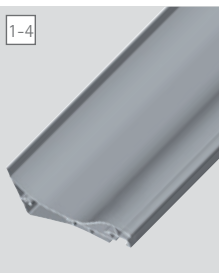

alluminio anod. argento, misure per lunghezza visibile 1-4m o per taglio

silber elox-alu, längen für banner-sichtfläche 1-4m oder meterware

silver anod. aluminium, size for visible length 1-4m or meter to cut

5



fissaggio a muro, metallo zincato, incl. materiale di montaggio, 1pz

wandhalter metall verzinkt, inkl. montagematerial, 1st.

wall mounting support, galvanised metal, incl. mounting material, 1pc

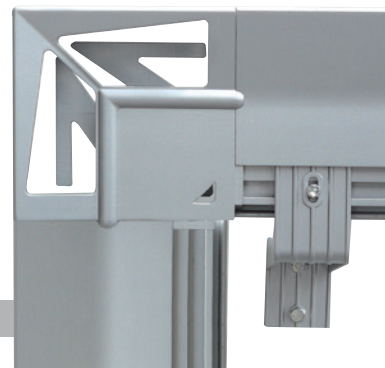



montare il gancio a parete, fissare i dadi nel profilo - siccome non vengono inseriti nella cava, è possibile aggiungerne anche dopo aver terminato il montaggio della struttura. fissare il profilo al gancio. distanza dalla parete del banner: 130mm

*montage der wandhalterung, nutstein einklicken - da kein einschub, ist das auch nach (!) erfolgter montage möglich - profil montieren. wandabstand banner: 130mm*

**mount the wall support, click in the washer - thanks to this you can click in more washers also after (!) mounting - fix the profile. wall distance for banner: 130mm**



agganciare le clip al profilo, nella quantità desiderata, prima o dopo il montaggio della struttura; gancio per elastico che ne semplifica l'assemblaggio e lo mantiene perfettamente in tensione.

*banner clips einfach ans profil klicken, jederzeit und so viele wie nötig, auch nach der montage. mit führung für das gummi-kabel: erleichtert das spannen und verhindert herausrutschen.*

**simply click the clips to the profile, anytime and as many as you need, even after assembling of the structure. with channel for the elastic cord: eases the tightening of the cord and prevents it from slipping out.**



montaggio ad angolo del banner senza pieghe : funzionalità intelligente fin nei più piccoli dettagli. gli angoli sono provvisti di scanalature nelle quali inserire agevolmente il banner. in questo modo potrete tensionare il vostro banner comodamente e facilmente.

*faltensfreie eck-montage: clevers design auch hier. die eckverbinder haben eine nut, in die sie einfach die bannerecken ziehen. so spannen sie ihr banner im nu faltensfrei und sauber!*

**crease free mounting of the angles: the clever design provides a solution as well. all the edge connectors come with a slot where you simply pull through the banner ends. thus you tighten your banner quickly crease free and neat!**

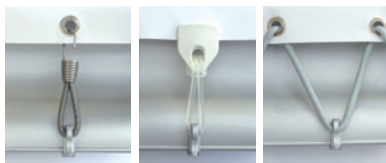

come per monsterframe, il sistema angelframe vi offre varie possibilità per il fissaggio del banner al profilo, si veda pag. 197

*gleich wie monsterframe hat auch der angel diverse banner-befestigungsmöglichkeiten, mehr auf s. 197*

**like monsterframe angel has also different possibilities to fix the banner. see p. 197 for more details**



il connettore angelframe, per composizioni modulari, deve essere fissato ad un gancio murale. i profili risulteranno così connessi grazie a questo accessorio. in caso di utilizzo del connettore AFCON2, considerare 10mm in meno, per ogni connettore, sulla lunghezza dei profili.

*der connector für die modulare gestaltung muss an einer wandhalterung angebracht werden. die profile werden mittels connector verbunden. bei verwendung der verbinder AFCON2 muss die profillänge je verbinder um 10mm gemindert werden.*

**the connector for modular design of angelframe must be mounted directly to the wall mounting support. the profiles can then be connected directly. when using connectors AFCON2 calculate 10mm less profile length for each connector used.**

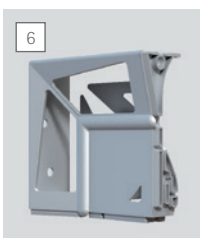

angoli in zamac color argento, 4pz

*eckverbinder metalldruckguss versilbert, 4st.*

**corner connector metal die-cast, silver coated, 4pcs**



connettore in alluminio stampato con verniciatura a polvere 2pz

*verbindungsstück aus metalldruck-guss, 2st*

**connector in powder coated moulded aluminium 2pcs**



banner clips, nylon color grigio, 20pz

*banner clips, nylon grau, 20st*

**banner clips, grey nylon, 20pcs**

[www.frame-tool.com](http://www.frame-tool.com)



## angelframe

1	AFP1000AL	for 1m visible banner length, profile 740mm, 1pc	
2	AFP2000AL	for 2m visible banner length, profile 1740mm, 1pc	
3	AFP3000AL	for 3m visible banner length, profile 2740mm, 1pc	
4	AFP4000AL	for 4m visible banner length, profile 3740mm, 1pc	
5	AFWHD01	wall support, 1pcs	
6	AFAN04AR	edge connector, 4pcs	
7	AFCON02	angelframe connector, 2pcs	
8	AFC20GR	banner clips, 20pcs	



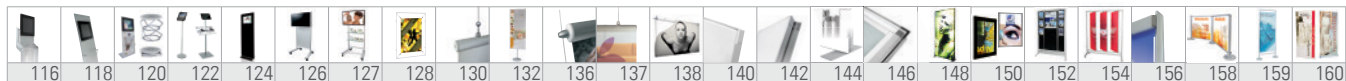

banner not included



# leoframe

 MADE IN EU design by KD

**IT** leoframe è un sistema a scomparsa, ideale per interni ed esterni, particolarmente robusto e che può essere utilizzato come sistema mono- e bifacciale. i banner vengono fissati lateralmente sul profilo grazie ad un listello decorativo. affinché leoframe possa essere utilizzato anche come sistema autoportante, in loco durante il montaggio sono da prevedere strutture ausiliarie. le traverse, con un angolo di 90° o 45° possono essere aggiunte alla struttura anche dopo l'installazione del sistema, senza doverlo rismontare. grazie a questi connettori, leoframe può essere utilizzato anche per realizzare strutture tridimensionali.

**DE** leoframe für den innen und aussenbereich ist ein besonders stabiles rahmenloses systems. sie können es ein- oder doppelseitig einsetzen. die banner werden mit einer dekorschiene seitlich befestigt. für die freistehende verwendung sind bauseitig entsprechende strukturen vorzusehen. traversen können im 90° oder 45° winkel jederzeit auch nachträglich ohne demontage des rahmens eingesetzt werden. dank dieser verbinder kann leoframe sogar für 3 dimensionale strukturen verwendet werden.

**EN** leoframe is a very stable frameless system for in or outdoor. you can use it both single or double-sided. banners are mounted with a lateral fixing lace. for the freestanding structures the required mounting must be provided by customers. cross beams can be mounted with 90° or 45° anytime without any disassembling of the frame. thanks to the special connector design even 3 dimensional structures are possible.

## information

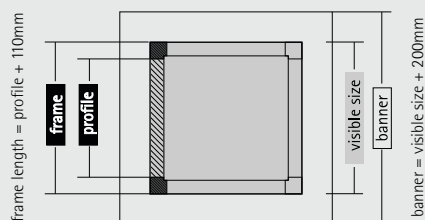

appoggiare il banner  
*banner anlegen*  
position the banner



inserire il listello di fissaggio  
**befestigungslitze anlegen**  
position the fixing lace



spingere il listello nella cava del profilo con un martello di gomma  
*litze mit gummihammer einschlagen*  
**fix the lace using a rubber hammer**



banner not included



profilo in alluminio anodizzato, angoli in alluminio stampato con verniciatura a polvere, 4pz

*silber eloxiertes aluminiumprofil, eckverbinder aus metalldruckguss 4 st*

**silver anodized aluminium profile, corner connector in powder coated moulded aluminium, 4pcs**

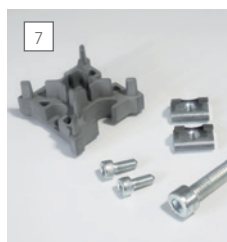

connettore in alluminio stampato con verniciatura a polvere, 2p

*verbinder aus metalldruckguss, 2st*

**connector in powder coated moulded aluminium, 2pcs**

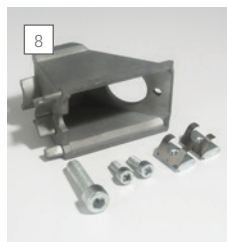

connettore in alluminio stampato con verniciatura a polvere, 2pz

*verbinder aus metalldruckguss, 2st*

**connector in powder coated moulded aluminium, 2pcs**



fissaggio murale in metallo verniciato color argento, materiale per il montaggio incluso, 2pz

*wandhalterung aus silber lackiertem metall, inkl. montagematerial, 2st*

**leoframe wall support made of silver varnished metal, incl. mounting material, 2pcs**



per un fissaggio invisibile del supporto murale, montare prima la struttura e poi agganciare il banner.

*bei unsichtbarer montage des wandhalter, zuerst den rahmen wandmontieren, dann banner befestigen.*

**for invisible mounting of the wall fixing: first mount the frame to the wall, then fix the banner.**



se volete fissare il banner prima del montaggio a parete, fissare il supporto murale come nell'immagine: il supporto murale rimane visibile.

*wollen sie den banner vor der wandmontage befestigen, wandhalter wie abgebildet montieren, der wandhalter bleibt sichtbar.*

**should you want to mount the banner before wall mounting the frame, set the wall support as pictured, wall support will remain visible.**

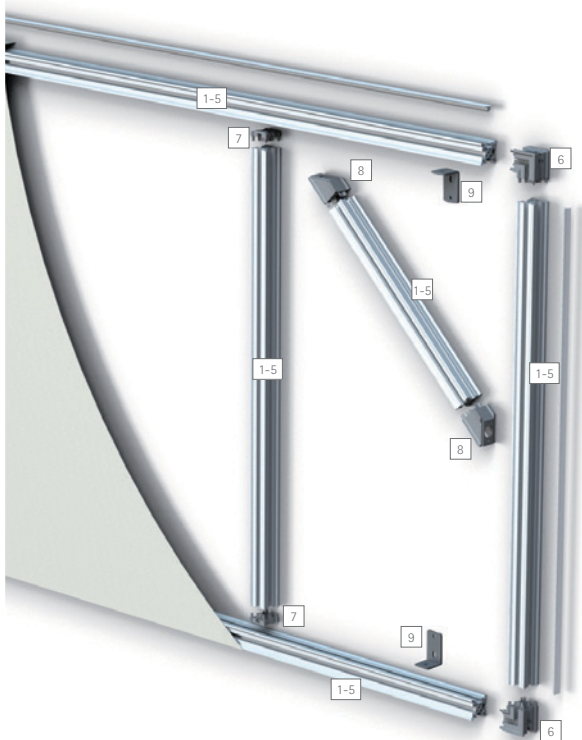

## leoframe

1	LFP1000	leoframe profile 890mm, 1pc
2	LFP2000	leoframe profile 1890mm, 1pc
3	LFP3000	leoframe profile 2890mm, 1pc
4	LFP4000	leoframe profile 3890mm, 1pc
5	LFP5000	leoframe profile 4890mm, 1pc
6	LFANG04	leoframe corner connector, 4pcs
7	LFAD02	leoframe adapter, 2pcs
8	LF45CON02	leoframe 45°connector, 20pcs
9	LFRWS	leoframe wall support, 2pcs



# tripole & giantpole

 MADE IN SOUTH KOREA quality control by KD

**IT** sono mobili ma robusti e con un'altezza rispettivamente di 5,4 mt (giantpole) e 4 mt (tripole) si fanno proprio notare. non importa che sia per manifestazioni sportive, eventi culturali, fiere, convegni o promozioni pubblicitarie, giantpole e tripole creano un bel colpo d'occhio. l'asta per la bandiera e i sostegni laterali sono in alluminio anodizzato. la base in materiale plastico può essere riempita di acqua o di sabbia. quando la base è riempita completamente, giantpole e tripole possono essere utilizzati all'esterno con un vento massimo di 14m/s (50,4 km/h). inserire il portabandiera sulla base, attaccare la bandiera, allungare l'asta e il gioco è fatto. base e asta non sono vendibili singolarmente.

**DE** mobil, stabil und robust sind giantpole und tripole. bei einer höhe von 5,4m (giantpole) bzw. 4m (tripole) fallen sie ganz sicher auf. egal ob sportveranstaltung, kulturevent, messe oder werbeaktion, die mobilen giant- und tripole sind ein echter hingucker. fahnenstange und gestänge sind aus eloxiertem aluminium. die kunststoff-basis kann mit wasser oder sand gefüllt werden. mit gefüllter basis halten giant- und tripole windgeschwindigkeiten bis zu 14m/s (50,4km/h) stand. gestänge in die basis stecken, fahne befestigen und den mast ausziehen, fertig. basis und mast können nicht einzeln bestellt werden.

**EN** mobile, stable and robust are giantpole and tripole. with 5,4m (giantpole) and 4m (tripole) you will attract attention for sure. whether sporting or cultural events, fairs, open houses or sales promotions, the mobile giant- and tripole will catch everybody's eye for sure. pole and bars are made of anodized aluminium. the plastic base can be filled with water or sand and when filled giant- and tripole withstand wind speed up to 14m/s (50,4km/h). set base and pole together in no time. mount the flag and extend the telescopic flagstaff, that's it.



flag not included



in materiale plastico e alluminio anodizzato, anelli per il fissaggio inclusi.

kunststoff und eloxiertes aluminium, inkl. befestigungsringe.

plastic and anodized aluminium, incl. snap rings for flag.

## information

braccio telescopico retraibile per un facile fissaggio della bandiera.

teleskopauszug eingezogen zur mühelosen befestigung der fahne.

telescopic flagstaff for comfortable flag mounting.

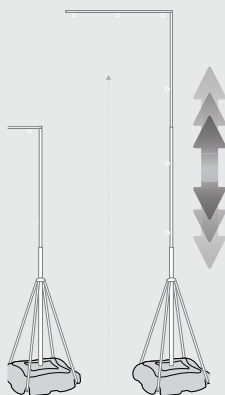

	giantpole	tripole
asta - mast - pole	min. 1600mm max. 5400mm	min. 1500mm max. 4000mm
base - basis - base	800x800x200mm	650x650x200mm
asta - mast - pole	5,9kg	2,9kg
base - basis - base	5,0kg / 70 lit.	3,0kg / 45 lit.
bandiera - fahne - flag standard mm	1100x3300mm	800x2400mm
bandiera - fahne - flag max. mm	1100x3900mm	800x2900mm
bandiera - fahne - flag max. kg	1000g	800g



## tripole & giantpole

1	TP40024080	tripole set, 1pc
2	GP450330110	giantpole set, 1pc

1

pirata



flag not included

# pirata

MADE IN EU design by KD

**IT** asta portabandiera cilindrica con dispositivo interno per issare la bandiera, braccio girevole telescopico, adatta per essere interrata nel cemento. la bandiera viene issata verticalmente sull'asta grazie ai tiranti. peso antisollevamento. riavvolgimento della bandiera facile e veloce. alluminio anodizzato di alta qualità in colore argento. dimensioni consigliate della bandiera: 3000x1200mm.

**DE** zylindrischer fahnenmast mit innenliegender, abschliessbarer hissvorrichtung und hissbarem, teleskopischem drehausleger, bodenhülse zum einbetonieren, vertikale fahnentuchführung durch gurtschlaufen am mast, gewicht gegen hochwehen und leichtes einholen der fahne, aus hochwertigem silber eloxiertem aluminium. empfohlenes fahnenmaß: 3000x1200mm.

**EN** cylindrical flagpole with internal, lockable winch and telescopic, turnable flag arm. flag arm can be taken up and down. ground sleeve to set in concrete, vertical guidance of the flag on the pole, weight to protect the flag from flying up and to take it easily down. made of high-grade silver anodized aluminium. recommended flag size: 3000x1200mm.



## information

supporto della base da interrare incluso  
*hülse zum einbetonieren inkl.*  
**ground sleeve to set in concrete incl.**

- larghezza dell'orlo 80 mm per il tubo di Ø 40mm  
 - max. 1m  
 - moschettoni per i tiranti sull'asta

-saumbreite 80mm für rohr Ø40mm  
 -max. 1m  
 -karabinerhaken für gurtschlaufen

-flag border 80mm for tube Ø40mm  
 -max. 1m  
 -carabiner hooks for straps

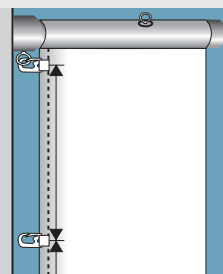
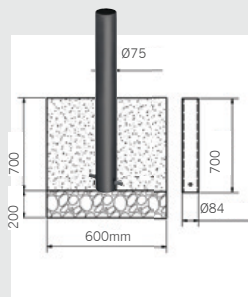

pirata



1 DFP6000A \*)

pirata flagpole, 1pc

\*) merce voluminosa oltre 7m di lunghezza: l'indirizzo di consegna deve essere facilmente raggiungibile con grandi mezzi di trasporto. ritiro con vs corriere e/o spedizione assieme ad altra merce non possibile.

\*) sperrgut überlänge 7m: zustellungsort muss für lkw erreichbar sein, keine selbstabholung, kein versand mit anderen waren

\*) bulk goods of 7m in length: delivery address must be accessible to large trucks, no ex works collections possible, no shipping along with other goods